

SDPF.0900

An innovative linear drain, designed specifically for poured floors such as Epoxy Resin and Micro Cement. This is a ground breaking design to cater for the requirements of poured floors..



Specification

MATERIAL	GRATING	CAPACITY
Plastic, Stainless Steel and Cast Solid Surface	Poured floor applied onto PourFlex Panel	32 l/min
USAGE	REMOVABLE TRAP FOR CLEANING	FLOORING
Linear drain	Yes	Poured or Plastered Floor e.g. Epoxy Resin, Micro Cement etc.
WATER TRAP HEIGHT		
50mm		

SDPF.0900

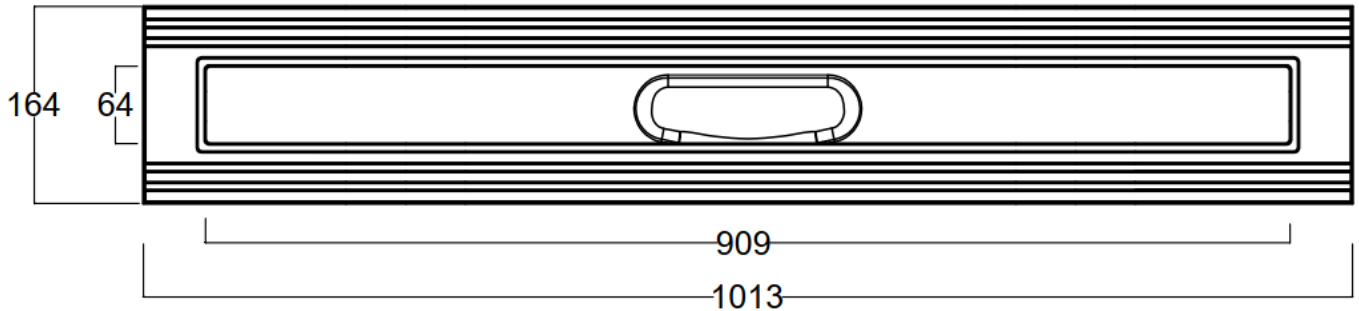

Plan

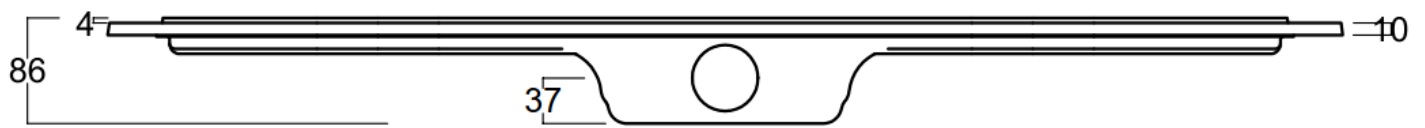

Front

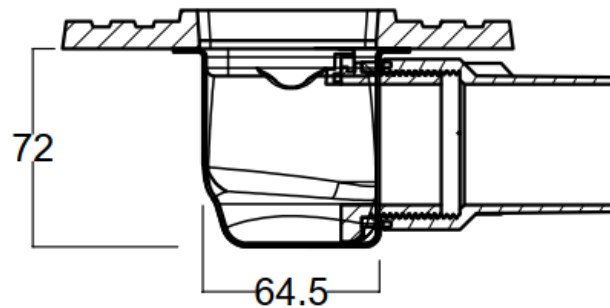

Side