

SharpDrain® Pro | Linear

Tile Insert / Panel

PSDTP.1100

New and improved SharpDrain with 360 rotating offset outlet for tricky joists and easy connection. The drain can be rotated to have the outlet offset on the opposite site. Factory fitted membrane for added waterproof protection. Available as Brushed Panel or Steel Tile Insert.



Specification

MATERIAL

Stainless Steel and Plastic

GRATING

Brushed Stainless Steel Panel and tile insert

CAPACITY

48 l/min

USAGE

LINEAR DRAIN

MEMBRANE

FACTORY FITTED SHEET MEMBRANE

FLOORING

TILES

WATER TRAP HEIGHT

50mm

REMOVABLE TRAP FOR CLEANING

YES

OUTLET

360° ROTATING OUTLET

SharpDrain® Pro | Linear

Tile Insert / Panel

PSDTP.1100

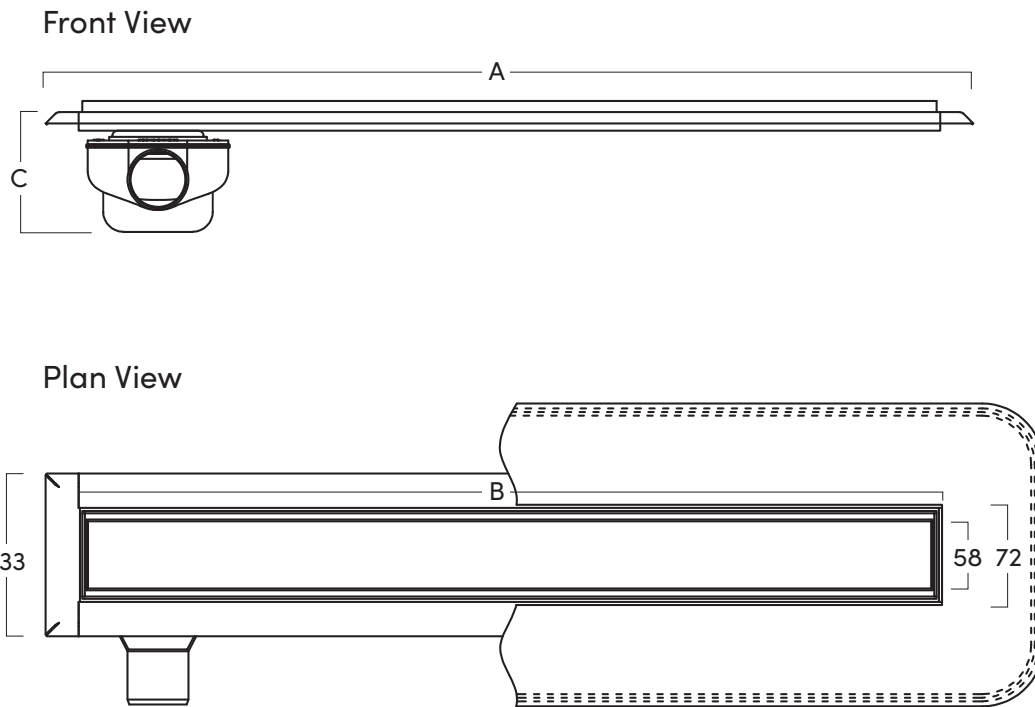

STRUCTURAL LENGTH - A

1160mm

VISUAL LENGTH - B

1000mm

DRAIN DEPTH - C

99mm