

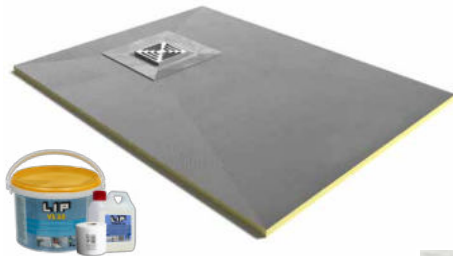









## SS.1010

### Kit Size 1000mm x 1000mm

Easy to install, preformed wetroom tray with integrated steel drain which is sealed with a watertight gasket. The preformed rigid tray is waterproof and has a cementitious top layer for high compression strength. Tile Inserts and Panels are available as Brushed Stainless Steel or durable PVD coated colours. Supplied with a high quality, flexible waterproofing membrane.

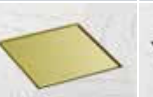

See next page for technical information

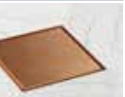
					
Steel Tile Insert Kit Order Ref	Black Tile Insert Kit Order Ref	Brass Tile Insert Kit Order Ref	Nickel Tile Insert Kit Order Ref	Bronze Tile Insert Kit Order Ref	
					
Frame & Grate Kit Order Ref	Steel Panel Kit Order Ref	Black Panel Kit Order Ref	Brass Panel Kit Order Ref	Nickel Panel Kit Order Ref	Bronze Panel Kit Order Ref
SS.1010FG	SS.1010SS	SS.1010BL	SS.1010BS	SS.1010NI	SS.1010BZ

## Specification

<b>MATERIAL</b> Extruded polystyrene (XPS) with cement coating, stainless steel, PP (Plastic)	<b>GRATING</b> Brushed Stainless Steel. PVD Coated colours	<b>CAPACITY</b> 42 l/min
<b>USAGE</b> Wetroom kit with Square drain	<b>MEMBRANE</b> Liquid membrane and Sheet membrane	<b>FLOORING</b> Minimum Tile Thickness 8mm
<b>WATER SEAL</b> 50mm	<b>REMOVABLE TRAP FOR CLEANING</b> Yes	<b>BOARD HEIGHT</b> 22mm

## SS.1010 - Wetroom Kit

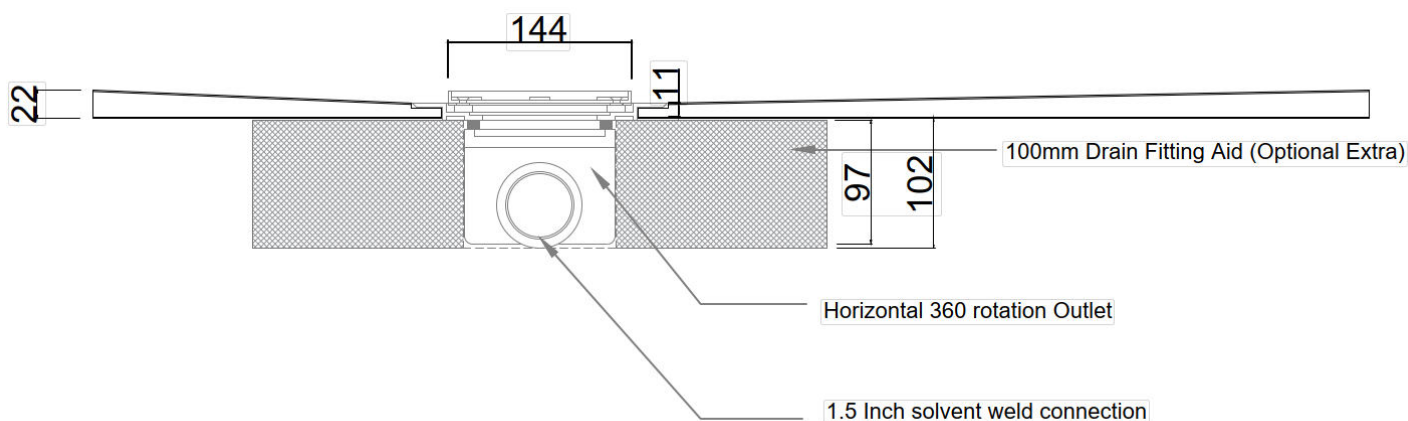
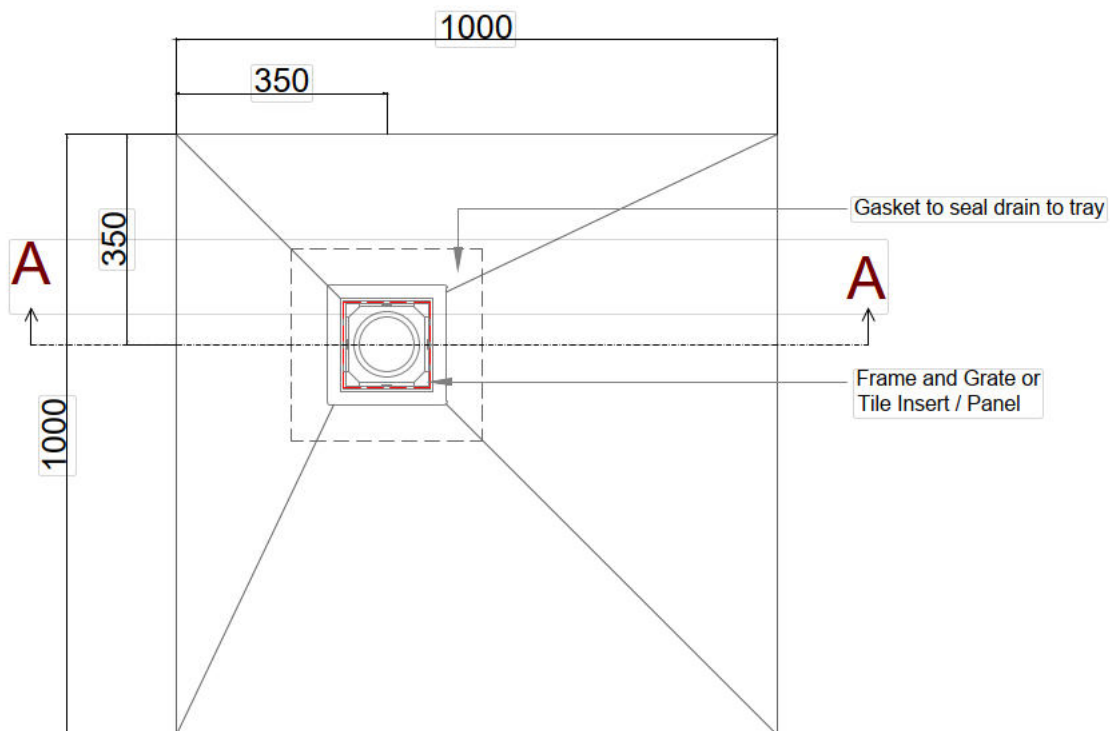

## WMVS30K - Waterproofing Kit

Easy application paint on liquid membrane for waterproofing wet rooms and bathrooms

Contains 3kg liquid membrane, 25m reinforcement trap and 1l primer.



### Specifications

**Material:** acrylic polymers, plasticizer, water and preservative

**Coverage:** 1.75m<sup>2</sup>

**Can be applied to:** Wood, concrete, metal, plastic, plaster, light clincer concrete, screed, lightweight concrete, stucco, gypsum floors, calcium, silicate plates and various approved wet room plaster boards, gypsum fibre, cement and polystyrene.

**Drying time:** 1st layer 1-2 hours at 18-20°C. 2nd layer approx 12 hours at 18-20°C.  
Drying times will vary depending on temperature, ventilation and substrate.

**Application method:** Paint brush and roller.

**Notes:** Room must be primed with Primer 54 included before applying liquid membrane. All major joints must be reinforced using LIP reinforcement tape included. Ensure all areas are dry after each stage before proceeding i.e. Priming, 1st coat and 2nd coat before proceeding. No one can access the area whilst membrane is drying. Once 2nd coat is completely dry, cover membrane with a suitable protective sheet / board until tiled. If a heater is required, do not place too close to the membrane.

**Refer to installation instructions and safety data sheet for more information.**