

1004.1400K1SQ Standard Outlet  
DATA SHEET



**KIT CONTAINS**

WALL MOUNTED DRAIN  
MULTI DIRECTIONAL OUTLET  
CLASSICLINE FRAME  
SQUARE GRATE

## 1004.1401 - 1400 Model Drain Body

Line 1004

Wall Mounted Linear Drain fixed to wall for a very secure installation and to allow for a one way fall. Suitable for 25mm wall build up. For larger sizes, please contact Wet Room Materials. Can be freely positioned against rear wall, independent of any side walls.



### Specifications

<b>ITEM NUMBER</b>	<b>GTIN NUMBER</b>	<b>MATERIAL</b>
1004.1401	5707692008387	1.5 mm stainless steel (AISI 304)
<b>USAGE</b>	<b>SURFACE</b>	<b>MEMBRANE</b>
Linear drain	Pickled	Liquid or sheet membrane
<b>FLOOR CONSTRUCTION</b>	<b>FLOORING</b>	<b>MOUNTING</b>
All	Tiles	6 mm Pluks 6 mm Skruer. Torx 20
<b>CENTER</b>	<b>INSTALLATION LENGTH (L)</b>	<b>HEIGHT (H)</b>
406 mm	1509 mm	17 mm
<b>LENGTH MODEL</b>		
1400		

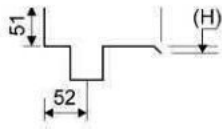
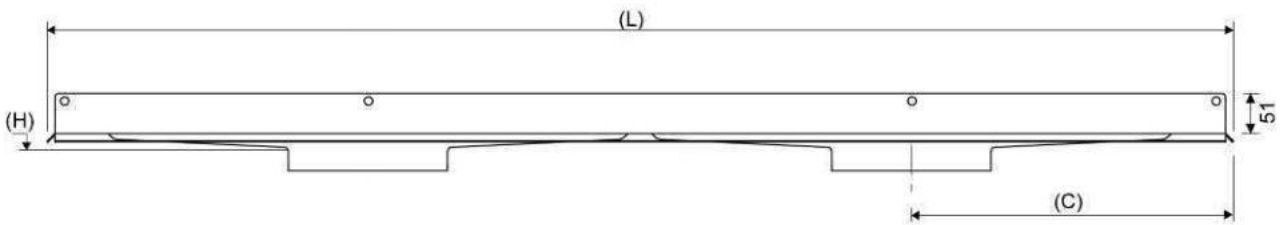
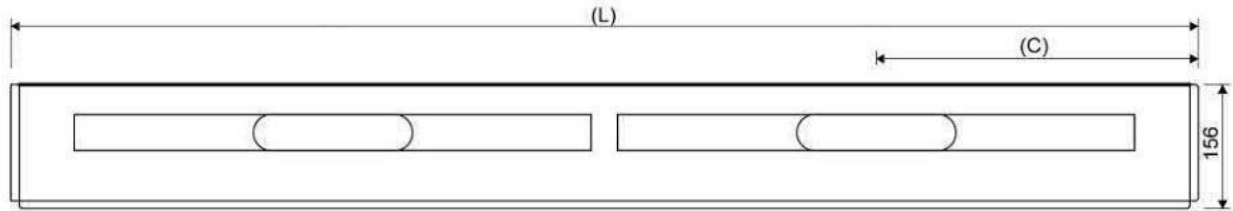

## 1416.0050 - Multi Directional Outlet

Line 1416.0050

Ø 50 mm horizontal drain

Can be rotated 180 degrees if a rear-facing outlet is required.

Note two drains. Cannot be used as an inlet.



### Specifications

ITEM NUMBER	GTIN NUMBER	WEIGHT INCLUDING PACKAGING
1416.0050	5707692012520	505 g
WEIGHT EXCLUDING PACKAGING	MATERIAL	USAGE
312 g	Plastic (PP)	Line drain
BARRIER	GASKET	CAPACITY
With	EPDM	0,8 l/s
SIDE INLET	CENTER	FITS DRAIN UNIT
Without	32 mm	1001, 1002, 1003, 1004, 1100, 3002, 3004, 5002, 5003, 4004

FITTING HEIGHTS - LINE FAUCETS 1001, 1002, 1003, 1004

Ø	Outlet direction	300	600	700	800	900	1000	1200
Ø 50 mm	Horizontal	98 mm	102 mm	103 mm	104 mm	105 mm	106 mm	108 mm

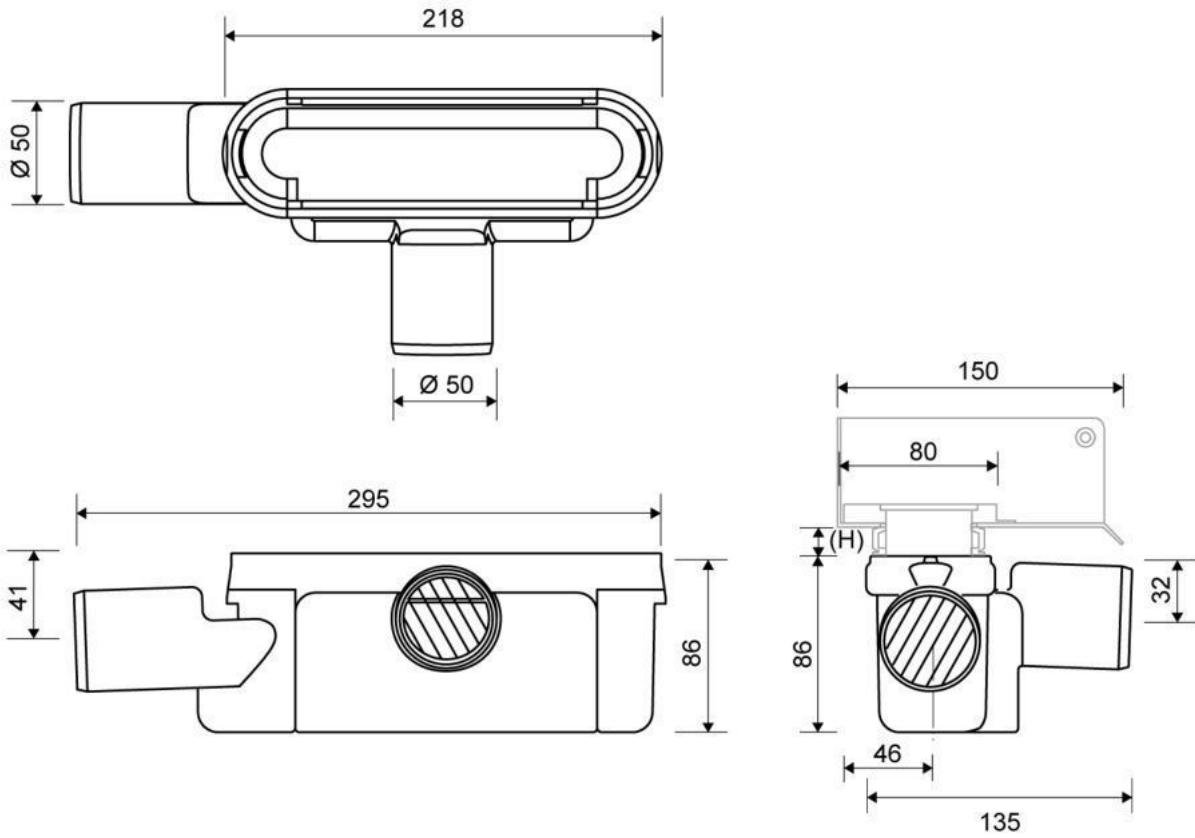

**WM | Wetroom Materials**

[www.wetroommaterials.com](http://www.wetroommaterials.com) [sales@wetroommaterials.com](mailto:sales@wetroommaterials.com)

UK: Derwentside, 25 Town Street, Duffield, Belper, Derbyshire, DE56 4EH T: +44 (0) 1332 840 820  
IRE: Unit E1 Ballymount Industrial Estate, Walkinstown, Dublin 12, D12 WR60 T: +353 (0) 1 297 3488

## 1500.0712 - 700mm Classic Line Frame

Line 1500

Brushed Stainless Steel Classicline Frame to be used with all Classicline grates. Also available with as 8 and 10mm frame heights (depending on thickness of floor tile)



### Specifications

ITEM NUMBER	GTIN NUMBER	WEIGHT INCLUDING PACKAGING
1500.0712	5707692003290	900 g
WEIGHT EXCLUDING PACKAGING	MATERIAL	USAGE
720 g	Stainless steel (AISI 304)	Line drain
SURFACE	INSTALLATION LENGTH (L)	HEIGHT (H)
Brushed	695 mm	H 12 mm
LENGTH MODEL	FITS DRAIN UNIT	INSERT
700 mm	1001, 1002, 1003, 1004, 1100, 5002, 5003	Synthetic

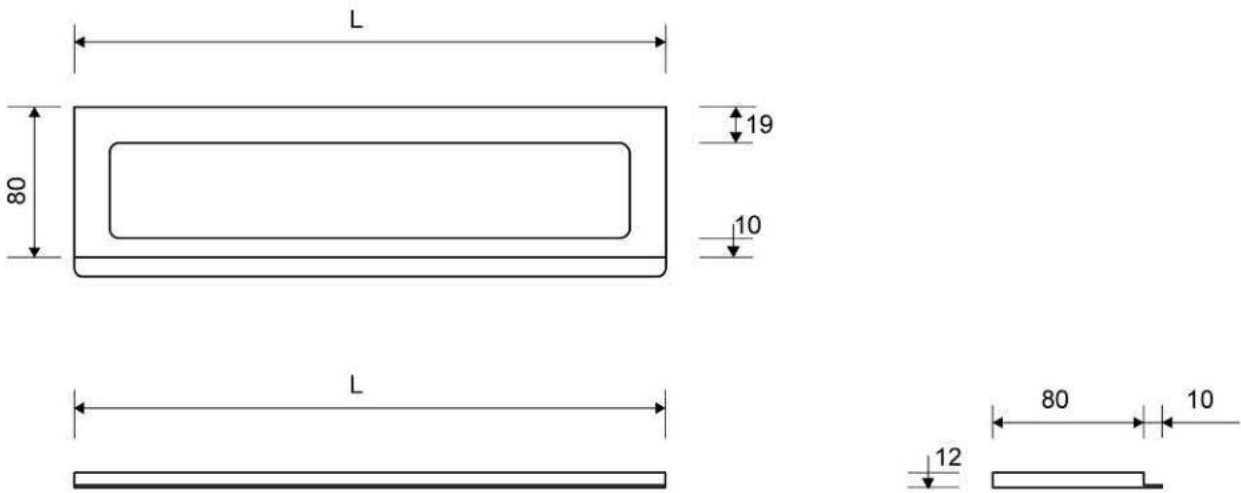

## 1604.0700 - 700mm Square Grate

Line 1600

Brushed Stainless Steel grate to be placed onto Classicline Frame

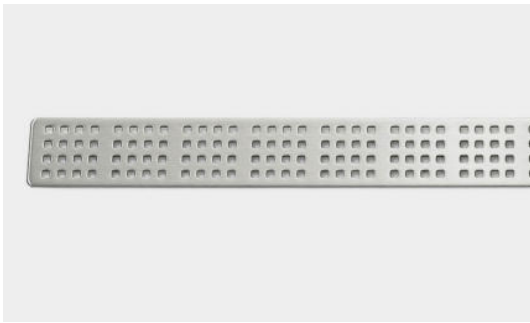

### Specifications

<b>ITEM NUMBER</b>	<b>LENGTH MODEL</b>	<b>WEIGHT INCLUDING PACKAGING</b>
1604.0700	700 mm	280 g
<b>WEIGHT EXCLUDING PACKAGING</b>	<b>MATERIAL</b>	<b>SURFACE</b>
240 g	Stainless steel (AISI 304)	Brushed



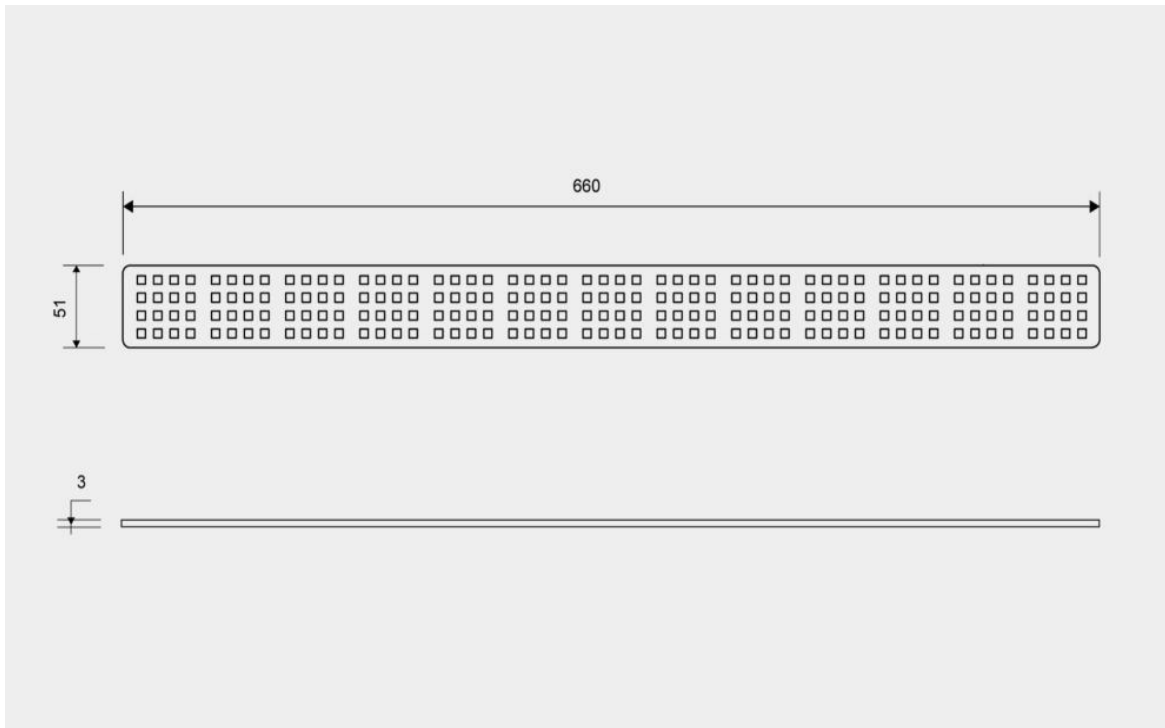

**1604.0700**

Products