

1004.0800K1STM01 Low Outlet
DATA SHEET



KIT CONTAINS

WALL MOUNTED DRAIN
LOW PROFILE OUTLET
CLASSICLINE FRAME
STRIPE GRATE



WM | Wetroom Materials

www.wetroommaterials.com sales@wetroommaterials.com

UK: Derwentside, 25 Town Street, Duffield, Belper, Derbyshire, DE56 4EH T: +44 (0) 1332 840 820
IRE: Unit E1 Ballymount Industrial Estate, Walkinstown, Dublin 12, D12 WR60 T: +353 (0) 1 297 3488

1004.0801 - 800 Model Drain Body

Line 1004

Wall Mounted Linear Drain fixed to wall for a very secure installation and to allow for a one way fall. Suitable for 25mm wall build up. For larger sizes, please contact Wet Room Materials. Can be freely positioned against rear wall, independent of any side walls.



Specifications

ITEM NUMBER	GTIN NUMBER	MATERIAL
1004.0801	5707692008394	1.5 mm stainless steel (AISI 304)
USAGE	SURFACE	MEMBRANE
Linear drain	Pickled	Liquid or sheet membrane
FLOOR CONSTRUCTION	FLOORING	MOUNTING
All	Tiles	6 mm Pluks 6 mm Skruer. Torx 20
CENTER	INSTALLATION LENGTH (L)	HEIGHT (H)
456 mm	912 mm	18 mm
LENGTH MODEL		
800		

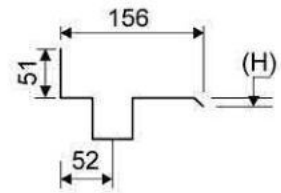
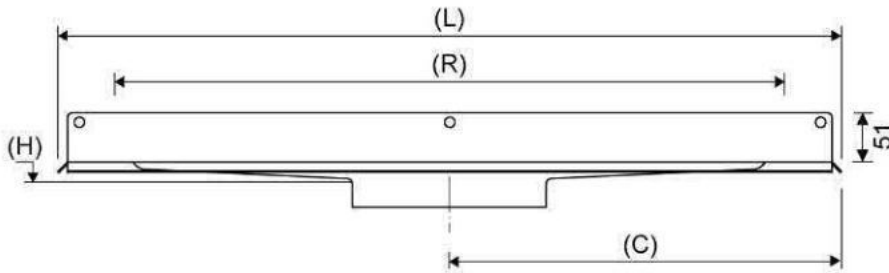
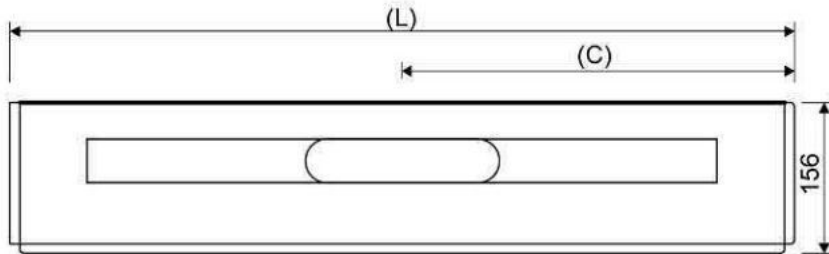

1417.0050 - Low Profile Outlet

Linear 1417.0050

Ø 50 mm horizontal drain

The odour barrier can be removed for cleaning

Can be rotated 180 degrees if a rear-facing outlet is required

Note: Odour barrier is VA-approved



Specifications

ITEM NUMBER	GTIN NUMBER	WEIGHT INCLUDING PACKAGING
1417.0050	5707692007915	500 g
WEIGHT EXCLUDING PACKAGING	MATERIAL	USAGE
350 g	Plastic (PP)	Line drain
BARRIER	GASKET	CAPACITY
With (odour barrier)	EPDM	0.6 l/s
SIDE INLET	CENTER	FITS DRAIN UNIT
Without	30 mm	1001, 1002, 1003, 1004, 1100, 3002, 3004, 5002, 5003, 4004

FITTING HEIGHTS - LINE FAUCETS 1001, 1002, 1003, 1004

Ø	Outlet direction	300	600	700	800	900	1000	1200
Ø 50 mm	Horizontal	64 mm	68 mm	69 mm	70 mm	71 mm	72 mm	74 mm

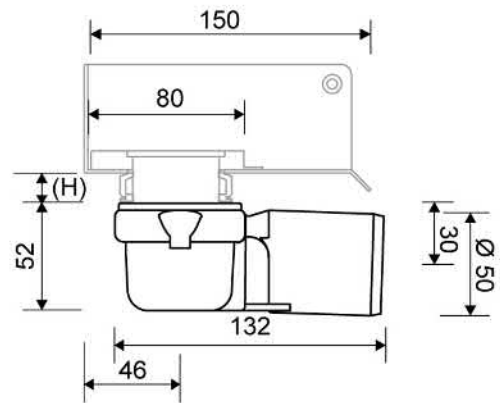
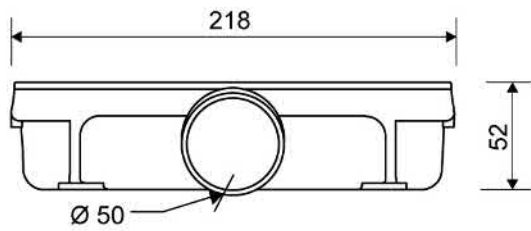
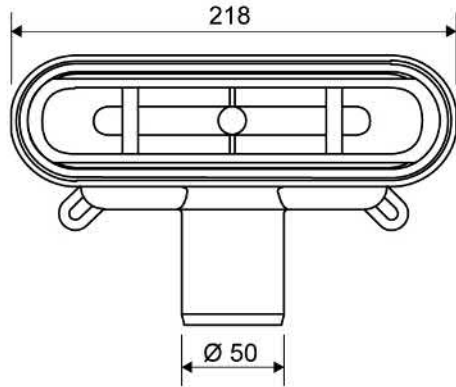

1500.0812 - Classic Line Frame

Line 1500

Brushed Stainless Steel Classicline Frame to be used with all Classicline grates. Also available with as 8 and 10mm frame heights (depending on thickness of floor tile)



Specifications

ITEM NUMBER	GTIN NUMBER	WEIGHT INCLUDING PACKAGING
1500.0812	5707692003320	1010 g
WEIGHT EXCLUDING PACKAGING	MATERIAL	USAGE
820 g	Stainless steel (AISI 304)	Line drain
SURFACE	INSTALLATION LENGTH (L)	HEIGHT (H)
Brushed	795 mm	H 12 mm
LENGTH MODEL	FITS DRAIN UNIT	INSERT
800 mm	1001, 1002, 1003, 1004, 1100, 5002, 5003	Synthetic

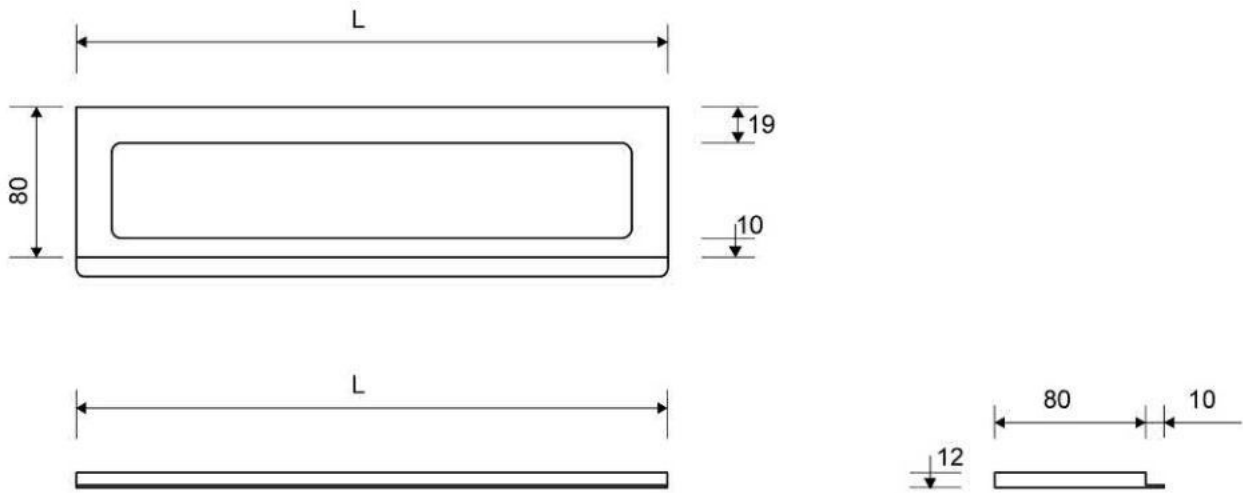

1605.0800 - 800mm Square Grate

Line 1600

Brushed Stainless Steel grate to be placed onto Classicline Frame

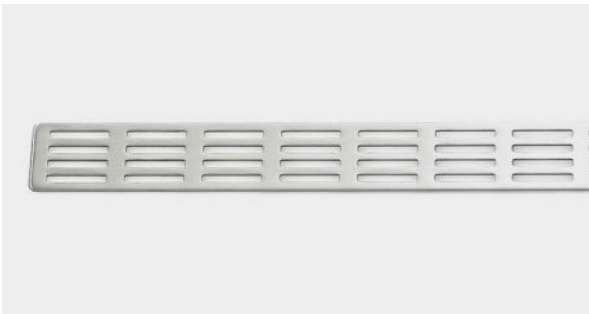

Specifications

ITEM NUMBER 1605.0800	LENGTH MODEL 800 mm	WEIGHT INCLUDING PACKAGING 280 g
WEIGHT EXCLUDING PACKAGING 240 g	MATERIAL Stainless steel (AISI 304)	SURFACE Brushed

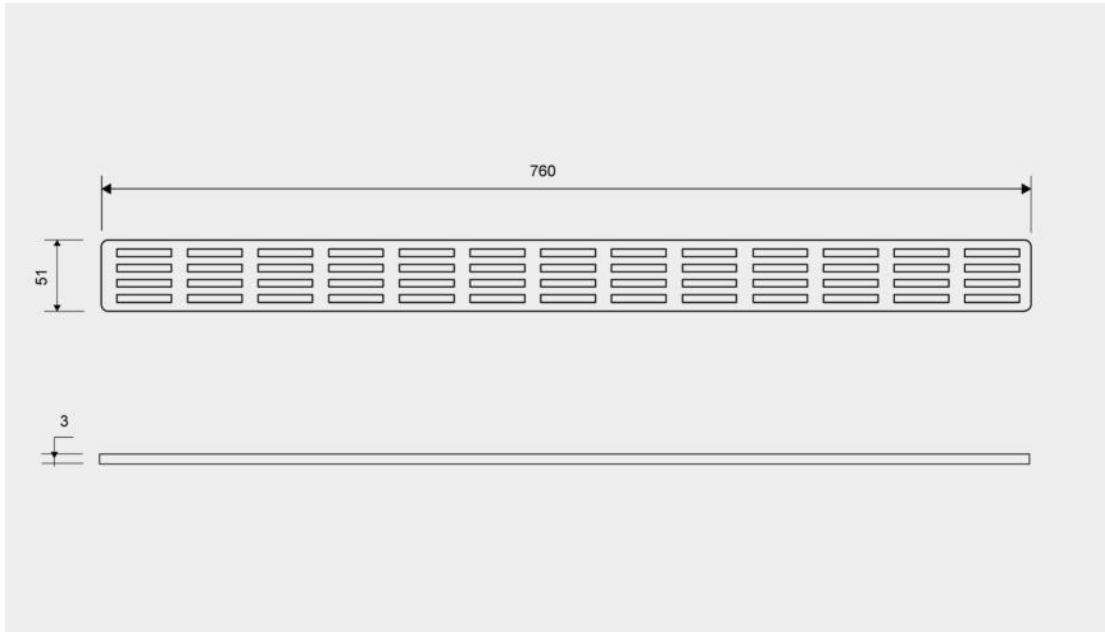

1605.0800

Products