

KIT CONTAINS

FREESTANDING DRAIN
INSTALLATION FEET
LOW PROFILE OUTLET
CLASSICLINE FRAME
STRIPE GRATE

WM | Wetroom Materials

www.wetroommaterials.com sales@wetroommaterials.com

UK: Derwentside, 25 Town Street, Duffield, Belper, Derbyshire, DE56 4EH T: +44 (0) 1332 840 820
IRE: Unit E1 Ballymount Industrial Estate, Walkinstown, Dublin 12, D12 WR60 T: +353 (0) 1 297 3488

3004.1000 - 1000 Model Drain Body

Line 3004

For shower cubicle with no permanent walls



Specifications

ITEM NUMBER	GTIN NUMBER	WEIGHT INCLUDING PACKAGING
3004.1000	5707692007083	4300 g
WEIGHT EXCLUDING PACKAGING	MATERIAL	USAGE
4100 g	1,5 mm stainless steel (AISI 304)	Line drain
SURFACE	MEMBRANE	FLOOR CONSTRUCTION
Pickled	Liquid or sheet membrane	All
FLOORING	MOUNTING	CENTER
Tiles	6 mm plugs 6 mm screws. Torx 20	556 mm
INSTALLATION LENGTH (L)	HEIGHT (H)	LENGTH MODEL
1112 mm	20 mm	1000 mm

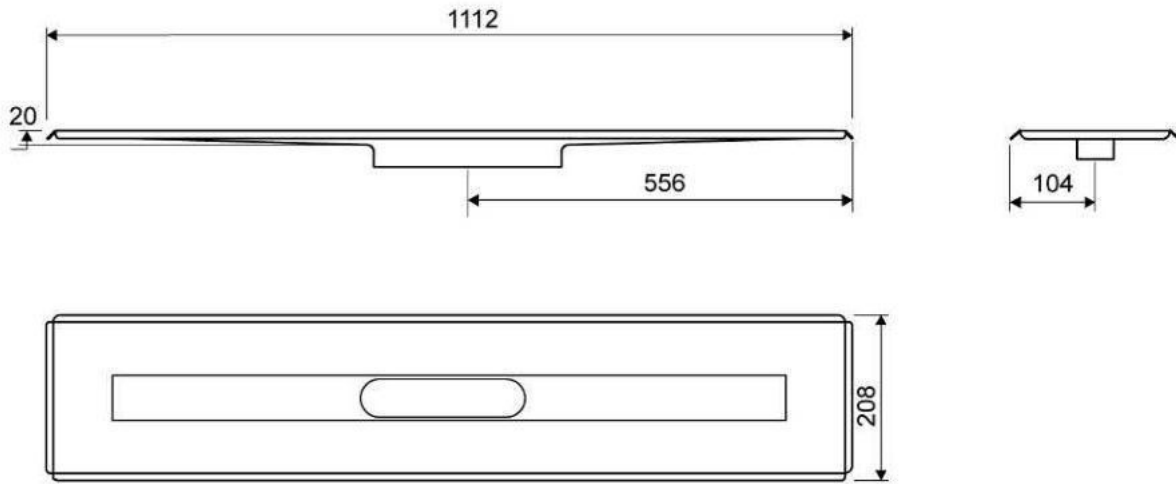

3004.1000

Height Adjustable Installation Feet

Height-adjustable feet (120-220 mm) for installation in concrete.
included with 3004 Unidrain.

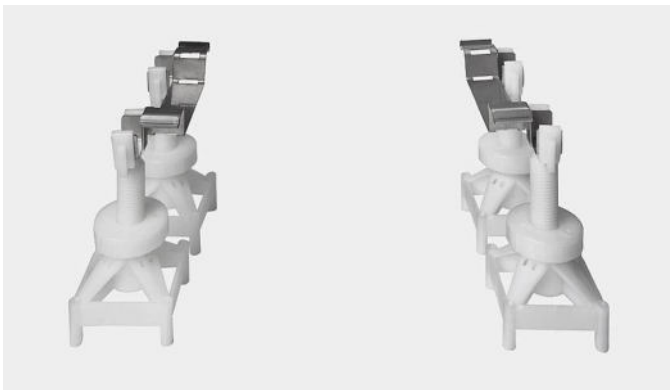

1417.0050 - Low Profile Outlet

Linear 1417.0050

Ø 50 mm horizontal drain

The odour barrier can be removed for cleaning

Can be rotated 180 degrees if a rear-facing outlet is required

Note: Odour barrier is VA-approved



Specifications

ITEM NUMBER	GTIN NUMBER	WEIGHT INCLUDING PACKAGING
1417.0050	5707692007915	500 g
WEIGHT EXCLUDING PACKAGING	MATERIAL	USAGE
350 g	Plastic (PP)	Line drain
BARRIER	GASKET	CAPACITY
With (odour barrier)	EPDM	0.6 l/s
SIDE INLET	CENTER	FITS DRAIN UNIT
Without	30 mm	1001, 1002, 1003, 1004, 1100, 3002, 3004, 5002, 5003, 4004

FITTING HEIGHTS - LINE FAUCETS 1001, 1002, 1003, 1004

Ø	Outlet direction	300	600	700	800	900	1000	1200
Ø 50 mm	Horizontal	64 mm	68 mm	69 mm	70 mm	71 mm	72 mm	74 mm

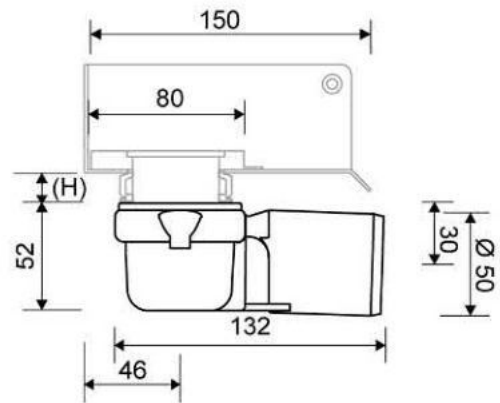
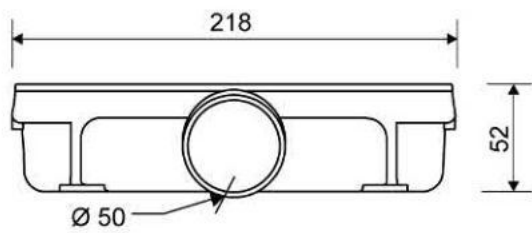
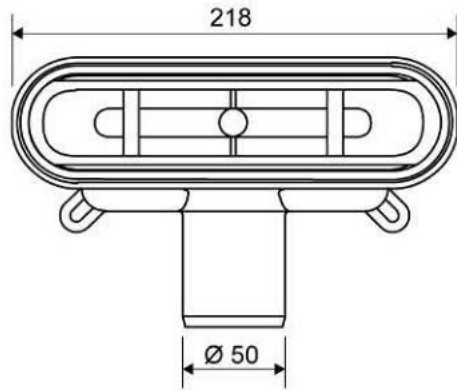

3500.1012 - 1000 Classicline Frame

Line 3500 | ClassicLine

Available in 8, 10 and 12 mm heights (depending on the thickness of the floor tile)



Specifications

ITEM NUMBER	GTIN NUMBER	MATERIAL
3500.1012	5707692008851	Stainless steel (AISI 304)
USAGE	SURFACE	INSTALLATION LENGTH (L)
Line drain	Brushed	995 mm
HEIGHT (H)	LENGTH MODEL	FITS DRAIN UNIT
H 12 mm	1000 mm	3004
INSERT		
Synthetic		

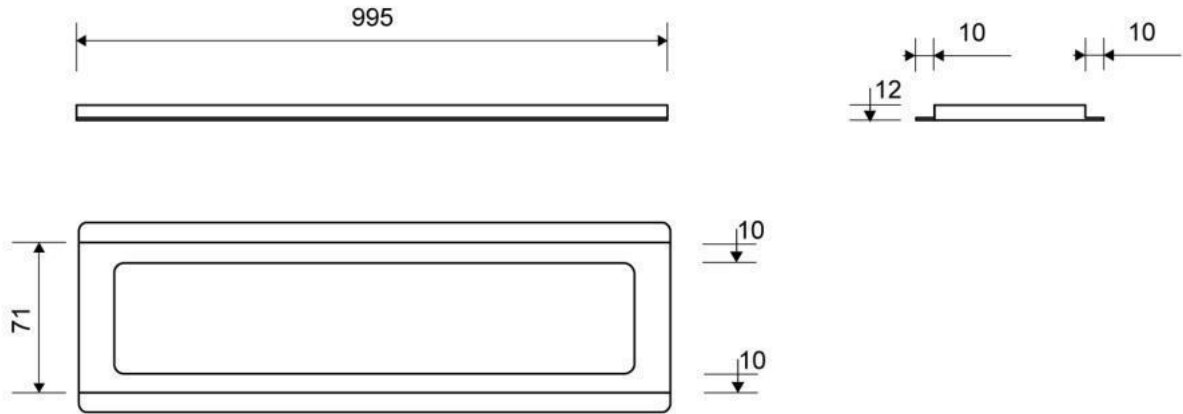

3500.1012

Products

1605.1000 - 1000mm Square Grate

Line 1600

Brushed Stainless Steel grate to be placed onto Classicline Frame

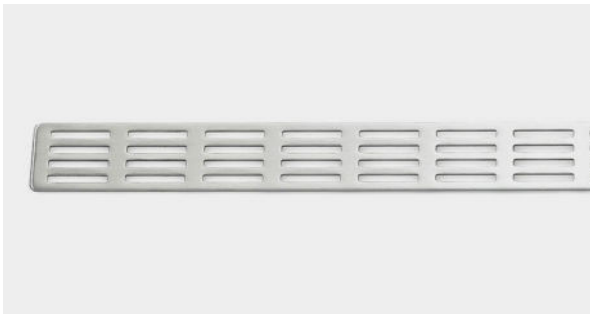

Specifications

ITEM NUMBER	LENGTH MODEL	WEIGHT INCLUDING PACKAGING
1605.1000	1000 mm	280 g
WEIGHT EXCLUDING PACKAGING	MATERIAL	SURFACE
240 g	Stainless steel (AISI 304)	Brushed

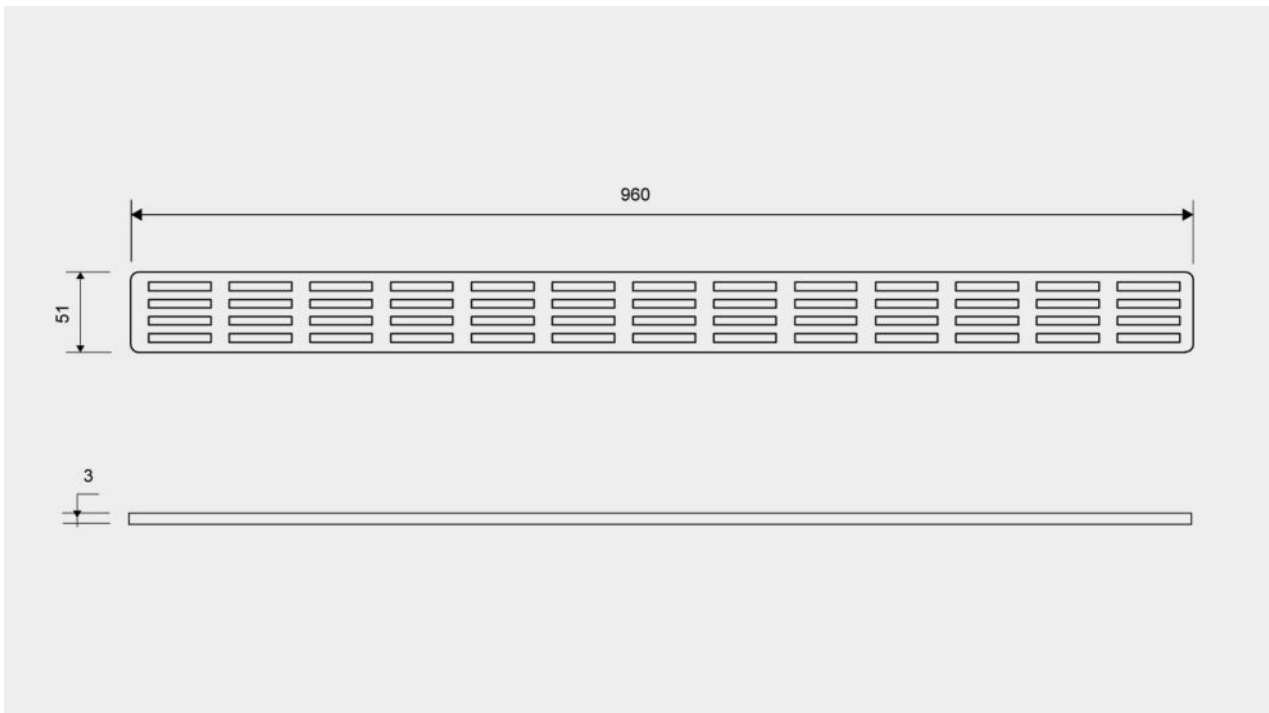

1605.1000

Products