

1004.2400K1ST Standard Outlet DATA SHEET



KIT CONTAINS

WALL MOUNTED DRAIN
MULTI DIRECTIONAL OUTLET
CLASSICLINE FRAME
STRIPE GRATE

WM | Wetroom Materials

www.wetroommaterials.com sales@wetroommaterials.com

UK: Derwentside, 25 Town Street, Duffield, Belper, Derbyshire, DE56 4EH T: +44 (0) 1332 840 820
IRE: Unit E1 Ballymount Industrial Estate, Walkinstown, Dublin 12, D12 WR60 T: +353 (0) 1 297 3488

1004.1201 - 1200 Model Drain Body

Line 1004

Wall Mounted Linear Drain fixed to wall for a very secure installation and to allow for a one way fall. Suitable for 25mm wall build up. For larger sizes, please contact Wet Room Materials. Can be freely positioned against rear wall, independent of any side walls.



Specifications

ITEM NUMBER	GTIN NUMBER	MATERIAL
1004.1201	5707692008424	1.5 mm stainless steel (AISI 304)
USAGE	SURFACE	MEMBRANE
Linear drain	Pickled	Liquid or sheet membrane
FLOOR CONSTRUCTION	FLOORING	MOUNTING
All	Tiles	6 mm Pluks 6 mm Skruer. Torx 20
CENTER	INSTALLATION LENGTH (L)	HEIGHT (H)
656 mm	1312 mm	22 mm
LENGTH MODEL		
1200		

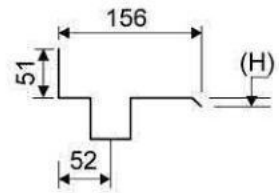
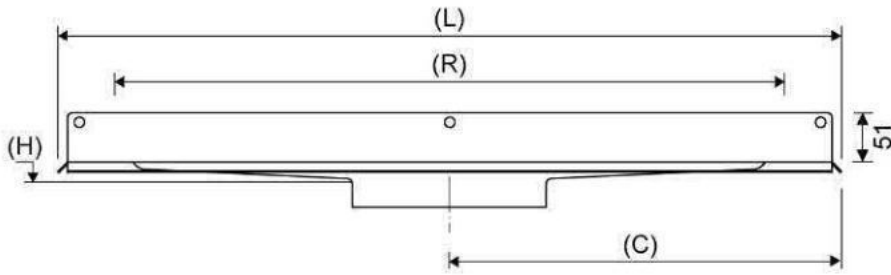
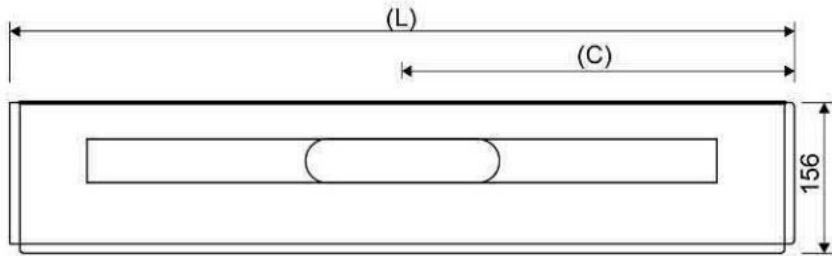

1416.0050 - Multi Directional Outlet

Line 1416.0050

Ø 50 mm horizontal drain

Can be rotated 180 degrees if a rear-facing outlet is required.

Note two drains. Cannot be used as an inlet.



Specifications

ITEM NUMBER	GTIN NUMBER	WEIGHT INCLUDING PACKAGING
1416.0050	5707692012520	505 g
WEIGHT EXCLUDING PACKAGING	MATERIAL	USAGE
312 g	Plastic (PP)	Line drain
BARRIER	GASKET	CAPACITY
With	EPDM	0,8 l/s
SIDE INLET	CENTER	FITS DRAIN UNIT
Without	32 mm	1001, 1002, 1003, 1004, 1100, 3002, 3004, 5002, 5003, 4004

FITTING HEIGHTS - LINE FAUCETS 1001, 1002, 1003, 1004

Ø	Outlet direction	300	600	700	800	900	1000	1200
Ø 50 mm	Horizontal	98 mm	102 mm	103 mm	104 mm	105 mm	106 mm	108 mm

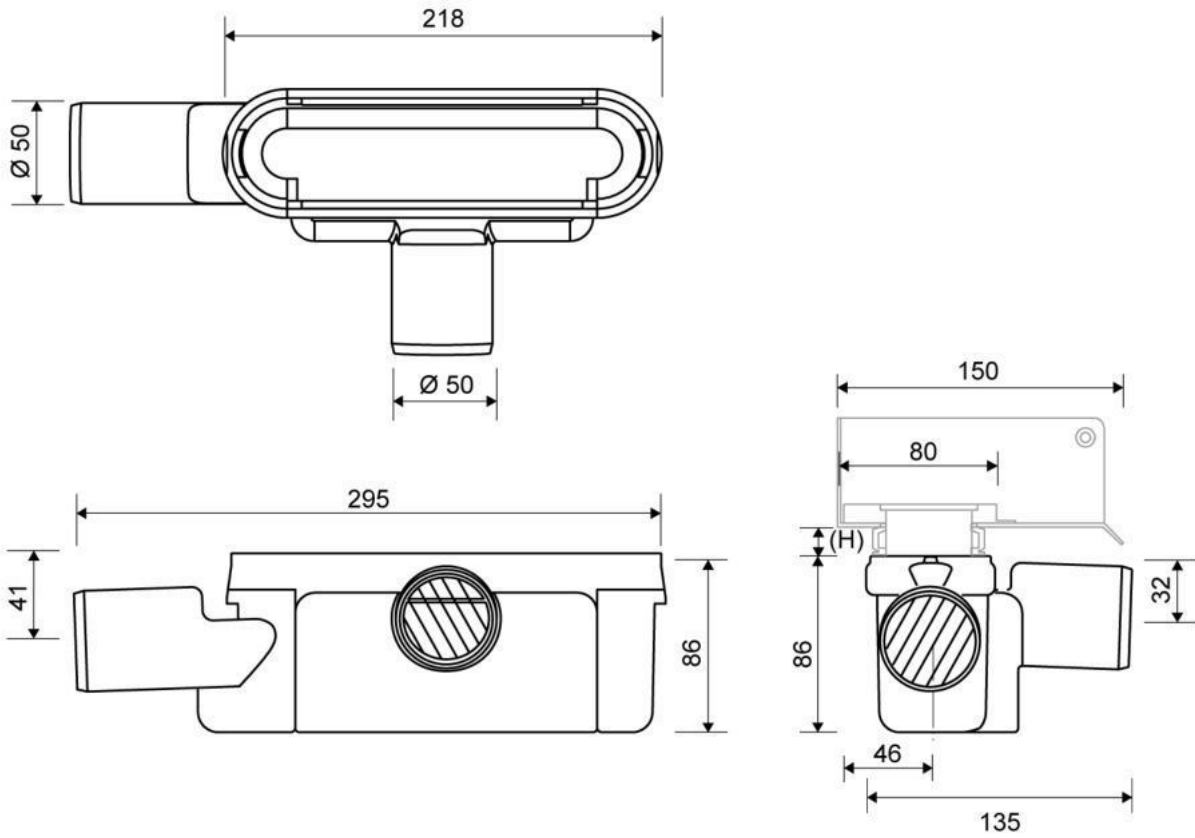

WM | Wetroom Materials

www.wetroommaterials.com sales@wetroommaterials.com

UK: Derwentside, 25 Town Street, Duffield, Belper, Derbyshire, DE56 4EH T: +44 (0) 1332 840 820
IRE: Unit E1 Ballymount Industrial Estate, Walkinstown, Dublin 12, D12 WR60 T: +353 (0) 1 297 3488

1500.1212 - 1200mm Classic Line Frame

Line 1500

Brushed Stainless Steel Classicline Frame to be used with all Classicline grates. Also available with as 8 and 10mm frame heights (depending on thickness of floor tile)



Specifications

ITEM NUMBER	GTIN NUMBER	WEIGHT INCLUDING PACKAGING
1500.1212	5707692003412	1500 g
WEIGHT EXCLUDING PACKAGING	MATERIAL	USAGE
1300 g	Stainless steel (AISI 304)	Line drain
SURFACE	INSTALLATION LENGTH (L)	HEIGHT (H)
Brushed	1195 mm	H 12 mm
LENGTH MODEL	FITS DRAIN UNIT	INSERT
1200 mm	1001, 1002, 1003, 1004, 1100, 5002, 5003	Synthetic

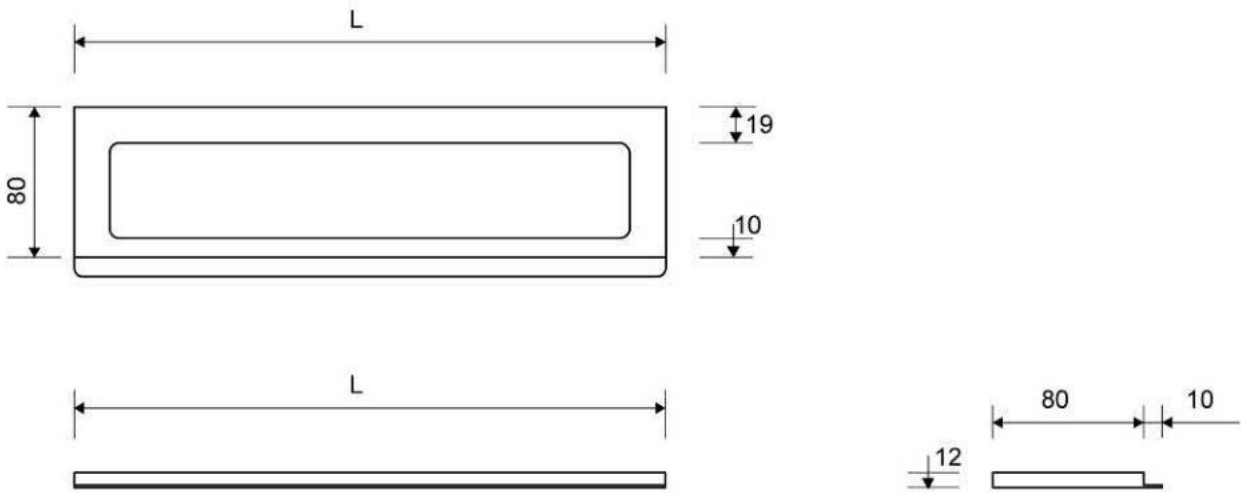

1605.1200 - 1200mm Square Grate

Line 1600

Brushed Stainless Steel grate to be placed onto Classicline Frame

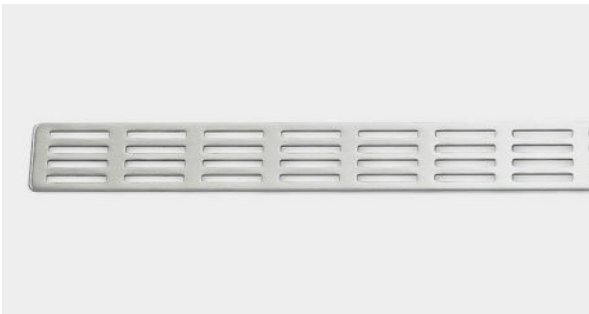

Specifications

ITEM NUMBER	LENGTH MODEL	WEIGHT INCLUDING PACKAGING
1605.1200	1200 mm	280 g
WEIGHT EXCLUDING PACKAGING	MATERIAL	SURFACE
240 g	Stainless steel (AISI 304)	Brushed

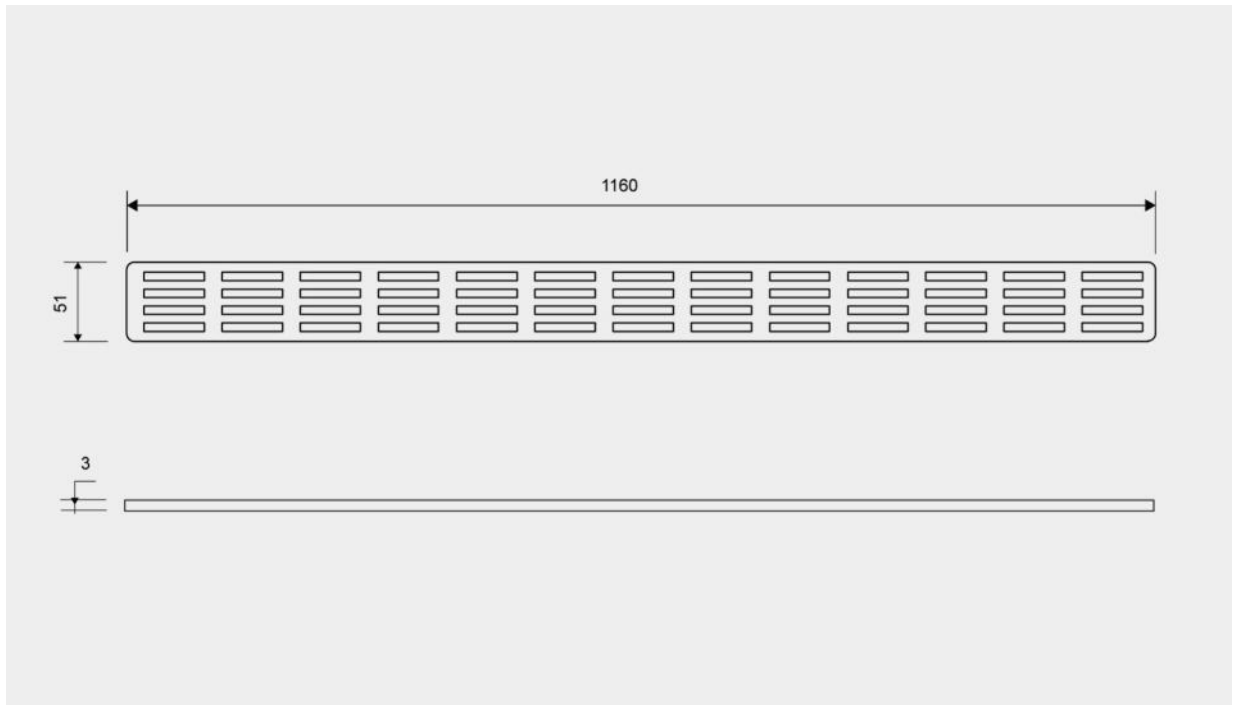

1605.1200

Products