

1004.0700K1 Standard Outlet DATA SHEET



KIT CONTAINS

WALL MOUNTED DRAIN
MULTI DIRECTIONAL OUTLET
CLASSICLINE FRAME
ANNIVERSARIO GRATE

WM | Wetroom Materials

www.wetroommaterials.com sales@wetroommaterials.com

UK: Derwentside, 25 Town Street, Duffield, Belper, Derbyshire, DE56 4EH T: +44 (0) 1332 840 820
IRE: Unit E1 Ballymount Industrial Estate, Walkinstown, Dublin 12, D12 WR60 T: +353 (0) 1 297 3488

1004.0701 - 700 Model Drain Body

Line 1004

Wall Mounted Linear Drain fixed to wall for a very secure installation and to allow for a one way fall. Suitable for 25mm wall build up. For larger sizes, please contact Wet Room Materials. Can be freely positioned against rear wall, independent of any side walls.



Specifications

ITEM NUMBER	GTIN NUMBER	MATERIAL
1004.0701	5707692008387	1.5 mm stainless steel (AISI 304)
USAGE	SURFACE	MEMBRANE
Linear drain	Pickled	Liquid or sheet membrane
FLOOR CONSTRUCTION	FLOORING	MOUNTING
All	Tiles	6 mm Pluks 6 mm Skruer. Torx 20
CENTER	INSTALLATION LENGTH (L)	HEIGHT (H)
406 mm	812 mm	17 mm
LENGTH MODEL		
700		

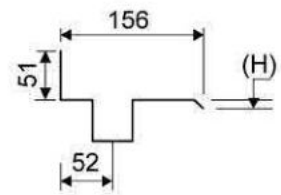
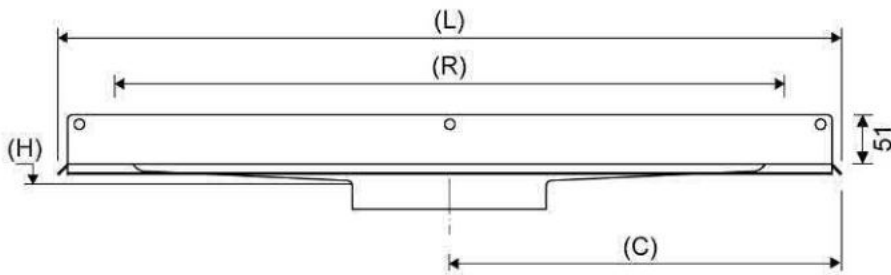
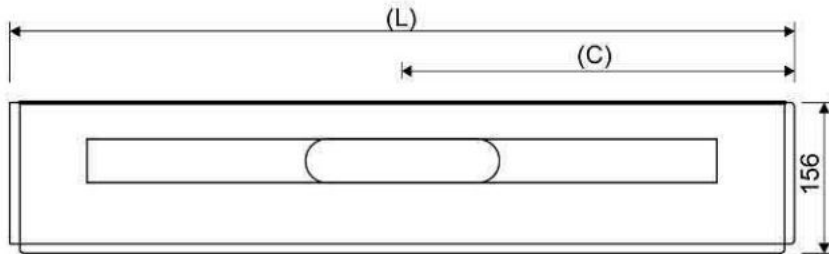

1416.0050 - Multi Directional Outlet

Line 1416.0050

Ø 50 mm horizontal drain

Can be rotated 180 degrees if a rear-facing outlet is required.

Note two drains. Cannot be used as an inlet.



Specifications

ITEM NUMBER	GTIN NUMBER	WEIGHT INCLUDING PACKAGING
1416.0050	5707692012520	505 g
WEIGHT EXCLUDING PACKAGING	MATERIAL	USAGE
312 g	Plastic (PP)	Line drain
BARRIER	GASKET	CAPACITY
With	EPDM	0,8 l/s
SIDE INLET	CENTER	FITS DRAIN UNIT
Without	32 mm	1001, 1002, 1003, 1004, 1100, 3002, 3004, 5002, 5003, 4004

FITTING HEIGHTS - LINE FAUCETS 1001, 1002, 1003, 1004

Ø	Outlet direction	300	600	700	800	900	1000	1200
Ø 50 mm	Horizontal	98 mm	102 mm	103 mm	104 mm	105 mm	106 mm	108 mm

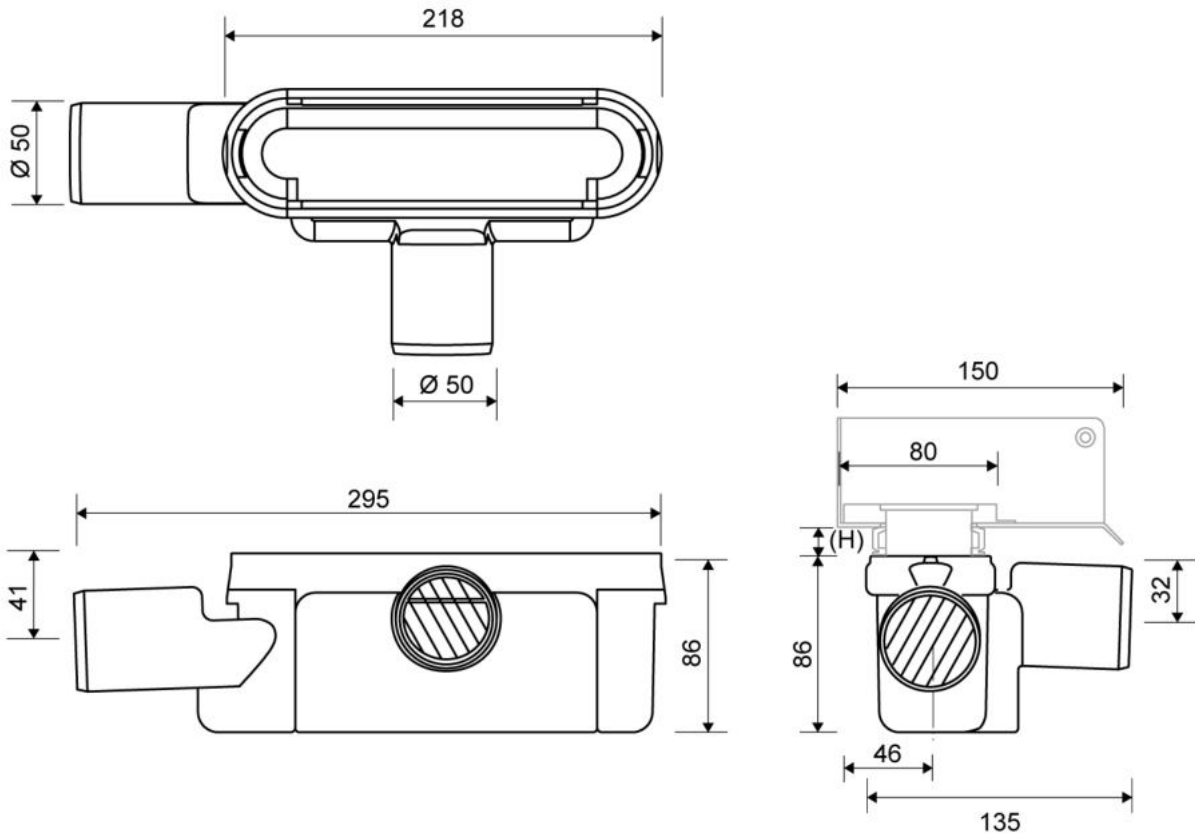

WM | Wetroom Materials

www.wetroommaterials.com sales@wetroommaterials.com

UK: Derwentside, 25 Town Street, Duffield, Belper, Derbyshire, DE56 4EH T: +44 (0) 1332 840 820
IRE: Unit E1 Ballymount Industrial Estate, Walkinstown, Dublin 12, D12 WR60 T: +353 (0) 1 297 3488

1500.0712 - Classic Line Frame

Line 1500

Brushed Stainless Steel Classicline Frame to be used with all Classicline grates. Also available with as 8 and 10mm frame heights (depending on thickness of floor tile)



Specifications

ITEM NUMBER	GTIN NUMBER	WEIGHT INCLUDING PACKAGING
1500.0712	5707692003290	900 g
WEIGHT EXCLUDING PACKAGING	MATERIAL	USAGE
720 g	Stainless steel (AISI 304)	Line drain
SURFACE	INSTALLATION LENGTH (L)	HEIGHT (H)
Brushed	695 mm	H 12 mm
LENGTH MODEL	FITS DRAIN UNIT	INSERT
700 mm	1001, 1002, 1003, 1004, 1100, 5002, 5003	Synthetic

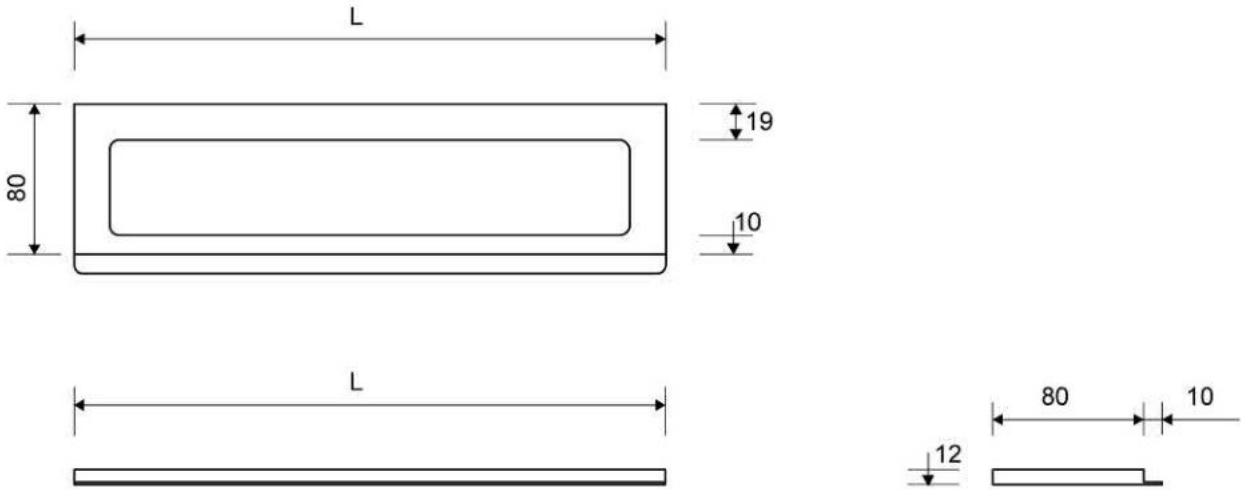

1606.0700 - 700mm Anniversario Grate

Line 1600

Brushed Stainless Steel grate to be placed onto Classicline Frame

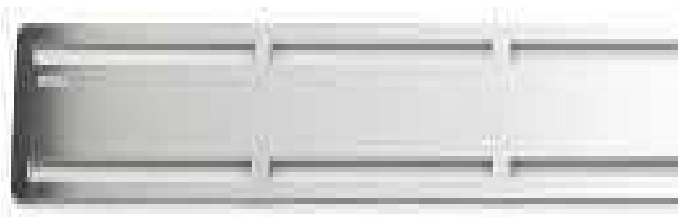

Specifications

ITEM NUMBER 1606.0700	LENGTH MODEL 700 mm	WEIGHT INCLUDING PACKAGING 280 g
WEIGHT EXCLUDING PACKAGING 240 g	MATERIAL Stainless steel (AISI 304)	SURFACE Brushed

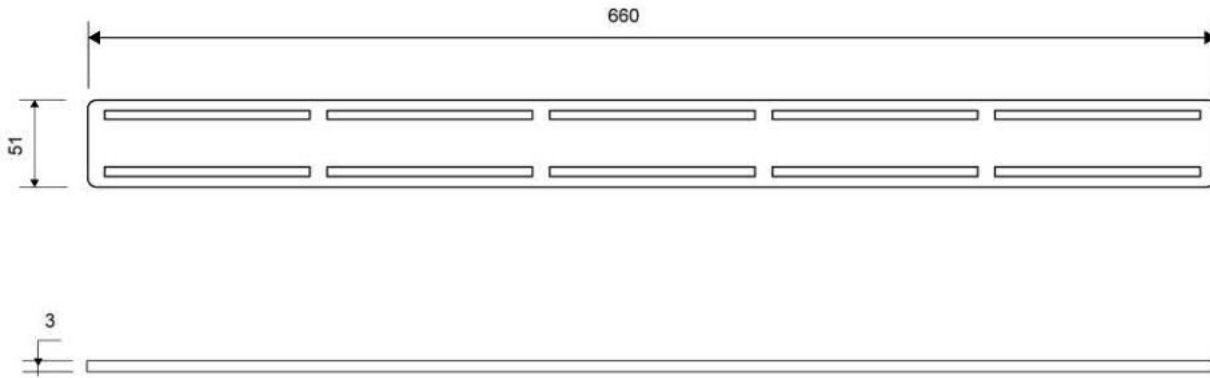

1606.0700

Products