

1004.1000K1 Standard Outlet DATA SHEET



KIT CONTAINS

WALL MOUNTED DRAIN
STANDARD OUTLET
CLASSICLINE FRAME
ANNIVERSARIO GRATE

WM | Wetroom Materials

www.wetroommaterials.com sales@wetroommaterials.com

UK: Derwentside, 25 Town Street, Duffield, Belper, Derbyshire, DE56 4EH T: +44 (0) 1332 840 820
IRE: Unit E1 Ballymount Industrial Estate, Walkinstown, Dublin 12, D12 WR60 T: +353 (0) 1 297 3488

1004.1001 - 1000 Model Drain Body

Line 1004

Wall Mounted Linear Drain fixed to wall for a very secure installation and to allow for a one way fall. Suitable for 25mm wall build up. For larger sizes, please contact Wet Room Materials. Can be freely positioned against rear wall, independent of any side walls.



Specifications

| | | |
|---------------------------|--------------------------------|-----------------------------------|
| ITEM NUMBER | GTIN NUMBER | MATERIAL |
| 1004.1001 | 5707692008417 | 1.5 mm stainless steel (AISI 304) |
| USAGE | SURFACE | MEMBRANE |
| Linear drain | Pickled | Liquid or sheet membrane |
| FLOOR CONSTRUCTION | FLOORING | MOUNTING |
| All | Tiles | 6 mm Pluks 6 mm Skruer. Torx 20 |
| CENTER | INSTALLATION LENGTH (L) | HEIGHT (H) |
| 556 mm | 1112 mm | 20 mm |
| LENGTH MODEL | | |
| 1000 | | |

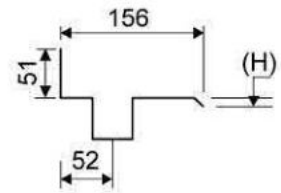
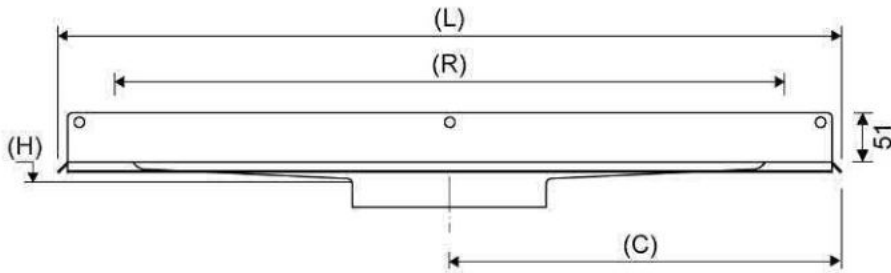
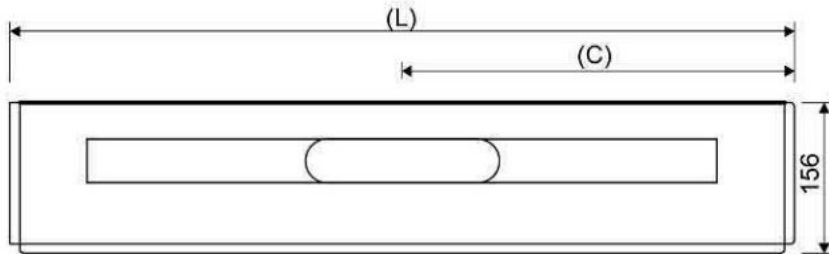

1416.0050 - Multi Directional Outlet

Line 1416.0050

Ø 50 mm horizontal drain

Can be rotated 180 degrees if a rear-facing outlet is required.

Note two drains. Cannot be used as an inlet.



Specifications

| | | |
|----------------------------|---------------|--|
| ITEM NUMBER | GTIN NUMBER | WEIGHT INCLUDING PACKAGING |
| 1416.0050 | 5707692012520 | 505 g |
| WEIGHT EXCLUDING PACKAGING | MATERIAL | USAGE |
| 312 g | Plastic (PP) | Line drain |
| BARRIER | GASKET | CAPACITY |
| With | EPDM | 0,8 l/s |
| SIDE INLET | CENTER | FITS DRAIN UNIT |
| Without | 32 mm | 1001, 1002, 1003, 1004, 1100, 3002, 3004, 5002, 5003, 4004 |

FITTING HEIGHTS - LINE FAUCETS 1001, 1002, 1003, 1004

| Ø | Outlet direction | 300 | 600 | 700 | 800 | 900 | 1000 | 1200 |
|---------|------------------|-------|--------|--------|--------|--------|--------|--------|
| Ø 50 mm | Horizontal | 98 mm | 102 mm | 103 mm | 104 mm | 105 mm | 106 mm | 108 mm |

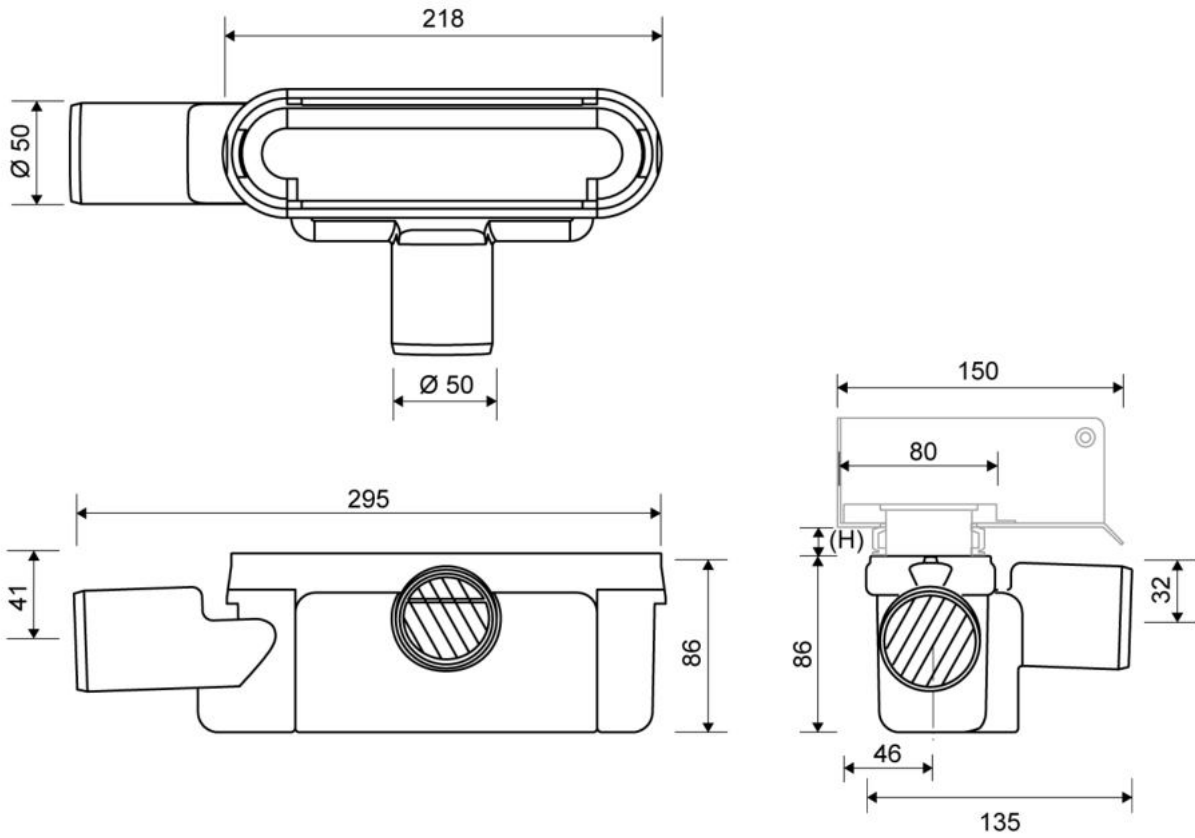

WM | Wetroom Materials

www.wetroommaterials.com sales@wetroommaterials.com

UK: Derwentside, 25 Town Street, Duffield, Belper, Derbyshire, DE56 4EH T: +44 (0) 1332 840 820
IRE: Unit E1 Ballymount Industrial Estate, Walkinstown, Dublin 12, D12 WR60 T: +353 (0) 1 297 3488

1500.1012 - Classic Line Frame

Line 1500

Brushed Stainless Steel Classicline Frame to be used with all Classicline grates. Also available with as 8 and 10mm frame heights (depending on thickness of floor tile)



Specifications

| | | |
|-----------------------------------|--|-----------------------------------|
| ITEM NUMBER | GTIN NUMBER | WEIGHT INCLUDING PACKAGING |
| 1500.1012 | 5707692003351 | 1230 g |
| WEIGHT EXCLUDING PACKAGING | MATERIAL | USAGE |
| 1000 g | Stainless steel (AISI 304) | Line drain |
| SURFACE | INSTALLATION LENGTH (L) | HEIGHT (H) |
| Brushed | 995 mm | H 12 mm |
| LENGTH MODEL | FITS DRAIN UNIT | INSERT |
| 1000 mm | 1001, 1002, 1003, 1004, 1100, 5002, 5003 | Synthetic |

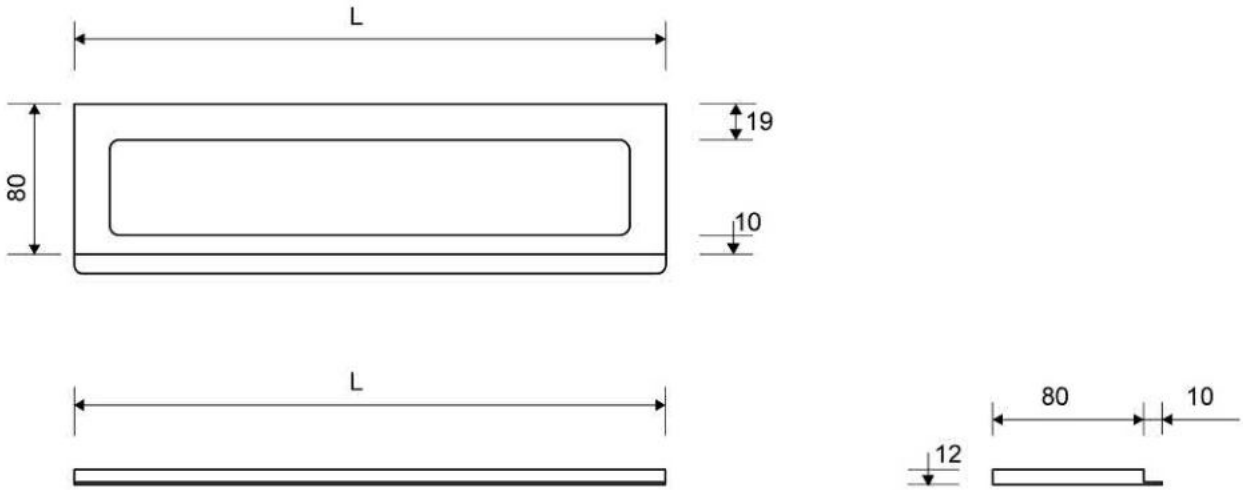

1606.1000 - 1000mm Anniversario Grate

Line 1600

Brushed Stainless Steel grate to be placed onto Classicline Frame

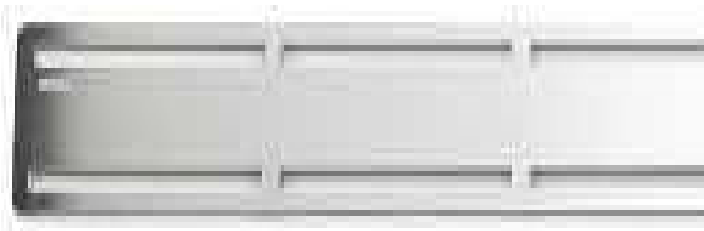

Specifications

| | | |
|-----------------------------------|----------------------------|-----------------------------------|
| ITEM NUMBER | LENGTH MODEL | WEIGHT INCLUDING PACKAGING |
| 1606.1000 | 1000 mm | 280 g |
| WEIGHT EXCLUDING PACKAGING | MATERIAL | SURFACE |
| 240 g | Stainless steel (AISI 304) | Brushed |

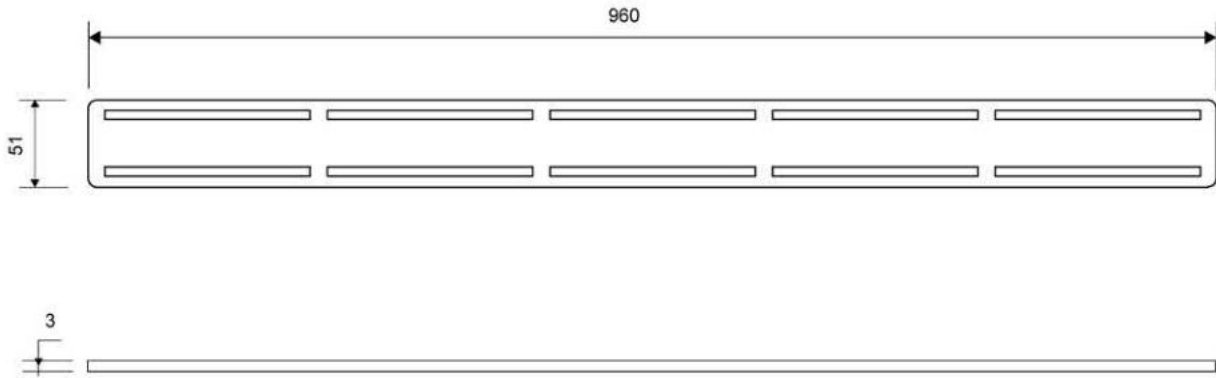

1606.1000

Products