



KIT CONTAINS

FREESTANDING DRAIN
INSTALLATION FEET
MULTI DIRECTIONAL OUTLET
CLASSICLINE FRAME
ANNIVERSARIO GRATE

WM | Wetroom Materials

www.wetroommaterials.com sales@wetroommaterials.com

UK: Derwentside, 25 Town Street, Duffield, Belper, Derbyshire, DE56 4EH T: +44 (0) 1332 840 820
IRE: Unit E1 Ballymount Industrial Estate, Walkinstown, Dublin 12, D12 WR60 T: +353 (0) 1 297 3488

3004.0800 - 800 Model Drain Body

Line 3004

For shower cubicle with no permanent walls



Specifications

ITEM NUMBER	GTIN NUMBER	WEIGHT INCLUDING PACKAGING
3004.0800	5707692007076	4100 g
WEIGHT EXCLUDING PACKAGING	MATERIAL	USAGE
3900 g	1,5 mm stainless steel (AISI 304)	Line drain
SURFACE	MEMBRANE	FLOOR CONSTRUCTION
Pickled	Liquid or sheet membrane	All
FLOORING	MOUNTING	CENTER
Tiles	6 mm plugs 6 mm screws. Torx 20	456 mm
INSTALLATION LENGTH (L)	HEIGHT (H)	LENGTH MODEL
912 mm	18 mm	800 mm

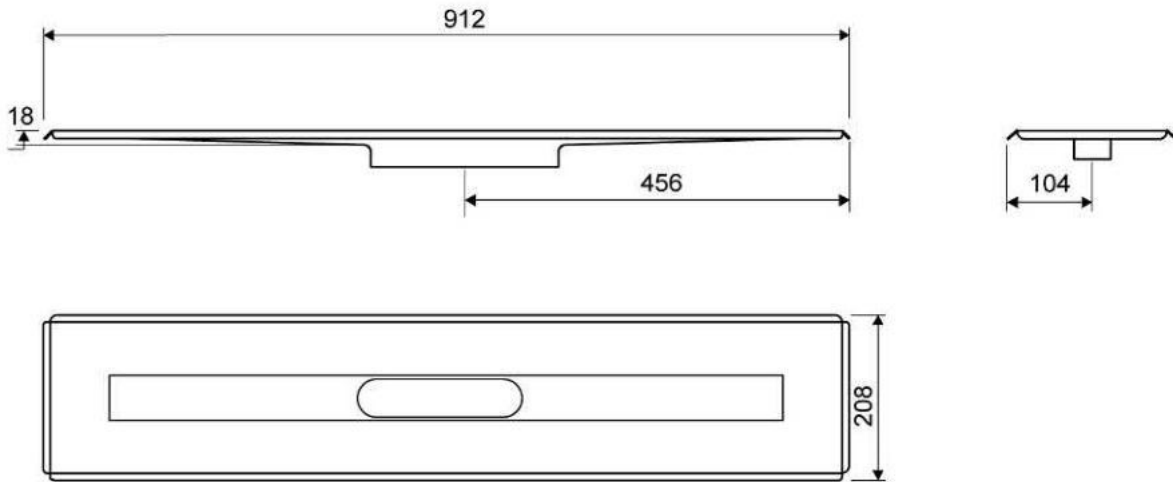

3004.0800

Height Adjustable Installation Feet

Height-adjustable feet (120-220 mm) for installation in concrete.
included with 3004 Unidrain.

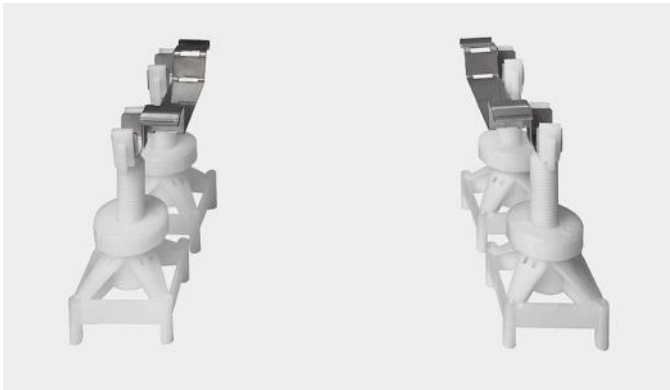

1416.0050 - Multi Directional Outlet

Line 1416.0050

Ø 50 mm horizontal drain

Can be rotated 180 degrees if a rear-facing outlet is required.

Note two drains. Cannot be used as an inlet.



Specifications

ITEM NUMBER	GTIN NUMBER	WEIGHT INCLUDING PACKAGING
1416.0050	5707692012520	505 g
WEIGHT EXCLUDING PACKAGING	MATERIAL	USAGE
312 g	Plastic (PP)	Line drain
BARRIER	GASKET	CAPACITY
With	EPDM	0,8 l/s
SIDE INLET	CENTER	FITS DRAIN UNIT
Without	32 mm	1001, 1002, 1003, 1004, 1100, 3002, 3004, 5002, 5003, 4004

FITTING HEIGHTS - LINE FAUCETS 1001, 1002, 1003, 1004

Ø	Outlet direction	300	600	700	800	900	1000	1200
Ø 50 mm	Horizontal	98 mm	102 mm	103 mm	104 mm	105 mm	106 mm	108 mm

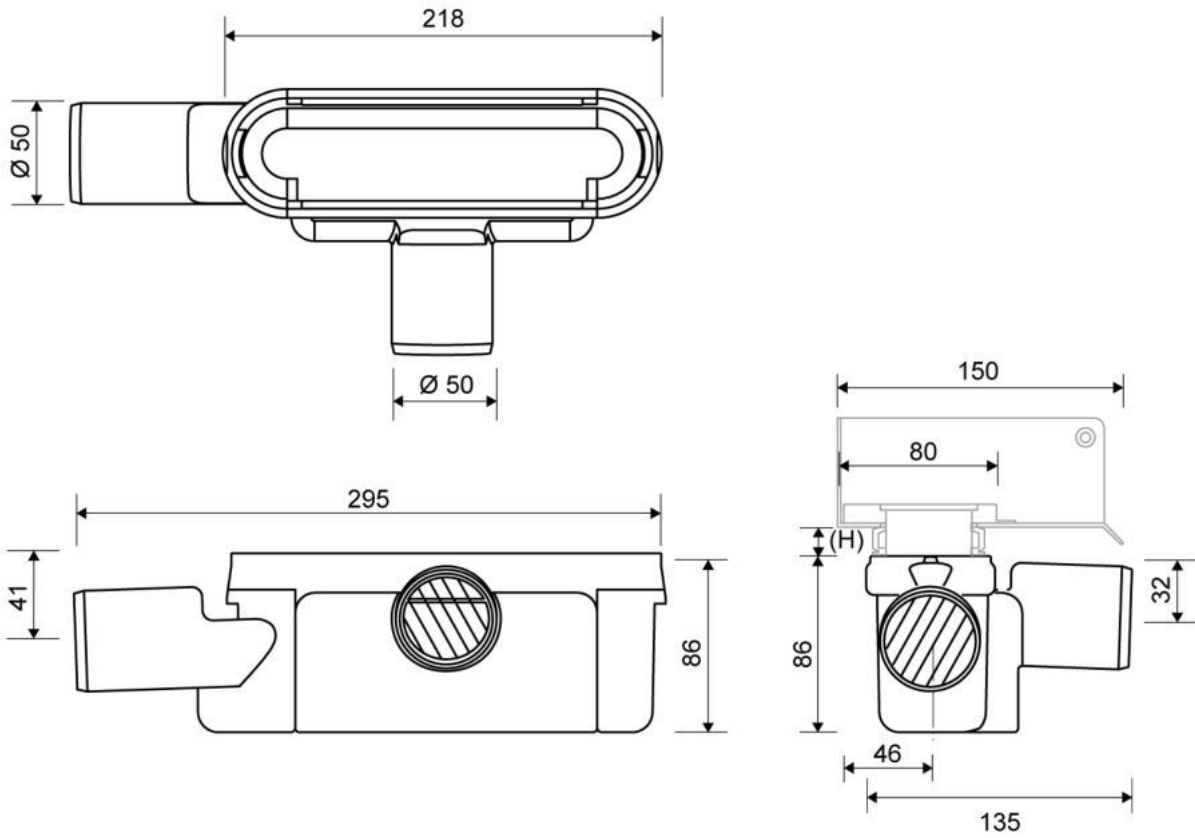

WM | Wetroom Materials

www.wetroommaterials.com sales@wetroommaterials.com

UK: Derwentside, 25 Town Street, Duffield, Belper, Derbyshire, DE56 4EH T: +44 (0) 1332 840 820
IRE: Unit E1 Ballymount Industrial Estate, Walkinstown, Dublin 12, D12 WR60 T: +353 (0) 1 297 3488

3500.0812- Standard Outlet

Line 3500 | ClassicLine

Available in 8, 10 and 12 mm heights (depending on the thickness of the floor tile)



Specifications

ITEM NUMBER	GTIN NUMBER	WEIGHT INCLUDING PACKAGING
3500.0812	5707692008820	720 g
WEIGHT EXCLUDING PACKAGING	MATERIAL	USAGE
700 g	Stainless steel (AISI 304)	Line drain
SURFACE	INSTALLATION LENGTH (L)	HEIGHT (H)
Brushed	795 mm	H 12 mm
LENGTH MODEL	FITS DRAIN UNIT	INSERT
800 mm	3004	Synthetic

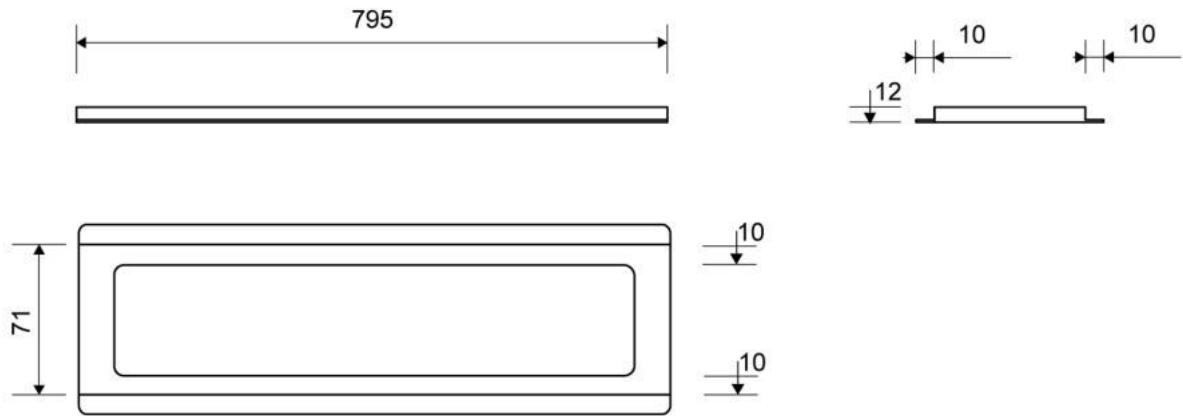

3500.0812

Products

1606.0800 - 800mm Anniversario Grate

Line 1600

Brushed Stainless Steel grate to be placed onto Classicline Frame

Contact Wet Room Materials for other grate options

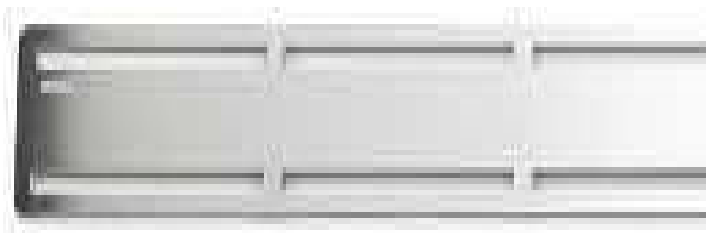

Other grates available

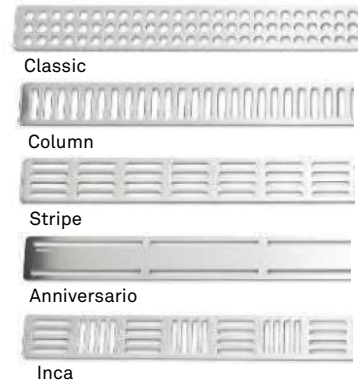

Specifications

ITEM NUMBER	GTIN NUMBER	WEIGHT INCLUDING PACKAGING
1604.0800	5707692001197	730 g
WEIGHT EXCLUDING PACKAGING	MATERIAL	USAGE
700 g	Stainless steel (AISI 304)	Line drain
SURFACE	LENGTH MODEL	DIMENSIONS
Brushed	800 mm	3 mm solid3 mm solid3 mm solid3 mm solid3 mm solid3 mm solid

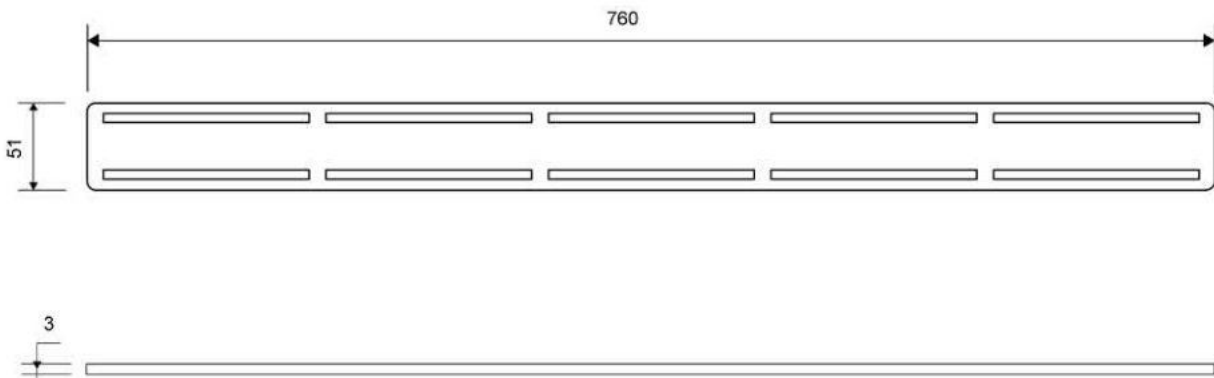

1606.0800

Products