

1004.0300K3 Standard Outlet  
DATA SHEET



**KIT CONTAINS**

WALL MOUNTED DRAIN  
MULTI DIRECTIONAL OUTLET  
HIGHLINE FRAME  
HIGHLINE PANEL

## 1004.0301 - 300 Model Drain Body

Line 1004

Wall Mounted Linear Drain fixed to wall for a very secure installation and to allow for a one way fall.  
Suitable for 25mm wall build up. For larger sizes, please contact Wet Room Materials.  
Can be freely positioned against rear wall, independent of any side walls.



### Specifications

<b>ITEM NUMBER</b>	<b>GTIN NUMBER</b>	<b>MATERIAL</b>
1004.0301	5707692008493	1.5 mm stainless steel (AISI 304)
<b>USAGE</b>	<b>SURFACE</b>	<b>MEMBRANE</b>
Linear drain	Pickled	Liquid or sheet membrane
<b>FLOOR CONSTRUCTION</b>	<b>FLOORING</b>	<b>MOUNTING</b>
All	Tiles	6 mm Pluks 6 mm Skruer. Torx 20
<b>CENTER</b>	<b>INSTALLATION LENGTH (L)</b>	<b>HEIGHT (H)</b>
216 mm	432 mm	12 mm
<b>LENGTH MODEL</b>		
300		

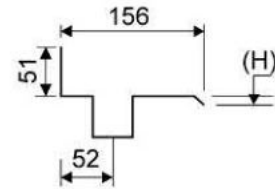
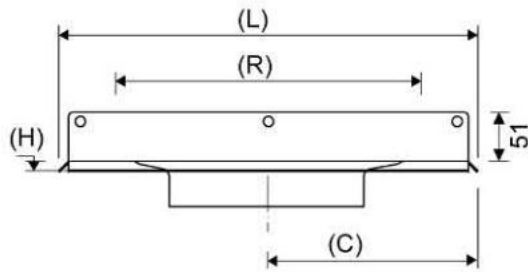
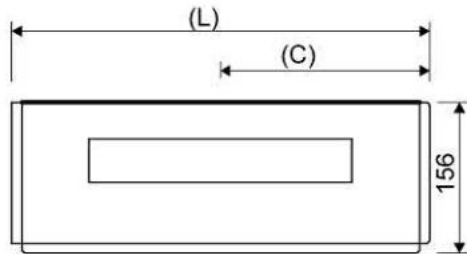

## 1416.0050 - Multi Directional Outlet

Line 1416.0050

Ø 50 mm horizontal drain

Can be rotated 180 degrees if a rear-facing outlet is required.

Note two drains. Cannot be used as an inlet.



### Specifications

ITEM NUMBER	GTIN NUMBER	WEIGHT INCLUDING PACKAGING
1416.0050	5707692012520	505 g
WEIGHT EXCLUDING PACKAGING	MATERIAL	USAGE
312 g	Plastic (PP)	Line drain
BARRIER	GASKET	CAPACITY
With	EPDM	0,8 l/s
SIDE INLET	CENTER	FITS DRAIN UNIT
Without	32 mm	1001, 1002, 1003, 1004, 1100, 3002, 3004, 5002, 5003, 4004

#### FITTING HEIGHTS - LINE FAUCETS 1001, 1002, 1003, 1004

Ø	Outlet direction	300	600	700	800	900	1000	1200
Ø 50 mm	Horizontal	98 mm	102 mm	103 mm	104 mm	105 mm	106 mm	108 mm

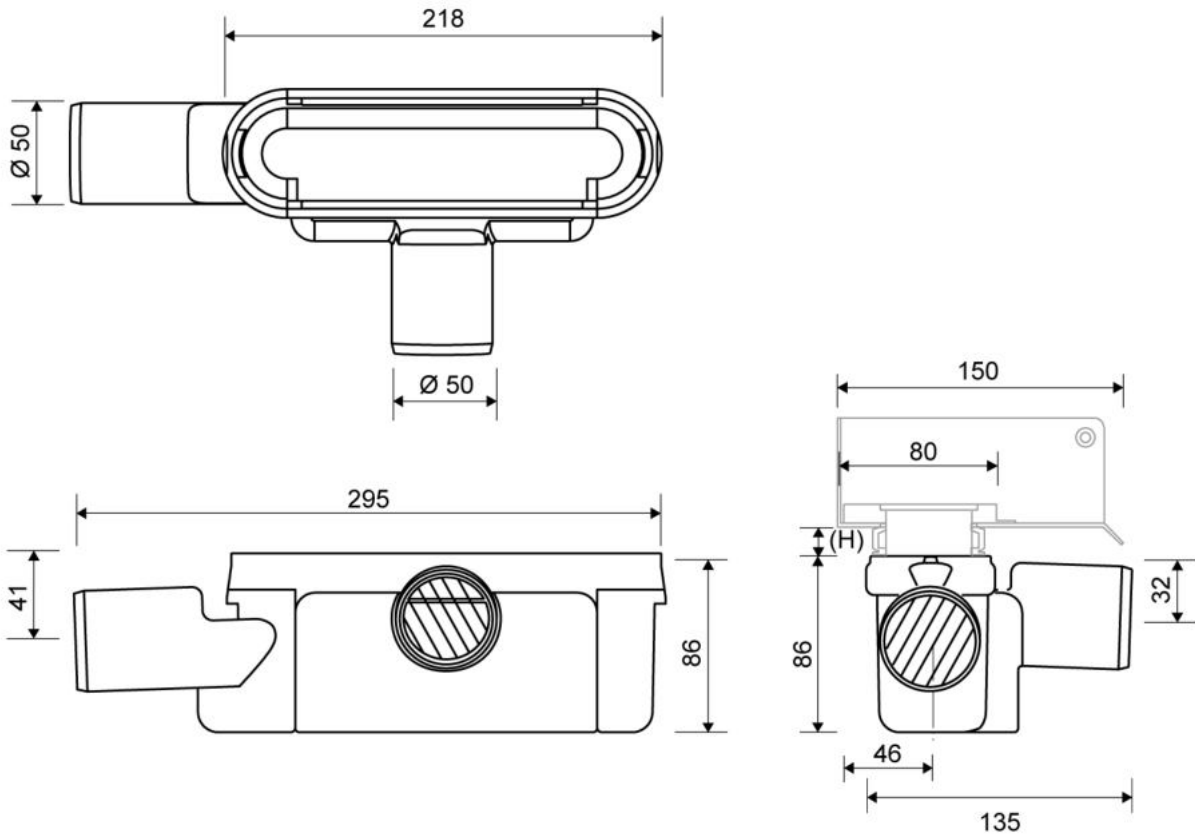

## 1910.0315 - 300mm Stainless Steel Frame

Line 1910

Highline Frame can be placed around Highline Custom, Cassette and Panel.  
Also available in 10, 12 and 25mm heights (depending on the thickness of the floor tile)  
Contact Wetroom Materials for other heights.

Must be installed before tiling.



### Specifications

ITEM NUMBER	GTIN NUMBER	WEIGHT INCLUDING PACKAGING
1910.0315	5707692004303	980 g
WEIGHT EXCLUDING PACKAGING	MATERIAL	USAGE
920 g	Stainless steel (AISI 304)	Line drain
SURFACE	INSTALLATION LENGTH (L)	HEIGHT (H)
Brushed	315 mm	H 15 mm
LENGTH MODEL	FITS DRAIN UNIT	INSERT
300 mm	1004	Synthetic

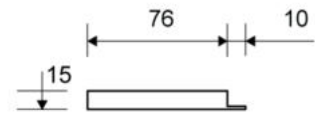
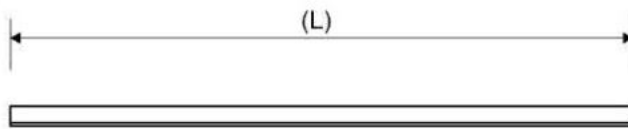
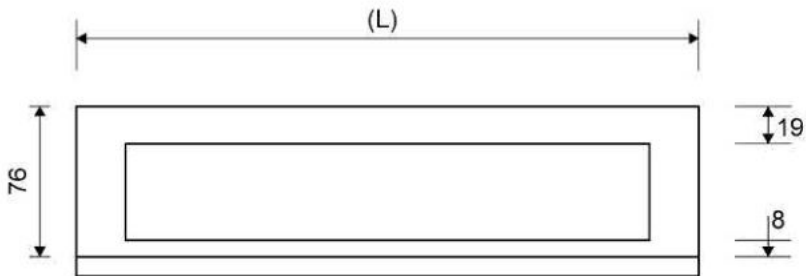

## 1920.0300 - 300mm Panel

### HighLine | Panel

The set consists of a Highline Panel in Brushed Stainless Steel, heightener set and screws.  
Can be used with or without Highline Frame.

When using without Highline Frame, ensure rear wall build up allows for equal drainage gap on all sides.  
Also available in Black, Brass, Copper and Polished Stainless Steel



### Specifications

ITEM NUMBER	GTIN NUMBER	WEIGHT INCLUDING PACKAGING
1920.0300	5707692004488	820 g
WEIGHT EXCLUDING PACKAGING	MATERIAL	USAGE
770 g	Stainless steel (AISI 304)	Line drain
SURFACE	LENGTH MODEL	HEIGHTENER SET
Brushed	300 mm	Plastic (PE)
LENGTH WITH/WITHOUT FRAME		
253/315 mm		



