

1004.1800K3 Standard Outlet DATA SHEET



KIT CONTAINS

WALL MOUNTED DRAIN
MULTI DIRECTIONAL OUTLET
HIGHLINE FRAME
HIGHLINE PANEL

1004.1801 - 1800 Model Drain Body

Line 1004

Wall Mounted Linear Drain fixed to wall for a very secure installation and to allow for a one way fall.
Suitable for 25mm wall build up. For larger sizes, please contact Wet Room Materials.
Can be freely positioned against rear wall, independent of any side walls.



Specifications

ITEM NUMBER	GTIN NUMBER	MATERIAL
1004.1801	5707692008387	1.5 mm stainless steel (AISI 304)
USAGE	SURFACE	MEMBRANE
Linear drain	Pickled	Liquid or sheet membrane
FLOOR CONSTRUCTION	FLOORING	MOUNTING
All	Tiles	6 mm Pluks 6 mm Skruer. Torx 20
CENTER	INSTALLATION LENGTH (L)	HEIGHT (H)
506 mm	1909 mm	19 mm
LENGTH MODEL		
1800		

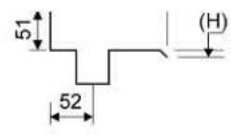
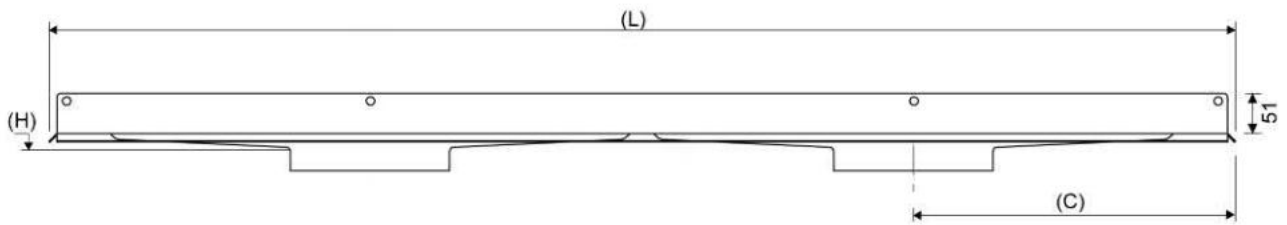
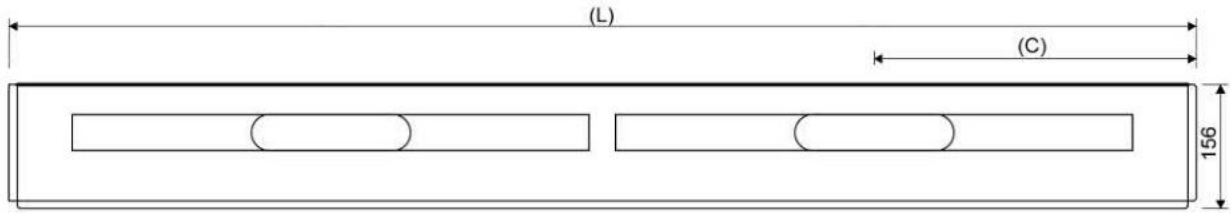

1416.0050 - Multi Directional Outlet

Line 1416.0050

Ø 50 mm horizontal drain

Can be rotated 180 degrees if a rear-facing outlet is required.

Note two drains. Cannot be used as an inlet.



Specifications

ITEM NUMBER	GTIN NUMBER	WEIGHT INCLUDING PACKAGING
1416.0050	5707692012520	505 g
WEIGHT EXCLUDING PACKAGING	MATERIAL	USAGE
312 g	Plastic (PP)	Line drain
BARRIER	GASKET	CAPACITY
With	EPDM	0,8 l/s
SIDE INLET	CENTER	FITS DRAIN UNIT
Without	32 mm	1001, 1002, 1003, 1004, 1100, 3002, 3004, 5002, 5003, 4004

FITTING HEIGHTS - LINE FAUCETS 1001, 1002, 1003, 1004

Ø	Outlet direction	300	600	700	800	900	1000	1200
Ø 50 mm	Horizontal	98 mm	102 mm	103 mm	104 mm	105 mm	106 mm	108 mm

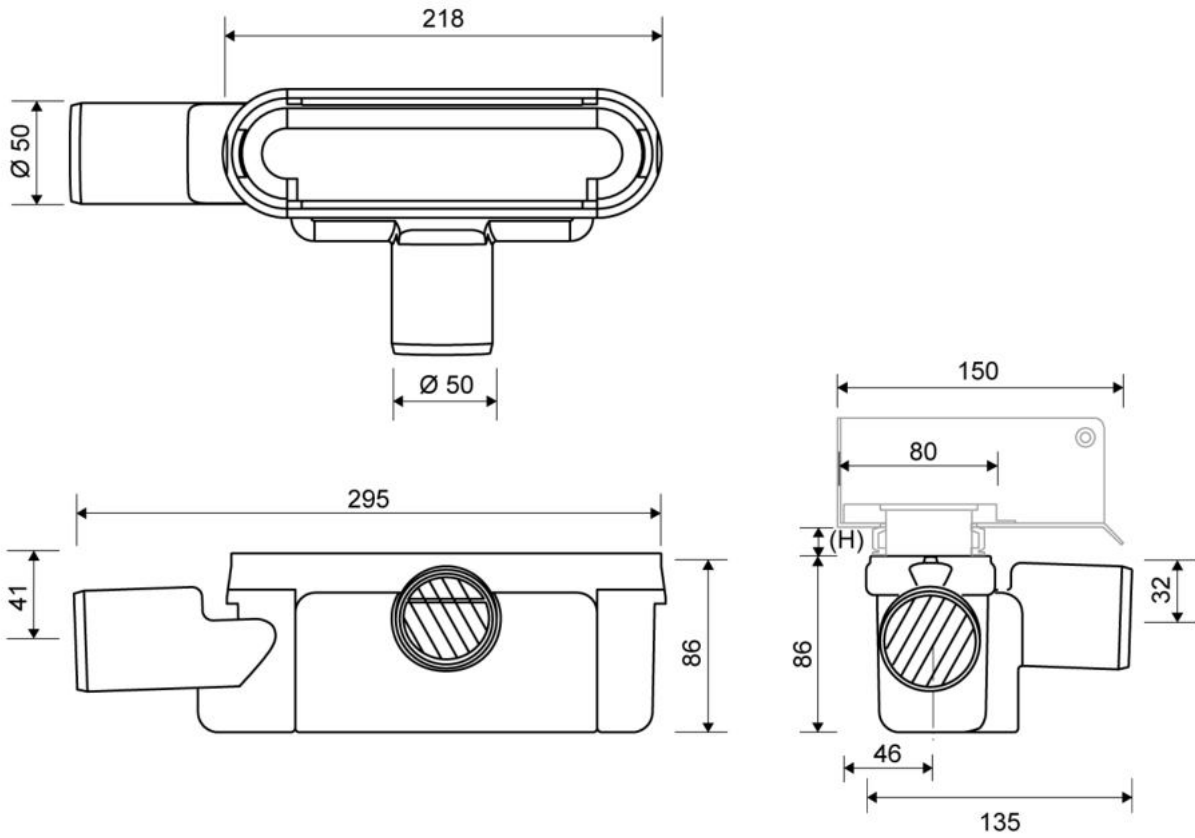

1910.0915 - 900mm Stainless Steel Frame

Line 1910

Highline Frame can be placed around Highline Custom, Cassette and Panel.
Also available in 10, 12 and 25mm heights (depending on the thickness of the floor tile)
Contact Wetroom Materials for other heights.

Must be installed before tiling.



Specifications

ITEM NUMBER	GTIN NUMBER	WEIGHT INCLUDING PACKAGING
1910.0915	5707692004396	2380 g
WEIGHT EXCLUDING PACKAGING	MATERIAL	USAGE
2270 g	Stainless steel (AISI 304)	Line drain
SURFACE	INSTALLATION LENGTH (L)	HEIGHT (H)
Brushed	895 mm	H 12 mm
LENGTH MODEL	FITS DRAIN UNIT	INSERT
900 mm	1001, 1002, 1003, 1004, 1100, 5002, 5003	Synthetic

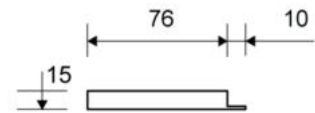
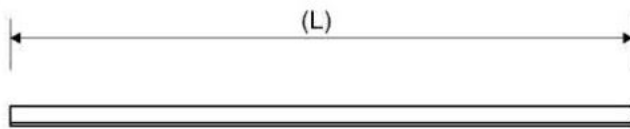
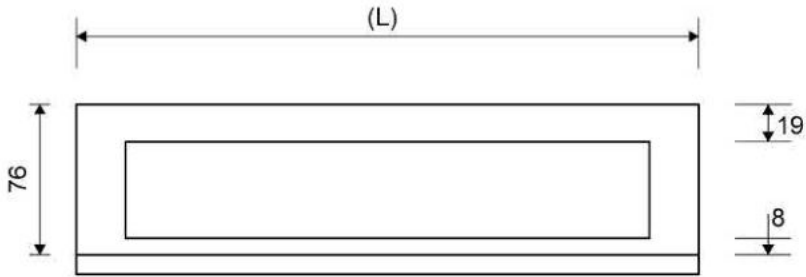

1920.0900 - 900mm Panel

HighLine | Panel

The set consists of a Highline Panel in Brushed Stainless Steel, heightener set and screws.
Can be used with or without Highline Frame.

When using without Highline Frame, ensure rear wall build up allows for equal drainage gap on all sides.
Also available in Black, Brass, Copper and Polished Stainless Steel



Specifications

ITEM NUMBER	GTIN NUMBER	WEIGHT INCLUDING PACKAGING
1920.0900	5707692004518	2900 g
MATERIAL	USAGE	SURFACE
Stainless steel (AISI 304)	Line drain	Brushed
LENGTH MODEL	HEIGHTENER SET	LENGTH WITH/WITHOUT FRAME
900 mm	Plastic (PE)	833/895 mm

