

3004.0800K3 Standard Outlet DATA SHEET



KIT CONTAINS

FREESTANDING DRAIN
INSTALLATION FEET
MULTI DIRECTIONAL OUTLET
HIGHLINE FRAME
HIGHLINE PANEL BRUSHED
STAINLESS STEEL

3004.0800 - 800 Model Drain Body

Line 3004

For shower cubicle with no permanent walls



Specifications

ITEM NUMBER	GTIN NUMBER	WEIGHT INCLUDING PACKAGING
3004.0800	5707692007076	4100 g
WEIGHT EXCLUDING PACKAGING	MATERIAL	USAGE
3900 g	1,5 mm stainless steel (AISI 304)	Line drain
SURFACE	MEMBRANE	FLOOR CONSTRUCTION
Pickled	Liquid or sheet membrane	All
FLOORING	MOUNTING	CENTER
Tiles	6 mm plugs 6 mm screws. Torx 20	456 mm
INSTALLATION LENGTH (L)	HEIGHT (H)	LENGTH MODEL
912 mm	18 mm	800 mm

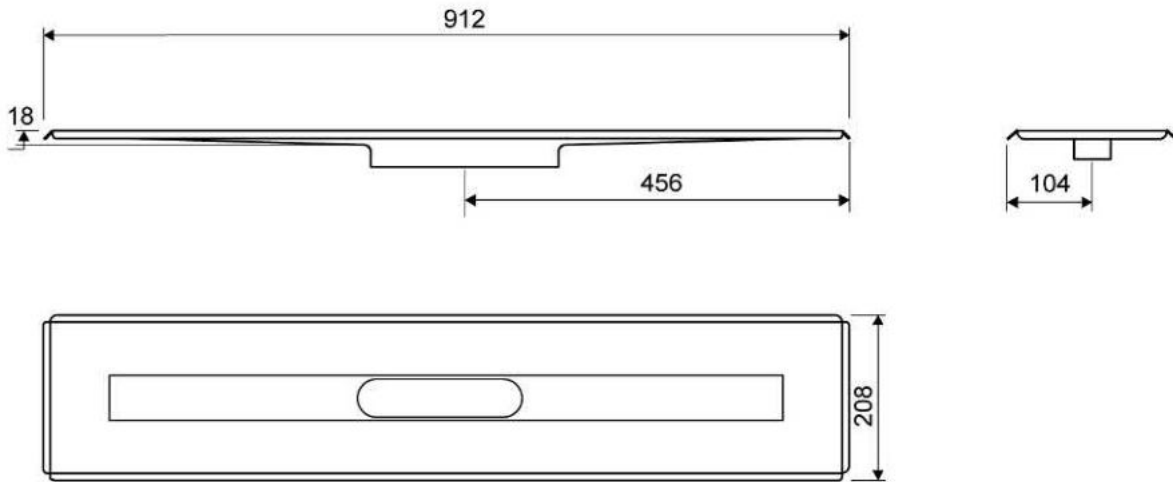

3004.0800

Height Adjustable Installation Feet

Height-adjustable feet (120-220 mm) for installation in concrete.
included with 3004 Unidrain.



1416.0050 - Multi Directional Outlet

Line 1416.0050

Ø 50 mm horizontal drain

Can be rotated 180 degrees if a rear-facing outlet is required.

Note two drains. Cannot be used as an inlet.



Specifications

ITEM NUMBER	GTIN NUMBER	WEIGHT INCLUDING PACKAGING
1416.0050	5707692012520	505 g
WEIGHT EXCLUDING PACKAGING	MATERIAL	USAGE
312 g	Plastic (PP)	Line drain
BARRIER	GASKET	CAPACITY
With	EPDM	0,8 l/s
SIDE INLET	CENTER	FITS DRAIN UNIT
Without	32 mm	1001, 1002, 1003, 1004, 1100, 3002, 3004, 5002, 5003, 4004

FITTING HEIGHTS - LINE FAUCETS 1001, 1002, 1003, 1004

Ø	Outlet direction	300	600	700	800	900	1000	1200
Ø 50 mm	Horizontal	98 mm	102 mm	103 mm	104 mm	105 mm	106 mm	108 mm

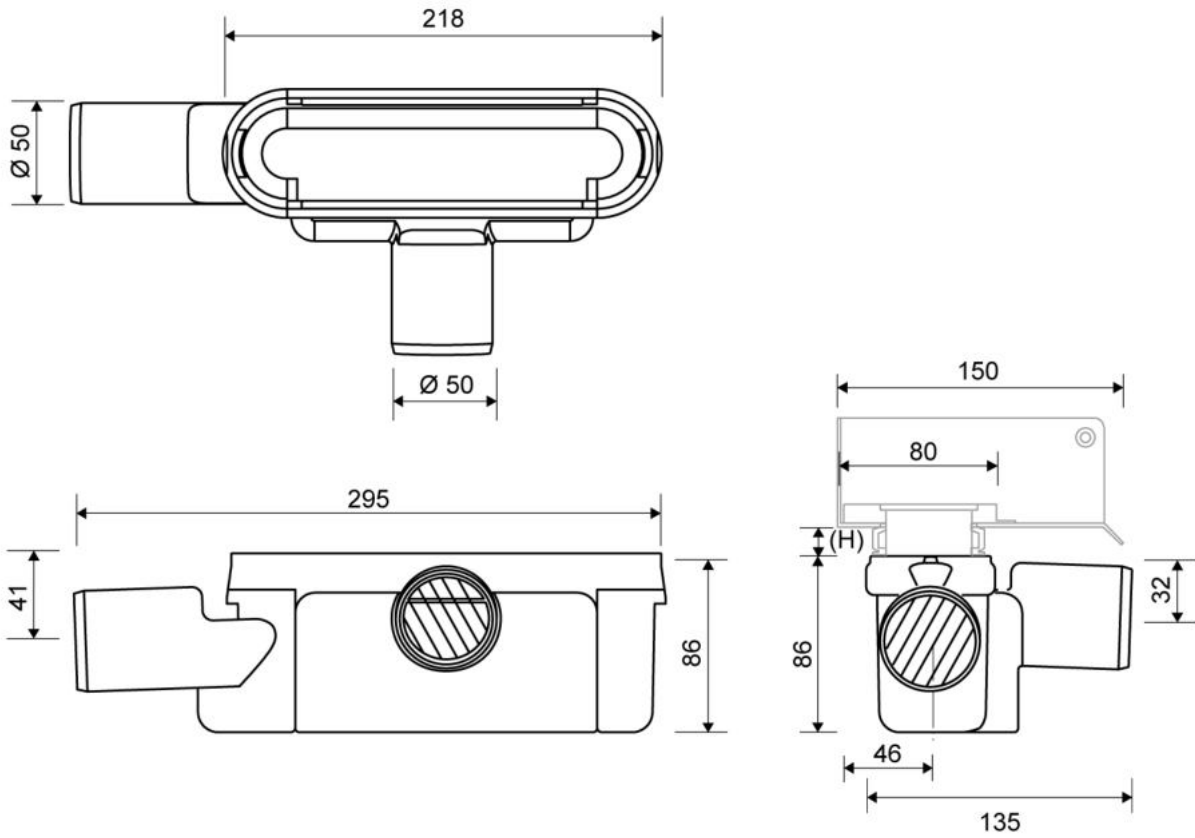

3910.0815 - 800mm Frame

Line 3910 | HighLine

Frame available in 10, 12, 15 and 25 mm heights (depending on the thickness of the floor tile)
 Exclusive design with top in solid 4 mm stainless steel. Insert ensures a snug fit inside the drain unit

Must be used with HighLine PANEL, Cassette or CUSTOM



Specifications

ITEM NUMBER	GTIN NUMBER	MATERIAL
3910.0815	5707692008912	Stainless steel (AISI 304)
USAGE	SURFACE	INSTALLATION LENGTH (L)
Line drain	Brushed	795 mm
HEIGHT (H)	LENGTH MODEL	FITS DRAIN UNIT
H 15 mm	800 mm	3004
INSERT		
Synthetic		

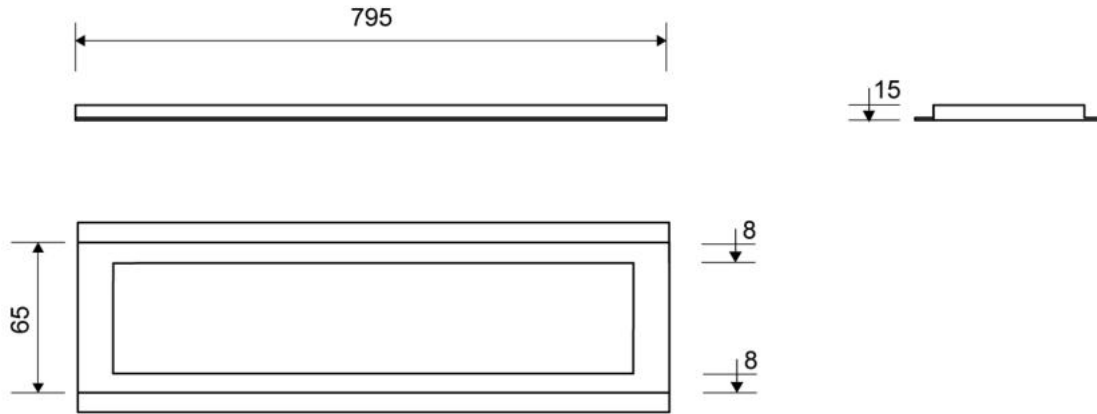

3910.0815

Products

1920.0800 - 800 Highline Panel

HighLine | Panel

The set consists of a Highline Panel in Brushed Stainless Steel, heightener set and screws.
Can be used with or without Highline Frame.

When using without Highline Frame, ensure rear wall build up allows for equal drainage gap on all sides.
Also available in Black, Brass, Copper and Polished Stainless Steel



Specifications

ITEM NUMBER	GTIN NUMBER	WEIGHT INCLUDING PACKAGING
1920.0800	5707692004501	2300 g
WEIGHT EXCLUDING PACKAGING	MATERIAL	USAGE
2230 g	Stainless steel (AISI 304)/safety float glass	Line drain
SURFACE	LENGTH MODEL	HEIGHTENER SET
Brushed/frosted	800 mm	Plastic (PE)
LENGTH WITH/WITHOUT FRAME		
733/795 mm		

