

# 3004.1000K5NF Standard Outlet DATA SHEET

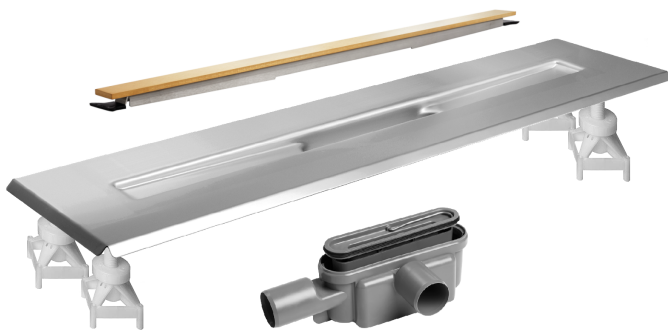

## KIT CONTAINS

FREESTANDING DRAIN  
INSTALLATION FEET  
MULTI DIRECTIONAL OUTLET  
HIGHLINE PANEL BRASS



## 3004.1000 - 1000 Model Drain Body

Line 3004

For shower cubicle with no permanent walls



### Specifications

ITEM NUMBER	GTIN NUMBER	WEIGHT INCLUDING PACKAGING
3004.1000	5707692007083	4300 g
WEIGHT EXCLUDING PACKAGING	MATERIAL	USAGE
4100 g	1,5 mm stainless steel (AISI 304)	Line drain
SURFACE	MEMBRANE	FLOOR CONSTRUCTION
Pickled	Liquid or sheet membrane	All
FLOORING	MOUNTING	CENTER
Tiles	6 mm plugs 6 mm screws. Torx 20	556 mm
INSTALLATION LENGTH (L)	HEIGHT (H)	LENGTH MODEL
1112 mm	20 mm	1000 mm

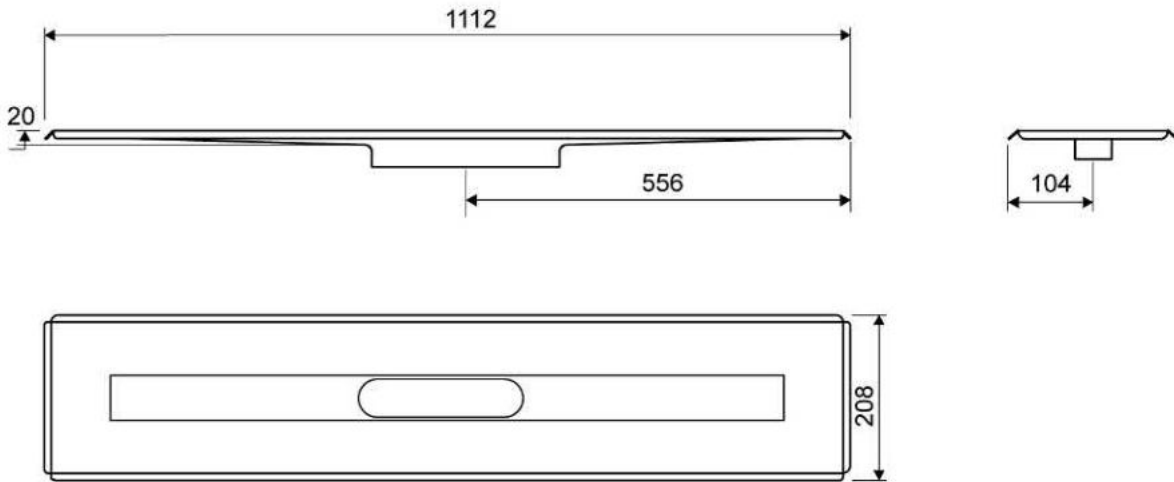

**3004.1000**

## Height Adjustable Installation Feet

Height-adjustable feet (120-220 mm) for installation in concrete.  
included with 3004 Unidrain.

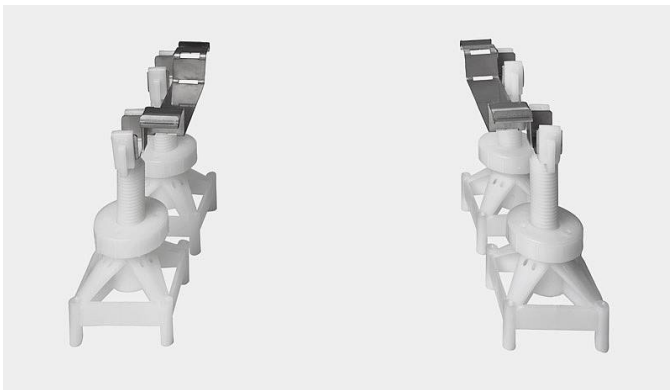



## 1416.0050 - Multi Directional Outlet

Line 1416.0050

Ø 50 mm horizontal drain

Can be rotated 180 degrees if a rear-facing outlet is required.

Note two drains. Cannot be used as an inlet.



### Specifications

ITEM NUMBER	GTIN NUMBER	WEIGHT INCLUDING PACKAGING
1416.0050	5707692012520	505 g
WEIGHT EXCLUDING PACKAGING	MATERIAL	USAGE
312 g	Plastic (PP)	Line drain
BARRIER	GASKET	CAPACITY
With	EPDM	0,8 l/s
SIDE INLET	CENTER	FITS DRAIN UNIT
Without	32 mm	1001, 1002, 1003, 1004, 1100, 3002, 3004, 5002, 5003, 4004

#### FITTING HEIGHTS - LINE FAUCETS 1001, 1002, 1003, 1004

Ø	Outlet direction	300	600	700	800	900	1000	1200
Ø 50 mm	Horizontal	98 mm	102 mm	103 mm	104 mm	105 mm	106 mm	108 mm

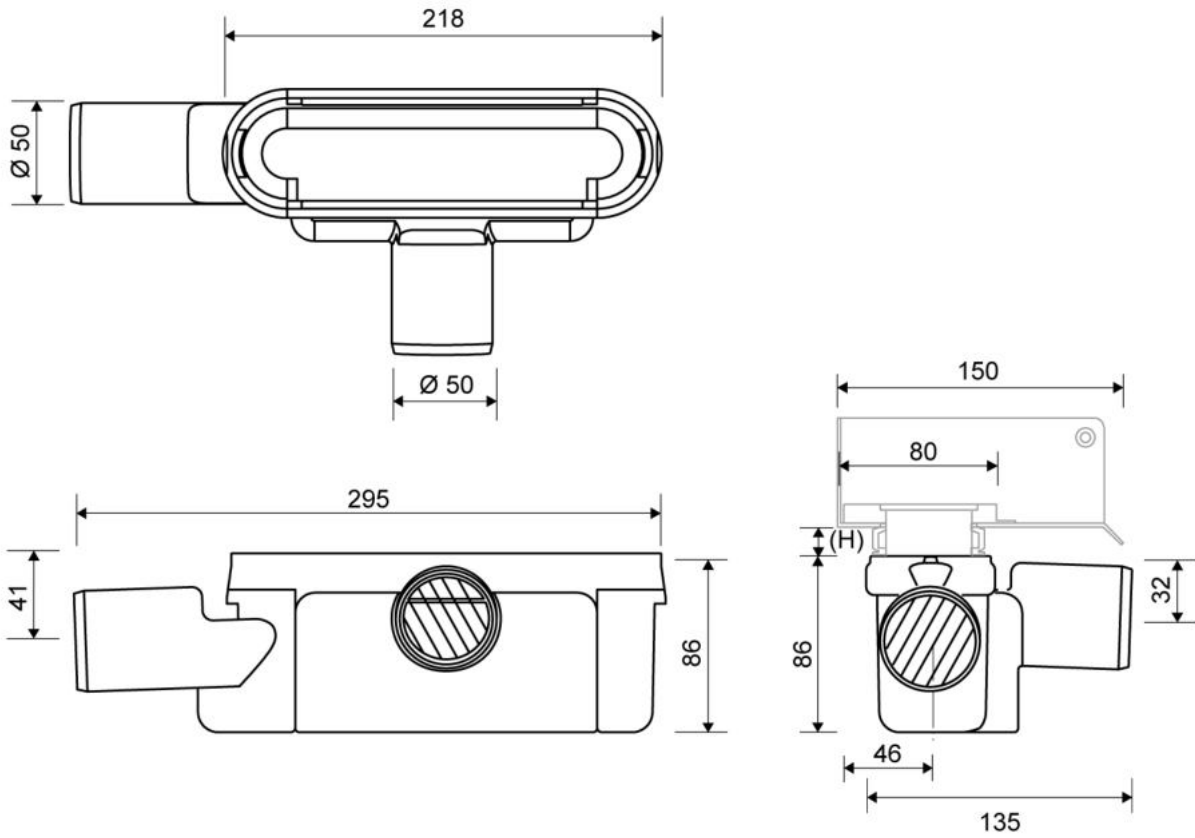

## 1920.1015 - 1000mm Brass Panel

HighLine Colour Panel | Brass

The set consists of a Highline Panel in Brushed Stainless Steel PVD coated Brass, heightener set and screws. Can be used with or without Highline Frame. Brass frame not available for Freestanding drain. When using without Highline Frame, ensure rear wall build up allows for equal drainage gap on all sides. Also available in Black, Copper, Brushed and Polished Stainless Steel



### Specifications

<b>ITEM NUMBER</b>	<b>GTIN NUMBER</b>	<b>MATERIAL</b>
1920.1015	5707692011653	Stainless steel (AISI 304)
<b>USAGE</b>	<b>SURFACE</b>	<b>LENGTH MODEL</b>
Linear drain	PVD Brass	1000 mm
<b>FITS DRAIN UNIT</b>	<b>HEIGHTENER SET</b>	<b>LENGTH WITH/WITHOUT FRAME</b>
1001, 1002, 1003, 1004, 1100, 5002, 5003	Plastic (PE)	933/995 mm



