

1004.1600K6M01 Low Profile Outlet
DATA SHEET



KIT CONTAINS

WALL MOUNTED DRAIN
LOW PROFILE OUTLET
HIGHLINE FRAME
HIGHLINE PANEL

1004.1601 - 1600 Model Drain Body

Line 1004

Wall Mounted Linear Drain fixed to wall for a very secure installation and to allow for a one way fall.
Suitable for 25mm wall build up. For larger sizes, please contact Wet Room Materials.
Can be freely positioned against rear wall, independent of any side walls.



Specifications

ITEM NUMBER	GTIN NUMBER	MATERIAL
1004.1601	5707692008387	1.5 mm stainless steel (AISI 304)
USAGE	SURFACE	MEMBRANE
Linear drain	Pickled	Liquid or sheet membrane
FLOOR CONSTRUCTION	FLOORING	MOUNTING
All	Tiles	6 mm Pluks 6 mm Skruer. Torx 20
CENTER	INSTALLATION LENGTH (L)	HEIGHT (H)
456 mm	1709 mm	18 mm
LENGTH MODEL		
1600		

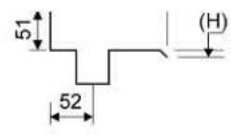
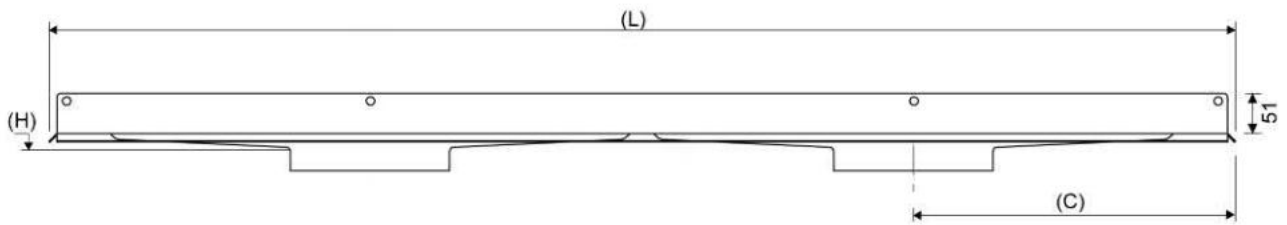
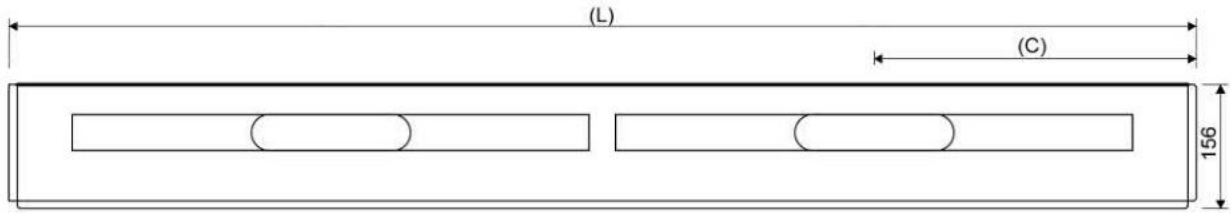

1417.0050 - Low Profile Outlet

Linear 1417.0050

Ø 50 mm horizontal drain

The odour barrier can be removed for cleaning

Can be rotated 180 degrees if a rear-facing outlet is required

Note: Odour barrier is VA-approved



Specifications

ITEM NUMBER	GTIN NUMBER	WEIGHT INCLUDING PACKAGING
1417.0050	5707692007915	500 g
WEIGHT EXCLUDING PACKAGING	MATERIAL	USAGE
350 g	Plastic (PP)	Line drain
BARRIER	GASKET	CAPACITY
With (odour barrier)	EPDM	0.6 l/s
SIDE INLET	CENTER	FITS DRAIN UNIT
Without	30 mm	1001, 1002, 1003, 1004, 1100, 3002, 3004, 5002, 5003, 4004

FITTING HEIGHTS - LINE FAUCETS 1001, 1002, 1003, 1004

Ø	Outlet direction	300	600	700	800	900	1000	1200
Ø 50 mm	Horizontal	64 mm	68 mm	69 mm	70 mm	71 mm	72 mm	74 mm

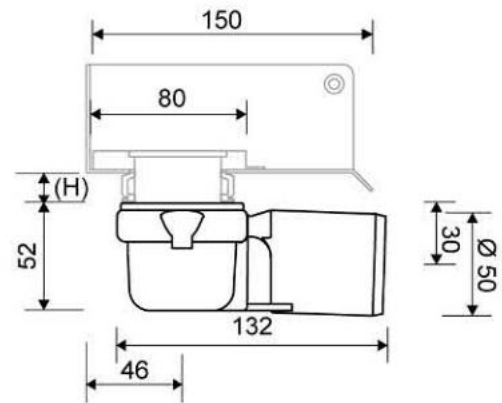
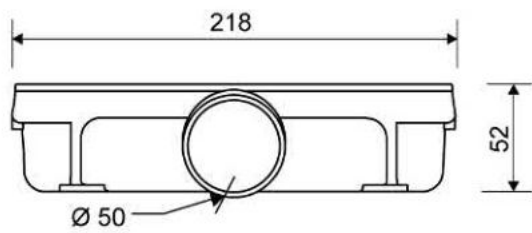
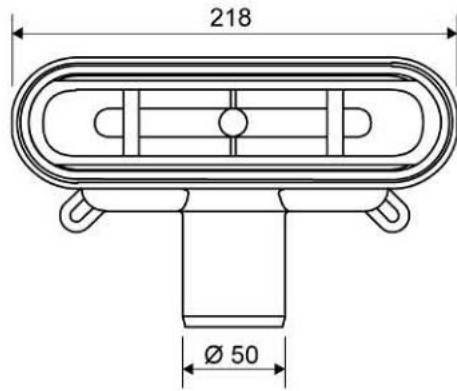

1916.0815- 800mm Highline frame

HighLine Colour frame | copper

Exclusive frame design with top in 4 mm solid PVD-treated stainless steel
Insert ensures a snug fit inside the drain unit.



Specifications

ITEM NUMBER 1916.0815	GTIN NUMBER 5707692012018	MATERIAL Stainless steel (AISI 304)
USAGE Linear drain	SURFACE PVD Copper	INSTALLATION LENGTH (L2) 795 mm
HEIGHT (H) H 15 mm	LENGTH MODEL 800 mm	FITS DRAIN UNIT 1001, 1002, 1003, 1004, 1100, 5002, 5003
INSERT Synthetic		

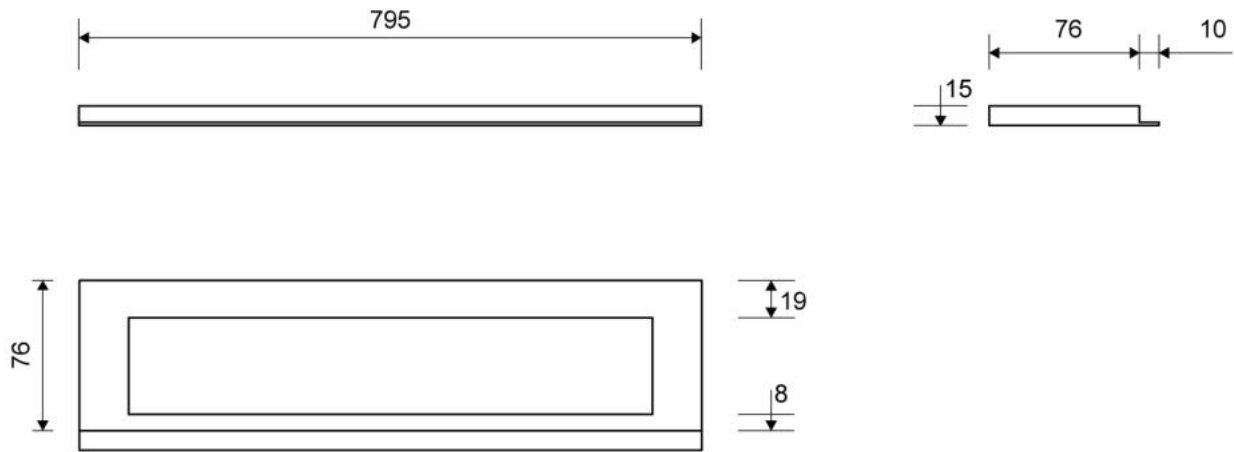

1916.0815

Products

1920.0816 - 800mm Copper Panel

HighLine Colour Panel | Copper

The set consists of a Highline Panel in Brushed Stainless Steel PVD coated Copper, heightener set and screws. Can be used with or without Highline Frame. Brass frame not available for Freestanding drain. When using without Highline Frame, ensure rear wall build up allows for equal drainage gap on all sides. Also available in Black, Brass, Brushed and Polished Stainless Steel



Specifications

ITEM NUMBER	GTIN NUMBER	MATERIAL
1920.0816	5707692011622	Stainless steel (AISI 304)
USAGE	SURFACE	LENGTH MODEL
Linear drain	PVD Copper	800 mm
FITS DRAIN UNIT	HEIGHTENER SET	LENGTH WITH/WITHOUT FRAME
1001, 1002, 1003, 1004, 1100, 5002, 5003	Plastic (PE)	733/795 mm

