

3004.0800K6NFM01 Low Profile Outlet DATA SHEET

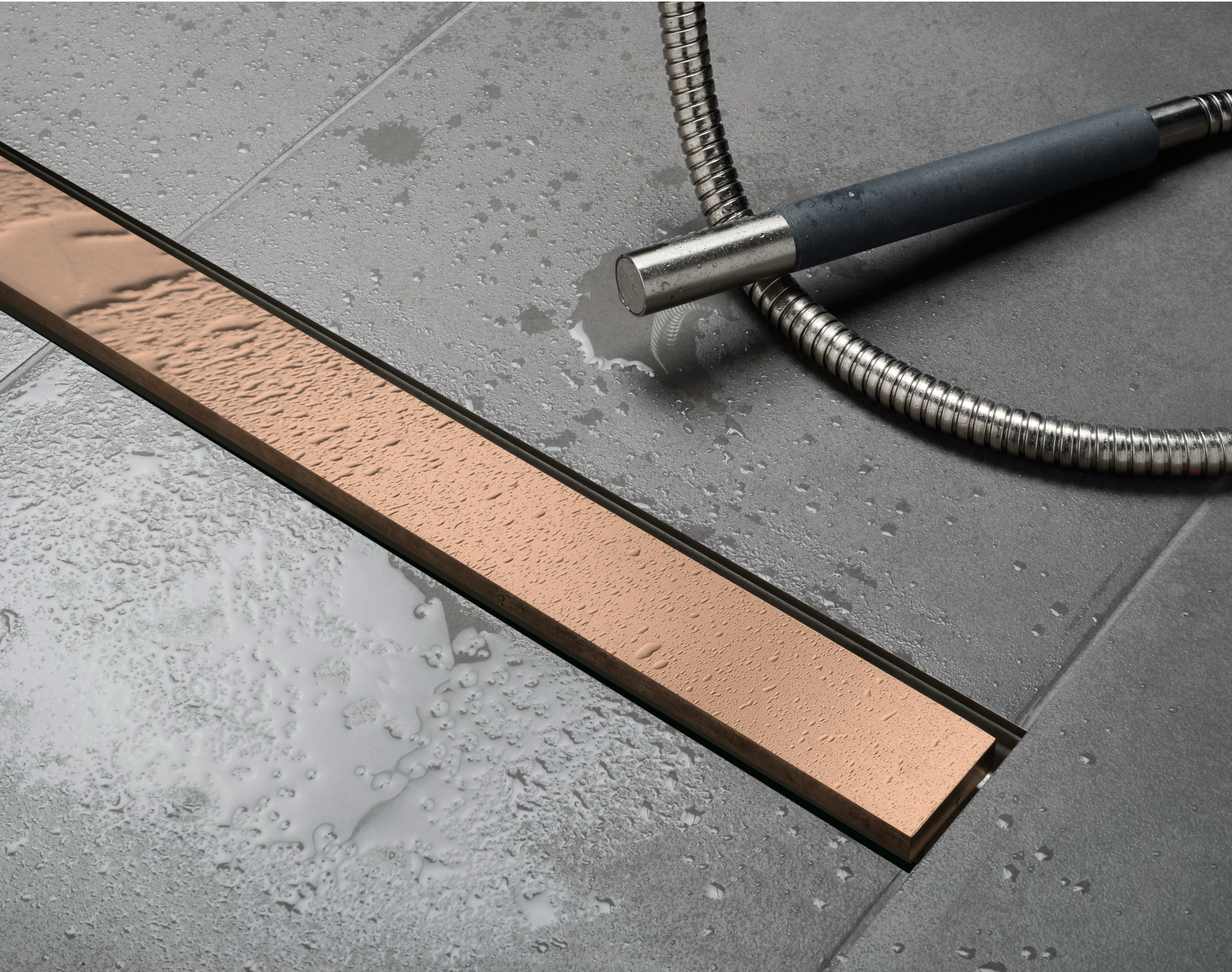

KIT CONTAINS

FREESTANDING DRAIN
INSTALLATION FEET
LOW PROFILE OUTLET
HIGHLINE PANEL COPPER

3004.0800 - 800 Model Drain Body

Line 3004

For shower cubicle with no permanent walls



Specifications

ITEM NUMBER	GTIN NUMBER	WEIGHT INCLUDING PACKAGING
3004.0800	5707692007076	4100 g
WEIGHT EXCLUDING PACKAGING	MATERIAL	USAGE
3900 g	1,5 mm stainless steel (AISI 304)	Line drain
SURFACE	MEMBRANE	FLOOR CONSTRUCTION
Pickled	Liquid or sheet membrane	All
FLOORING	MOUNTING	CENTER
Tiles	6 mm plugs 6 mm screws. Torx 20	456 mm
INSTALLATION LENGTH (L)	HEIGHT (H)	LENGTH MODEL
912 mm	18 mm	800 mm

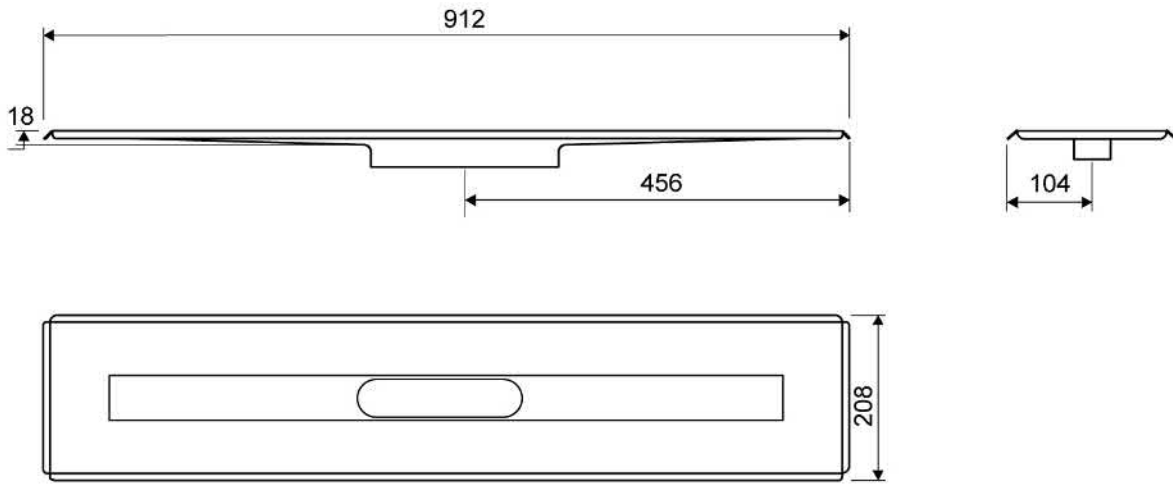

3004.0800

Height Adjustable Installation Feet

Height-adjustable feet (120-220 mm) for installation in concrete.
included with 3004 Unidrain.

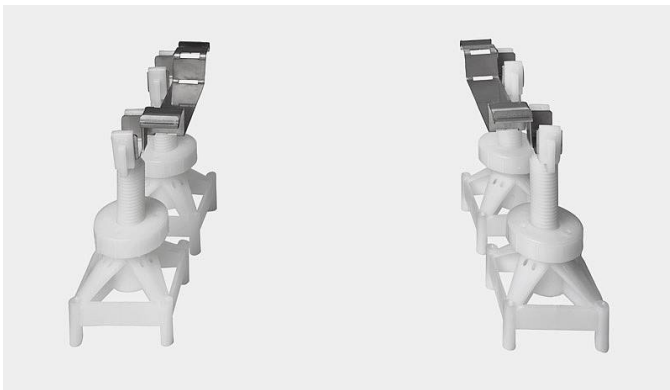

1417.0050 - Low Profile Outlet

Linear 1417.0050

Ø 50 mm horizontal drain

The odour barrier can be removed for cleaning

Can be rotated 180 degrees if a rear-facing outlet is required

Note: Odour barrier is VA-approved



Specifications

ITEM NUMBER	GTIN NUMBER	WEIGHT INCLUDING PACKAGING
1417.0050	5707692007915	500 g
WEIGHT EXCLUDING PACKAGING	MATERIAL	USAGE
350 g	Plastic (PP)	Line drain
BARRIER	GASKET	CAPACITY
With (odour barrier)	EPDM	0.6 l/s
SIDE INLET	CENTER	FITS DRAIN UNIT
Without	30 mm	1001, 1002, 1003, 1004, 1100, 3002, 3004, 5002, 5003, 4004

FITTING HEIGHTS - LINE FAUCETS 1001, 1002, 1003, 1004

Ø	Outlet direction	300	600	700	800	900	1000	1200
Ø 50 mm	Horizontal	64 mm	68 mm	69 mm	70 mm	71 mm	72 mm	74 mm

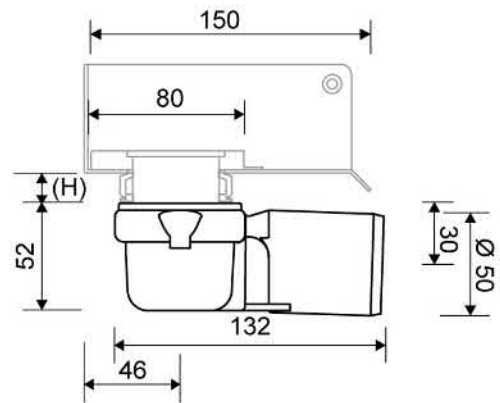
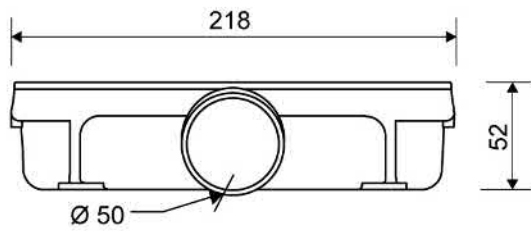
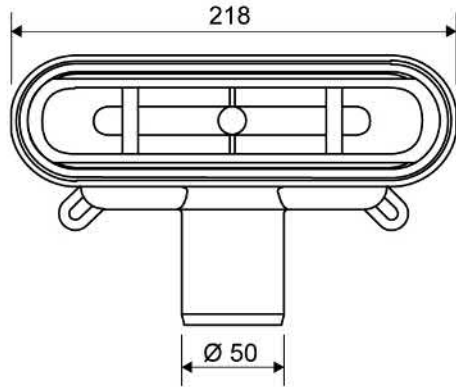

1920.0816 - 800mm Copper Panel

HighLine Colour Panel | Copper

The set consists of a Highline Panel in Brushed Stainless Steel PVD coated Copper, heightener set and screws. Can be used with or without Highline Frame. Brass frame not available for Freestanding drain. When using without Highline Frame, ensure rear wall build up allows for equal drainage gap on all sides. Also available in Black, Brass, Brushed and Polished Stainless Steel



Specifications

ITEM NUMBER	GTIN NUMBER	MATERIAL
1920.0816	5707692011622	Stainless steel (AISI 304)
USAGE	SURFACE	LENGTH MODEL
Linear drain	PVD Copper	800 mm
FITS DRAIN UNIT	HEIGHTENER SET	LENGTH WITH/WITHOUT FRAME
1001, 1002, 1003, 1004, 1100, 5002, 5003	Plastic (PE)	733/795 mm

