

1004.0300K7M01 Low Profile Outlet  
DATA SHEET



**KIT CONTAINS**

WALL MOUNTED DRAIN  
LOW PROFILE OUTLET  
HIGHLINE FRAME  
HIGHLINE PANEL

## 1004.0301 - 300 Model Drain Body

Line 1004

Wall Mounted Linear Drain fixed to wall for a very secure installation and to allow for a one way fall.  
Suitable for 25mm wall build up. For larger sizes, please contact Wet Room Materials.  
Can be freely positioned against rear wall, independent of any side walls.



### Specifications

<b>ITEM NUMBER</b>	<b>GTIN NUMBER</b>	<b>MATERIAL</b>
1004.0301	5707692008493	1.5 mm stainless steel (AISI 304)
<b>USAGE</b>	<b>SURFACE</b>	<b>MEMBRANE</b>
Linear drain	Pickled	Liquid or sheet membrane
<b>FLOOR CONSTRUCTION</b>	<b>FLOORING</b>	<b>MOUNTING</b>
All	Tiles	6 mm Pluks 6 mm Skruer. Torx 20
<b>CENTER</b>	<b>INSTALLATION LENGTH (L)</b>	<b>HEIGHT (H)</b>
216 mm	432 mm	12 mm
<b>LENGTH MODEL</b>		
300		

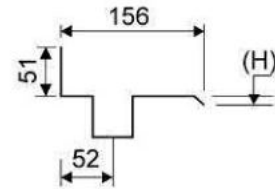
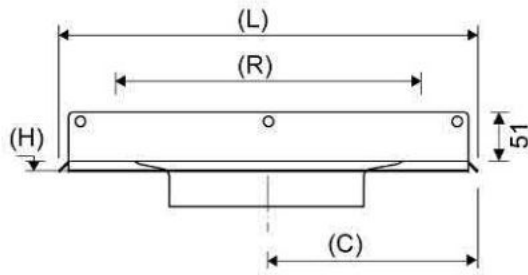
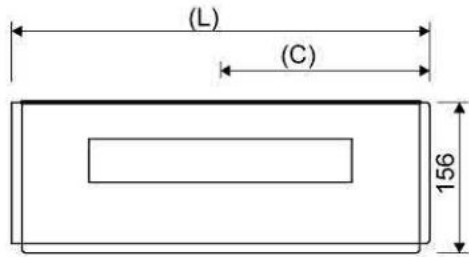

1004.0301

## 1417.0050 - Low Profile Outlet

Linear 1417.0050

Ø 50 mm horizontal drain

The odour barrier can be removed for cleaning

Can be rotated 180 degrees if a rear-facing outlet is required

Note: Odour barrier is VA-approved



### Specifications

ITEM NUMBER	GTIN NUMBER	WEIGHT INCLUDING PACKAGING
1417.0050	5707692007915	500 g
WEIGHT EXCLUDING PACKAGING	MATERIAL	USAGE
350 g	Plastic (PP)	Line drain
BARRIER	GASKET	CAPACITY
With (odour barrier)	EPDM	0.6 l/s
SIDE INLET	CENTER	FITS DRAIN UNIT
Without	30 mm	1001, 1002, 1003, 1004, 1100, 3002, 3004, 5002, 5003, 4004

FITTING HEIGHTS - LINE FAUCETS 1001, 1002, 1003, 1004

Ø	Outlet direction	300	600	700	800	900	1000	1200
Ø 50 mm	Horizontal	64 mm	68 mm	69 mm	70 mm	71 mm	72 mm	74 mm

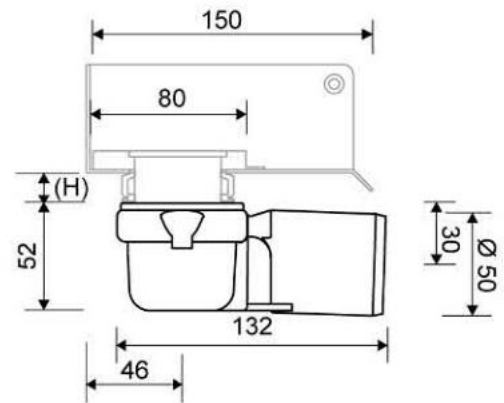

**1417.0050**

## 1917.0315 - 300 Highline frame

HighLine Colour frame | Black

Highline Frame Brushed Stainless Steel PVD Coated Black.

Also available in 10, 12 and 25mm heights (depending on the thickness of the floor tile)

Contact Wetroom Materials for other heights.

Must be installed before tiling.



### Specifications

<b>ITEM NUMBER</b>	<b>GTIN NUMBER</b>	<b>MATERIAL</b>
1917.0315	5707692011806	Stainless steel (AISI 304)
<b>USAGE</b>	<b>SURFACE</b>	<b>INSTALLATION LENGTH (L2)</b>
Linear drain	PVD Black	315 mm
<b>HEIGHT (H)</b>	<b>LENGTH MODEL</b>	<b>FITS DRAIN UNIT</b>
H 15 mm	300 mm	1001, 1002, 1003, 1004, 1100, 5002, 5003
<b>INSERT</b>		
Synthetic		

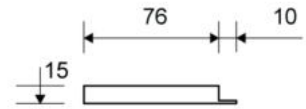
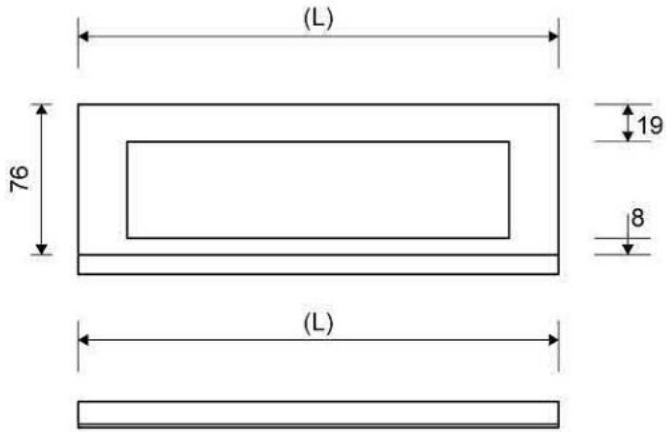

# 1920.0317    1920.0317 - 300 Highline Panel

HighLine Colour Panel | Black

The set consists of a Highline Panel in Brushed Stainless Steel PVD coated Black, heightener set and screws. Can be used with or without Highline Frame. Black frame not available for Freestanding drain. When using without Highline Frame, ensure rear wall build up allows for equal drainage gap on all sides. Also available in Copper, Brass, Brushed and Polished Stainless Steel



## Specifications

<b>ITEM NUMBER</b>	<b>GTIN NUMBER</b>	<b>MATERIAL</b>
1920.0317	5707692009834	Stainless steel (AISI 304)
<b>USAGE</b>	<b>SURFACE</b>	<b>LENGTH MODEL</b>
Linear drain	PVD Black	300 mm
<b>FITS DRAIN UNIT</b>	<b>HEIGHTENER SET</b>	<b>LENGTH WITH/WITHOUT FRAME</b>
1001, 1002, 1003, 1004, 1100, 5002, 5003	Plastic (PE)	253/315 mm



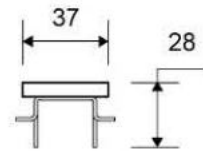
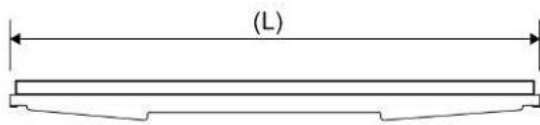
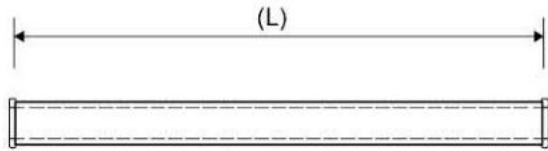

**1920.0317**