

3004.0800K8NF Standard Outlet DATA SHEET

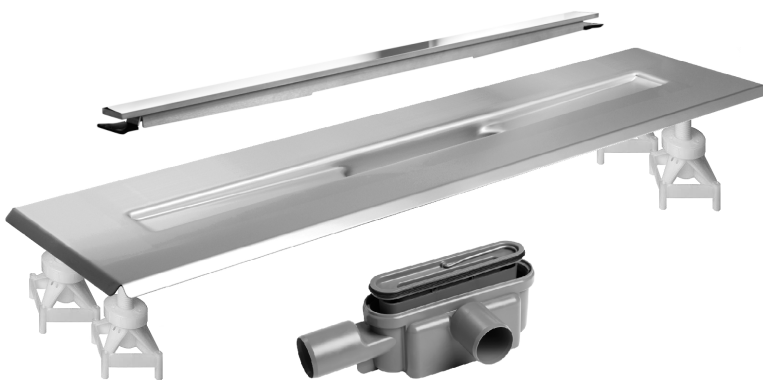

KIT CONTAINS

FREESTANDING DRAIN
INSTALLATION FEET
MULTI DIRECTIONAL OUTLET
HIGHLINE PANEL POLISHED
STAINLESS STEEL

3004.0800 - 800 Model Drain Body

Line 3004

For shower cubicle with no permanent walls



Specifications

ITEM NUMBER	GTIN NUMBER	WEIGHT INCLUDING PACKAGING
3004.0800	5707692007076	4100 g
WEIGHT EXCLUDING PACKAGING	MATERIAL	USAGE
3900 g	1,5 mm stainless steel (AISI 304)	Line drain
SURFACE	MEMBRANE	FLOOR CONSTRUCTION
Pickled	Liquid or sheet membrane	All
FLOORING	MOUNTING	CENTER
Tiles	6 mm plugs 6 mm screws. Torx 20	456 mm
INSTALLATION LENGTH (L)	HEIGHT (H)	LENGTH MODEL
912 mm	18 mm	800 mm

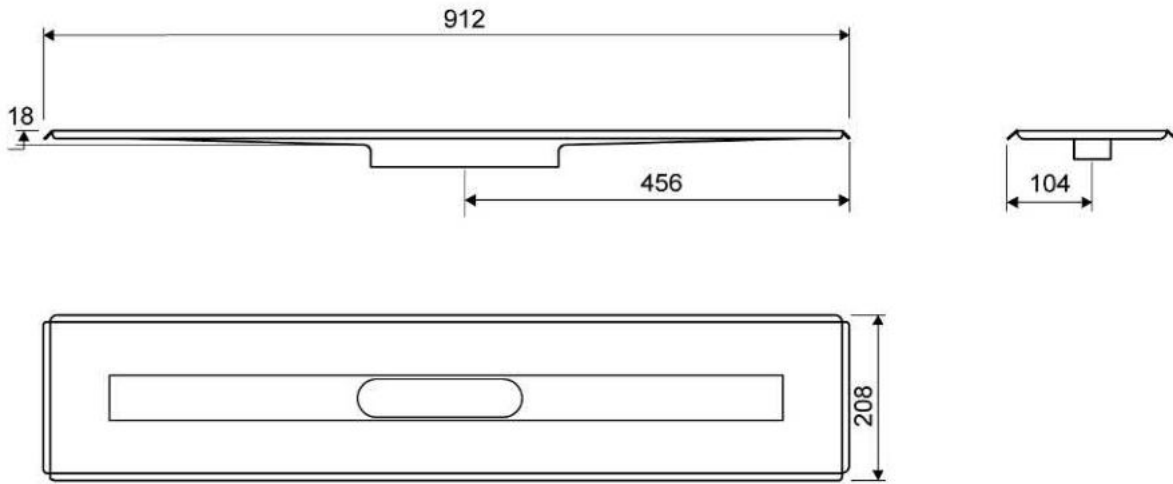

3004.0800

Height Adjustable Installation Feet

Height-adjustable feet (120-220 mm) for installation in concrete.
included with 3004 Unidrain.

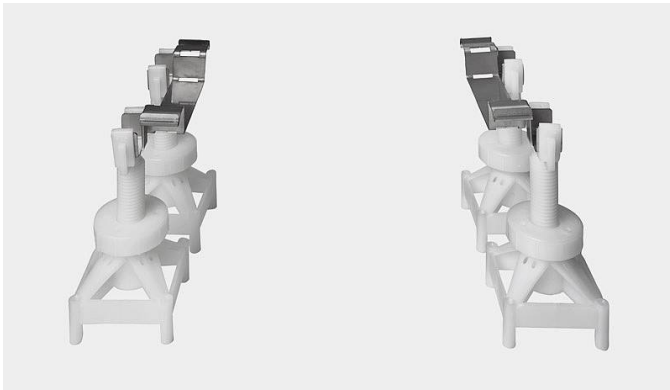

1416.0050 - Multi Directional Outlet

Line 1416.0050

Ø 50 mm horizontal drain

Can be rotated 180 degrees if a rear-facing outlet is required.

Note two drains. Cannot be used as an inlet.



Specifications

ITEM NUMBER	GTIN NUMBER	WEIGHT INCLUDING PACKAGING
1416.0050	5707692012520	505 g
WEIGHT EXCLUDING PACKAGING	MATERIAL	USAGE
312 g	Plastic (PP)	Line drain
BARRIER	GASKET	CAPACITY
With	EPDM	0,8 l/s
SIDE INLET	CENTER	FITS DRAIN UNIT
Without	32 mm	1001, 1002, 1003, 1004, 1100, 3002, 3004, 5002, 5003, 4004

FITTING HEIGHTS - LINE FAUCETS 1001, 1002, 1003, 1004

Ø	Outlet direction	300	600	700	800	900	1000	1200
Ø 50 mm	Horizontal	98 mm	102 mm	103 mm	104 mm	105 mm	106 mm	108 mm

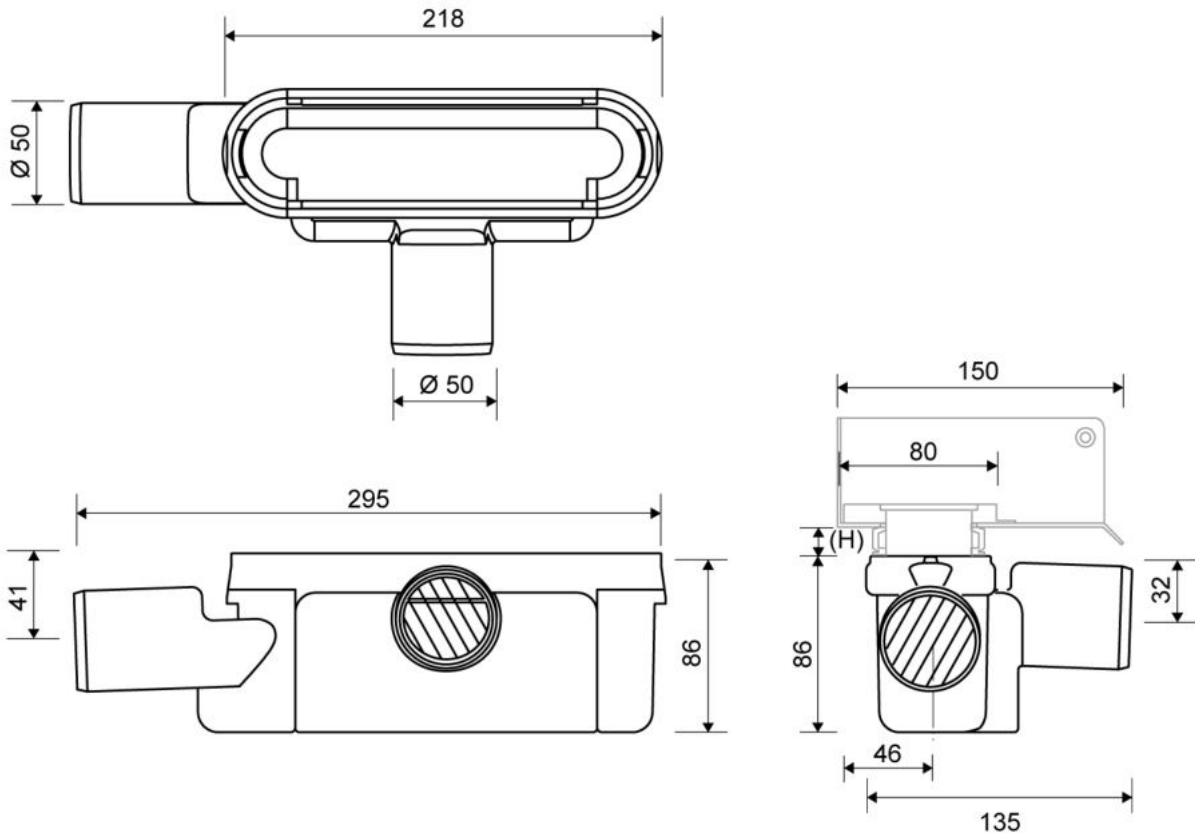

1920.0818 - 800mm Polished Steel Panel

HighLine Colour Panel | hand polished steel

The set consists of a Highline Panel in Polished Stainless Steel, heightener set and screws.
 Can be used with or without Highline Frame. Polished frame not available for Freestanding drain.
 When using without Highline Frame, ensure rear wall build up allows for equal drainage gap on all sides. Also available in Black, Brass, Copper and Brushed Stainless Steel



Specifications

ITEM NUMBER	GTIN NUMBER	MATERIAL
1920.0818	5707692011646	Stainless steel (AISI 304)
USAGE	SURFACE	LENGTH MODEL
Linear drain	Hand polished steel	800 mm
FITS DRAIN UNIT	HEIGHTENER SET	LENGTH WITH/WITHOUT FRAME
1001, 1002, 1003, 1004, 1100, 5002, 5003	Plastic (PE)	733/795 mm

