

WM4004.0700 LOW PROFILE OUTLET DATA SHEET



KIT CONTAINS

VINYL FLOOR DRAIN
LOW PROFILE OUTLET
FRAME TO SECURE VINYL
BRUSHED STAINLESS STEEL
MAGNETIC GRATE

4004.0700 - 700 Model Drain Body

Vinyl set 4004

For shower cubicle with no fixed walls

The vinyl set comprises a magnetic fitting, frame and grating



Specifications

ITEM NUMBER 4004.0700	GTIN NUMBER 5707692009599	USAGE Linear drain
CENTER 375 mm	HEIGHT (H) 24 mm	LENGTH MODEL 700 mm
GRATING 685 mm		

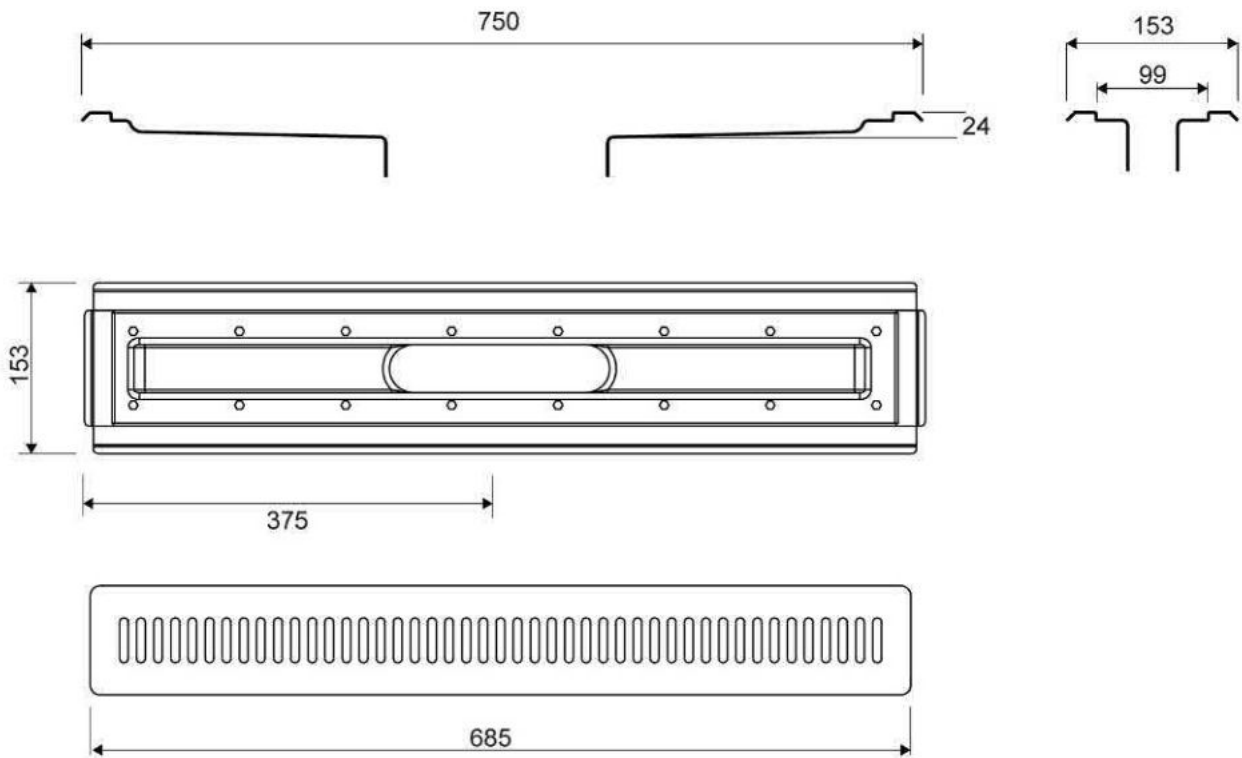

4004.0700

1417.0050 - Low profile Outlet

Linear 1417.0050

Ø 50 mm horizontal drain

The odour barrier can be removed for cleaning

Can be rotated 180 degrees if a rear-facing outlet is required

Note: Odour barrier is VA-approved



Specifications

ITEM NUMBER	GTIN NUMBER	WEIGHT INCLUDING PACKAGING
1417.0050	5707692007915	500 g
WEIGHT EXCLUDING PACKAGING	MATERIAL	USAGE
350 g	Plastic (PP)	Line drain
BARRIER	GASKET	CAPACITY
With (odour barrier)	EPDM	0.6 l/s
SIDE INLET	CENTER	FITS DRAIN UNIT
Without	30 mm	1001, 1002, 1003, 1004, 1100, 3002, 3004, 5002, 5003, 4004

FITTING HEIGHTS - LINE FAUCETS 1001, 1002, 1003, 1004

Ø	Outlet direction	300	600	700	800	900	1000	1200
Ø 50 mm	Horizontal	64 mm	68 mm	69 mm	70 mm	71 mm	72 mm	74 mm

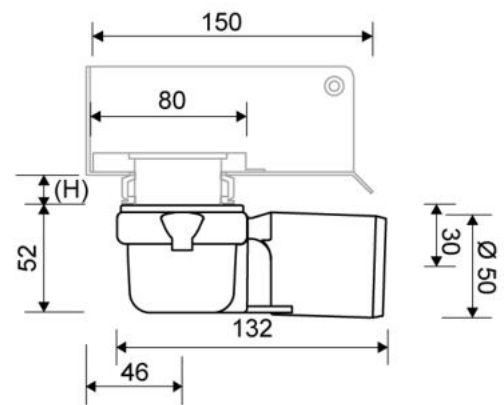
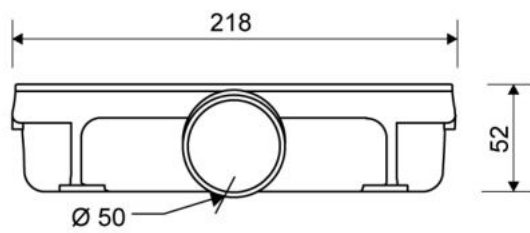
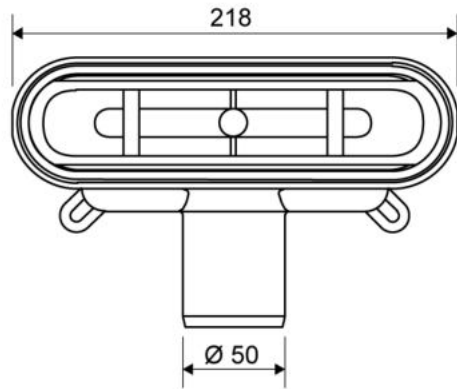

1417.0050