

1004.2000K8M01 Low Profile Outlet  
DATA SHEET



**KIT CONTAINS**

WALL MOUNTED DRAIN  
LOW PROFILE OUTLET  
HIGHLINE FRAME  
HIGHLINE PANEL

## 1004.2001 - 2000 Model Drain Body

Line 1004

Wall Mounted Linear Drain fixed to wall for a very secure installation and to allow for a one way fall. Suitable for 25mm wall build up. For larger sizes, please contact Wet Room Materials. Can be freely positioned against rear wall, independent of any side walls.



### Specifications

<b>ITEM NUMBER</b>	<b>GTIN NUMBER</b>	<b>MATERIAL</b>
1004.2001	5707692008387	1.5 mm stainless steel (AISI 304)
<b>USAGE</b>	<b>SURFACE</b>	<b>MEMBRANE</b>
Linear drain	Pickled	Liquid or sheet membrane
<b>FLOOR CONSTRUCTION</b>	<b>FLOORING</b>	<b>MOUNTING</b>
All	Tiles	6 mm Pluks 6 mm Skruer. Torx 20
<b>CENTER</b>	<b>INSTALLATION LENGTH (L)</b>	<b>HEIGHT (H)</b>
556 mm	2109 mm	19 mm
<b>LENGTH MODEL</b>		
2000		

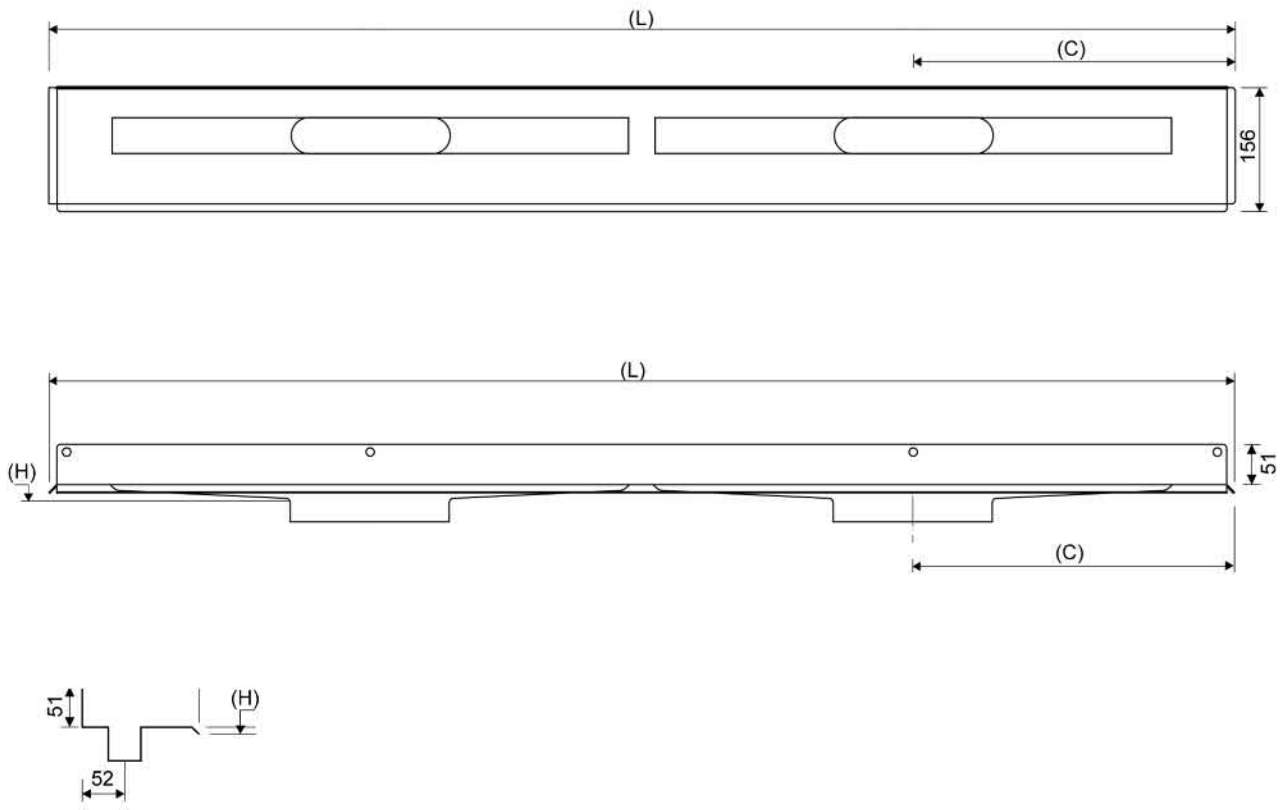

## 1417.0050 - Low Profile Outlet

Linear 1417.0050

Ø 50 mm horizontal drain

The odour barrier can be removed for cleaning

Can be rotated 180 degrees if a rear-facing outlet is required

Note: Odour barrier is VA-approved



### Specifications

ITEM NUMBER	GTIN NUMBER	WEIGHT INCLUDING PACKAGING
1417.0050	5707692007915	500 g
WEIGHT EXCLUDING PACKAGING	MATERIAL	USAGE
350 g	Plastic (PP)	Line drain
BARRIER	GASKET	CAPACITY
With (odour barrier)	EPDM	0.6 l/s
SIDE INLET	CENTER	FITS DRAIN UNIT
Without	30 mm	1001, 1002, 1003, 1004, 1100, 3002, 3004, 5002, 5003, 4004

FITTING HEIGHTS - LINE FAUCETS 1001, 1002, 1003, 1004

Ø	Outlet direction	300	600	700	800	900	1000	1200
Ø 50 mm	Horizontal	64 mm	68 mm	69 mm	70 mm	71 mm	72 mm	74 mm

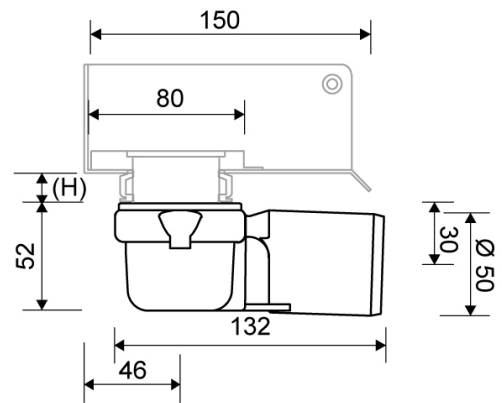
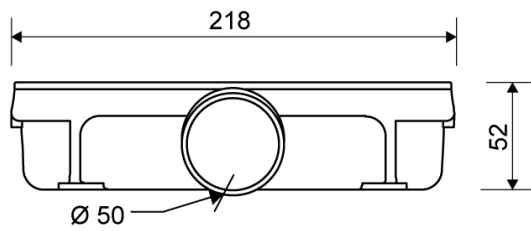
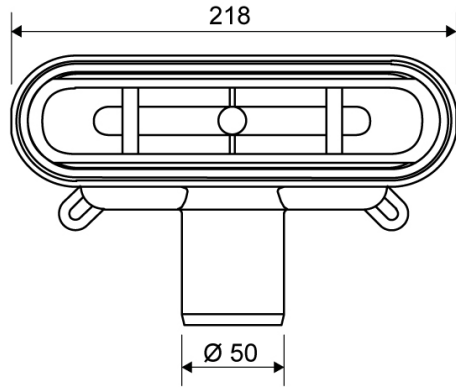

# 1918.1015 - Highline Frame

HighLine Colour frame | Hand polished steel

Highline Frame Polished Stainless Steel.

Also available in 10, 12 and 25mm heights (depending on the thickness of the floor tile)  
Contact Wetroom Materials for other heights.

Must be installed before tiling.



## Specifications

<b>ITEM NUMBER</b>	<b>GTIN NUMBER</b>	<b>MATERIAL</b>
1918.1015	5707692012315	Stainless steel (AISI 304)
<b>USAGE</b>	<b>SURFACE</b>	<b>INSTALLATION LENGTH (L2)</b>
Linear drain	Hand polished steel	995 mm
<b>HEIGHT (H)</b>	<b>LENGTH MODEL</b>	<b>FITS DRAIN UNIT</b>
H 15 mm	1000 mm	1001, 1002, 1003, 1004, 1100, 5002, 5003
<b>INSERT</b>		
Synthetic		

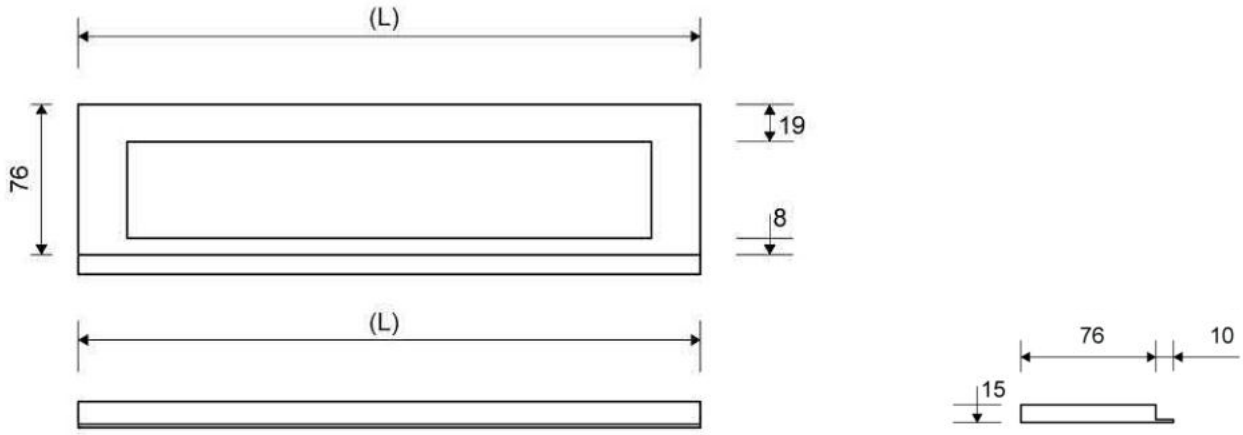

## 1920.1018 - 1000mm Highline Panel

HighLine Colour Panel | hand polished steel

The set consists of a Highline Panel in Polished Stainless Steel, heightener set and screws.  
 Can be used with or without Highline Frame. Polished frame not available for Freestanding drain.  
 When using without Highline Frame, ensure rear wall build up allows for equal drainage gap on all sides. Also available in Black, Brass, Copper and Brushed Stainless Steel



### Specifications

<b>ITEM NUMBER</b>	<b>GTIN NUMBER</b>	<b>MATERIAL</b>
1920.1018	5707692011684	Stainless steel (AISI 304)
<b>USAGE</b>	<b>SURFACE</b>	<b>LENGTH MODEL</b>
Linear drain	Hand polished steel	1000 mm
<b>FITS DRAIN UNIT</b>	<b>HEIGHTENER SET</b>	<b>LENGTH WITH/WITHOUT FRAME</b>
1001, 1002, 1003, 1004, 1100, 5002, 5003	Plastic (PE)	933/995 mm



## 1920.1018 - 1000mm Highline Panel

