

## 1K1800.16607NFM

Kit Size 1800mm x 1660mm - Low Profile Outlet

Can be trimmed to 1509mm x 1200mm



### KIT CONTAINS

WALL MOUNTED DRAIN  
LOW PROFILE OUTLET  
HIGHLINE PANEL  
UNISLOPE PREFORMED  
BOARDS  
TANKING KIT

## 1004.1401 - 1400 Model Drain Body

Line 1004

Wall Mounted Linear Drain fixed to wall for a very secure installation and to allow for a one way fall. Suitable for 25mm wall build up. For larger sizes, please contact Wet Room Materials. Can be freely positioned against rear wall, independent of any side walls.



### Specifications

<b>ITEM NUMBER</b>	<b>GTIN NUMBER</b>	<b>MATERIAL</b>
1004.1401	5707692008387	1.5 mm stainless steel (AISI 304)
<b>USAGE</b>	<b>SURFACE</b>	<b>MEMBRANE</b>
Linear drain	Pickled	Liquid or sheet membrane
<b>FLOOR CONSTRUCTION</b>	<b>FLOORING</b>	<b>MOUNTING</b>
All	Tiles	6 mm Pluks 6 mm Skruer. Torx 20
<b>CENTER</b>	<b>INSTALLATION LENGTH (L)</b>	<b>HEIGHT (H)</b>
406 mm	1509 mm	17 mm
<b>LENGTH MODEL</b>		
1400		

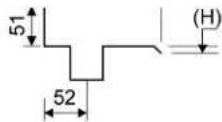
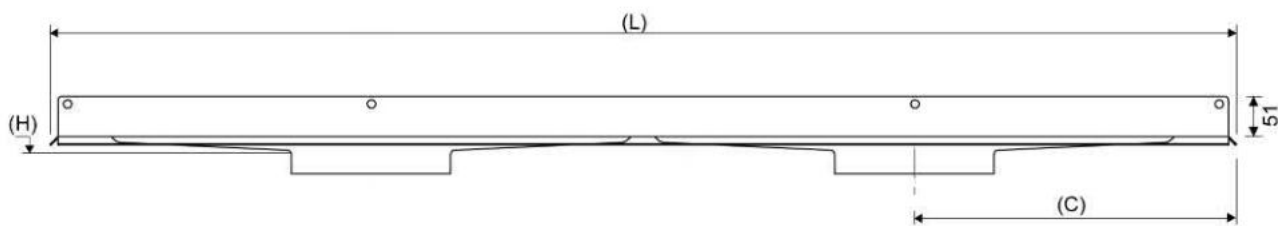
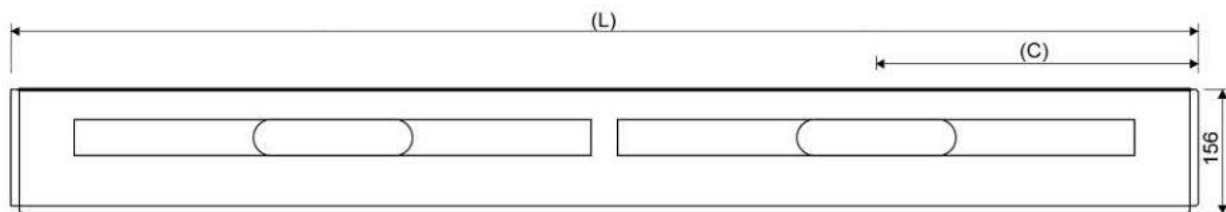

## 1417.0050 - Low Profile Outlet

Linear 1417.0050

Ø 50 mm horizontal drain

The odour barrier can be removed for cleaning

Can be rotated 180 degrees if a rear-facing outlet is required

Note: Odour barrier is VA-approved



### Specifications

ITEM NUMBER	GTIN NUMBER	WEIGHT INCLUDING PACKAGING
1417.0050	5707692007915	500 g
WEIGHT EXCLUDING PACKAGING	MATERIAL	USAGE
350 g	Plastic (PP)	Line drain
BARRIER	GASKET	CAPACITY
With (odour barrier)	EPDM	0.6 l/s
SIDE INLET	CENTER	FITS DRAIN UNIT
Without	30 mm	1001, 1002, 1003, 1004, 1100, 3002, 3004, 5002, 5003, 4004

FITTING HEIGHTS - LINE FAUCETS 1001, 1002, 1003, 1004

Ø	Outlet direction	300	600	700	800	900	1000	1200
Ø 50 mm	Horizontal	64 mm	68 mm	69 mm	70 mm	71 mm	72 mm	74 mm

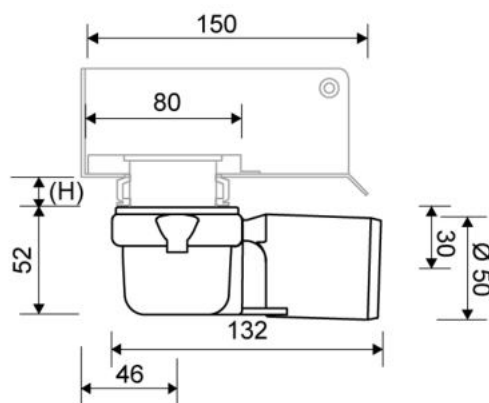
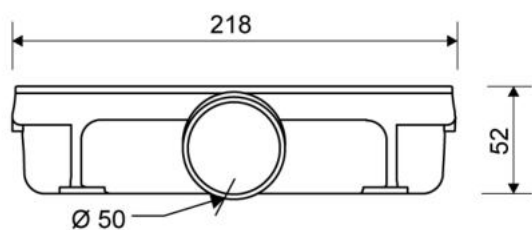

## 1920.0717 - 700mm Black Panel

HighLine Colour Panel | Black

The set consists of a Highline Panel in Brushed Stainless Steel PVD coated Black, heightener set and screws. Can be used with or without Highline Frame. Brass frame not available for Freestanding drain. When using without Highline Frame, ensure rear wall build up allows for equal drainage gap on all sides. Also available in Copper, Brass, Brushed and Polished Stainless Steel



### Specifications

<b>ITEM NUMBER</b>	<b>GTIN NUMBER</b>	<b>MATERIAL</b>
1920.0717	5707692009841	Stainless steel (AISI 304)
<b>USAGE</b>	<b>SURFACE</b>	<b>LENGTH MODEL</b>
Linear drain	PVD Black	700 mm
<b>FITS DRAIN UNIT</b>	<b>HEIGHTENER SET</b>	<b>LENGTH WITH/WITHOUT FRAME</b>
1001, 1002, 1003, 1004, 1100, 5002, 5003	Plastic (PE)	633/695 mm

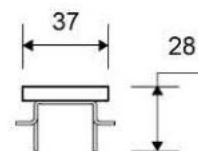
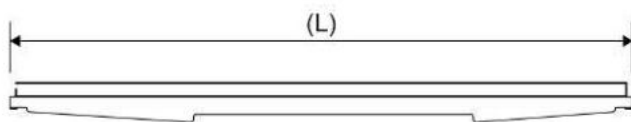
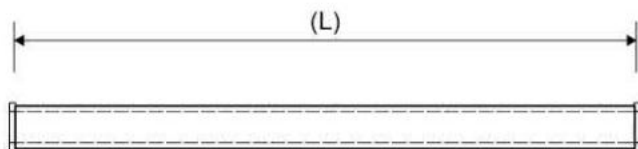

## 1K1800.1660 - 1800x1660mm Board

UniSlope preformed Board with one way slope / fall built in.

To be used with Unidrain wall mounted linear drain



### Specifications

**Material:** High Density PVC Foam Board (Foamed Rigid Polyvinyl Chloride Board)

**Size with drain:** 1800 x 1660mm

**Board thickness:** 30mm sloping to drain (21mm fall)

**Weight:** 30kg

**Density:** 50 kg/m<sup>3</sup>

**Tensile Strength:** 11MPa

**Impact Strength:** 12.8KJ/m<sup>2</sup>

**Thermal Conductivity:** 0.07 W/mK

**Temperature Range:** -10°C, +55°C

**Colour:** White

**NFPA Rating:** Health=1, Fire=0, Reactivity=0

**Hazards Identification:** No particular hazards known

**First aid measures:** In general handling the material will not cause accidents.

**Notes:** Dust masks must be worn when cutting UniSlope boards. UniSlope Boards are not load bearing and must be installed on a strong wood or concrete subfloor which is level. Follow UniSlope installation instructions.

**Refer to UniSlope kit drawings and safety data sheet for more information**



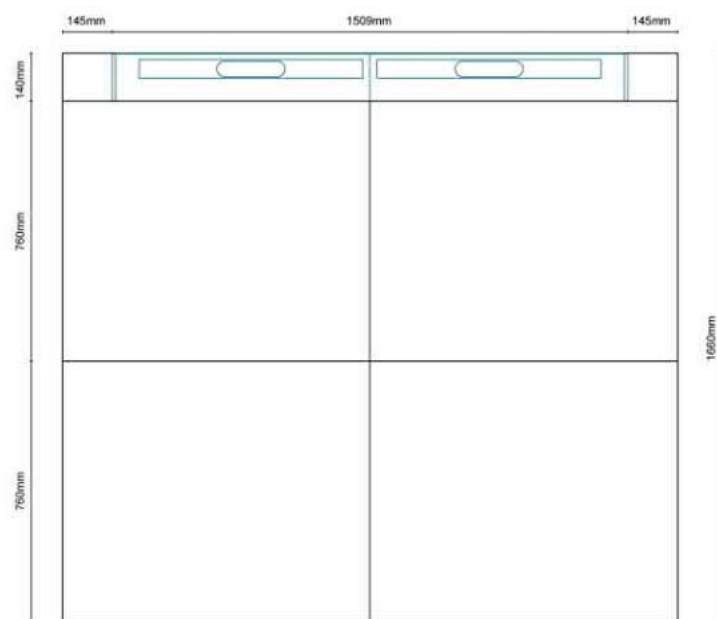
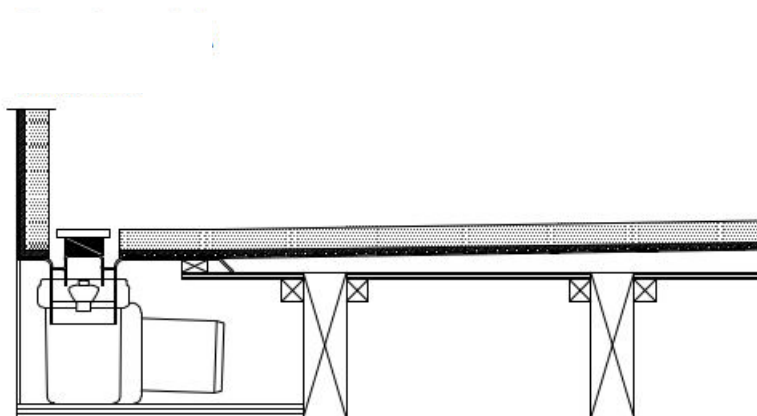

**Refer to UniSlope kit drawings and safety data sheet for more information**

## WMVS30K - Waterproofing Kit

Easy application paint on liquid membrane for waterproofing wet rooms and bathrooms

Contains 12kg liquid membrane, 25m reinforcement trap and 1l primer.



### Specifications

**Material:** acrylic polymers, plasticizer, water and preservative

**Coverage:** 7m<sup>2</sup>

**Can be applied to:** Wood, concrete, metal, plastic, plaster, light clincer concrete, screed, lightweight concrete, stucco, gypsum floors, calcium, silicate plates and various approved wet room plaster boards, gypsum fibre, cement and polystyrene.

**Drying time:** 1st layer 1-2 hours at 18-20°C. 2nd layer approx 12 hours at 18-20°C.  
Drying times will vary depending on temperature, ventilation and substrate.

**Application method:** Paint brush and roller.

**Notes:** Room must be primed with Primer 54 included before applying liquid membrane. All major joints must be reinforced using LIP reinforcement tape included. Ensure all areas are dry after each stage before proceeding i.e. Priming, 1st coat and 2nd coat before proceeding. No one can access the area whilst membrane is drying. Once 2nd coat is completely dry, cover membrane with a suitable protective sheet / board until tiled. If a heater is required, do not place too close to the membrane.

**Refer to installation instructions and safety data sheet for more information.**