

1K0900.16608NFM

Kit Size 900mm x 900mm - Low Profile Outlet

Can be trimmed to 812mm x 1200mm



KIT CONTAINS

WALL MOUNTED DRAIN
STANDARD OUTLET
HIGHLINE PANEL
UNISLOPE PREFORMED
BOARDS
TANKING KIT

1004.0701 - 700 Model Drain Body

Line 1004

Wall Mounted Linear Drain fixed to wall for a very secure installation and to allow for a one way fall. Suitable for 25mm wall build up. For larger sizes, please contact Wet Room Materials. Can be freely positioned against rear wall, independent of any side walls.



Specifications

| | | |
|---------------------------|--------------------------------|-----------------------------------|
| ITEM NUMBER | GTIN NUMBER | MATERIAL |
| 1004.0701 | 5707692008387 | 1.5 mm stainless steel (AISI 304) |
| USAGE | SURFACE | MEMBRANE |
| Linear drain | Pickled | Liquid or sheet membrane |
| FLOOR CONSTRUCTION | FLOORING | MOUNTING |
| All | Tiles | 6 mm Pluks 6 mm Skruer. Torx 20 |
| CENTER | INSTALLATION LENGTH (L) | HEIGHT (H) |
| 406 mm | 812 mm | 17 mm |
| LENGTH MODEL | | |
| 700 | | |

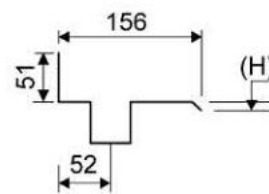
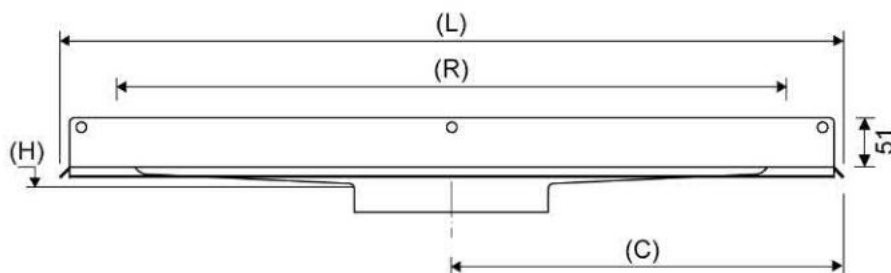
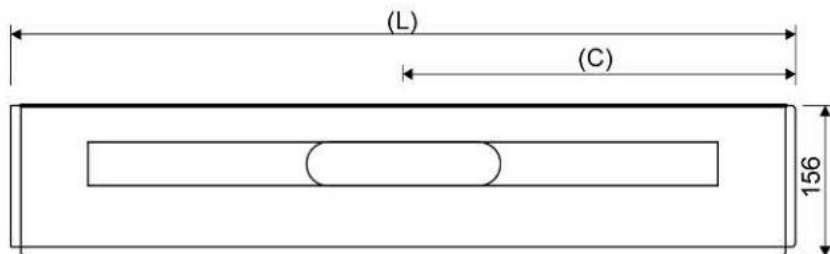

1417.0050 - Low Profile Outlet

Linear 1417.0050

Ø 50 mm horizontal drain

The odour barrier can be removed for cleaning

Can be rotated 180 degrees if a rear-facing outlet is required

Note: Odour barrier is VA-approved



Specifications

| | | |
|----------------------------|---------------|--|
| ITEM NUMBER | GTIN NUMBER | WEIGHT INCLUDING PACKAGING |
| 1417.0050 | 5707692007915 | 500 g |
| WEIGHT EXCLUDING PACKAGING | MATERIAL | USAGE |
| 350 g | Plastic (PP) | Line drain |
| BARRIER | GASKET | CAPACITY |
| With (odour barrier) | EPDM | 0.6 l/s |
| SIDE INLET | CENTER | FITS DRAIN UNIT |
| Without | 30 mm | 1001, 1002, 1003, 1004, 1100, 3002, 3004, 5002, 5003, 4004 |

FITTING HEIGHTS - LINE FAUCETS 1001, 1002, 1003, 1004

| Ø | Outlet direction | 300 | 600 | 700 | 800 | 900 | 1000 | 1200 |
|---------|------------------|-------|-------|-------|-------|-------|-------|-------|
| Ø 50 mm | Horizontal | 64 mm | 68 mm | 69 mm | 70 mm | 71 mm | 72 mm | 74 mm |

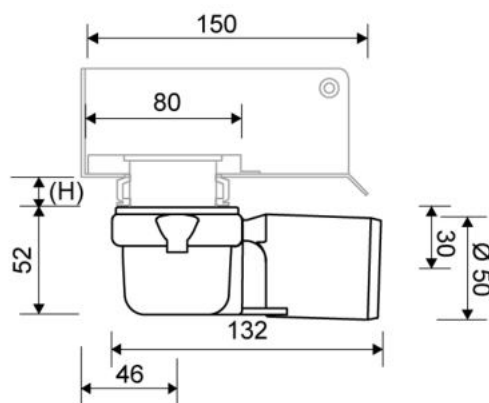
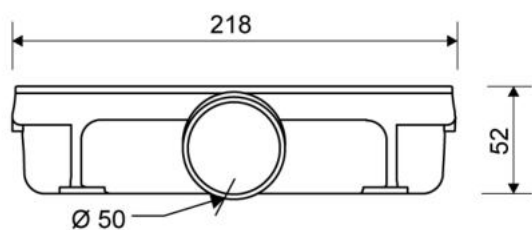

1920.0718 - 700mm Polished Steel Panel

HighLine Colour Panel | hand polished steel

The set consists of a Highline Panel in Polished Stainless Steel, heightener set and screws.
Can be used with or without Highline Frame. Polished frame not available for Freestanding drain.
When using without Highline Frame, ensure rear wall build up allows for equal drainage gap on all sides. Also available in Black, Brass, Copper and Brushed Stainless Steel



Specifications

| | | |
|--|-----------------------|----------------------------------|
| ITEM NUMBER | GTIN NUMBER | MATERIAL |
| 1920.0718 | 5707692010151 | Stainless steel (AISI 304) |
| USAGE | SURFACE | LENGTH MODEL |
| Linear drain | Hand polished steel | 700 mm |
| FITS DRAIN UNIT | HEIGHTENER SET | LENGTH WITH/WITHOUT FRAME |
| 1001, 1002, 1003, 1004, 1100, 5002, 5003 | Plastic (PE) | 633/695 mm |

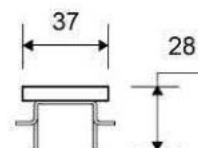
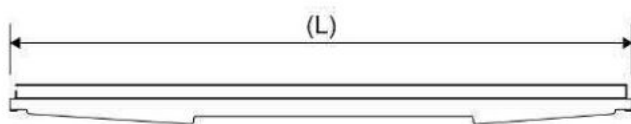
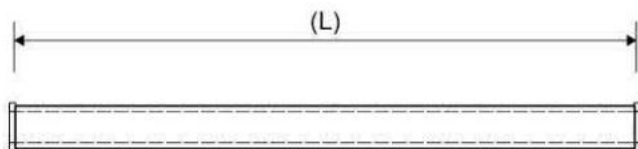

1K0900.1660 - 900x1660mm Board

UniSlope preformed Board with one way slope / fall built in.

To be used with Unidrain wall mounted linear drain



Specifications

Material: High Density PVC Foam Board (Foamed Rigid Polyvinyl Chloride Board)

Size with drain: 900 x 1660mm

Board thickness: 30mm sloping to drain (21mm fall)

Weight: 15kg

Density: 50 kg/m³

Tensile Strength: 11MPa

Impact Strength: 12.8KJ/m²

Thermal Conductivity: 0.07 W/mK

Temperature Range: -10°C, +55°C

Colour: White

NFPA Rating: Health=1, Fire=0, Reactivity=0

Hazards Identification: No particular hazards known

First aid measures: In general handling the material will not cause accidents.

Notes: Dust masks must be worn when cutting UniSlope boards. UniSlope Boards are not load bearing and must be installed on a strong wood or concrete subfloor which is level. Follow UniSlope installation instructions.

Refer to UniSlope kit drawings and safety data sheet for more information

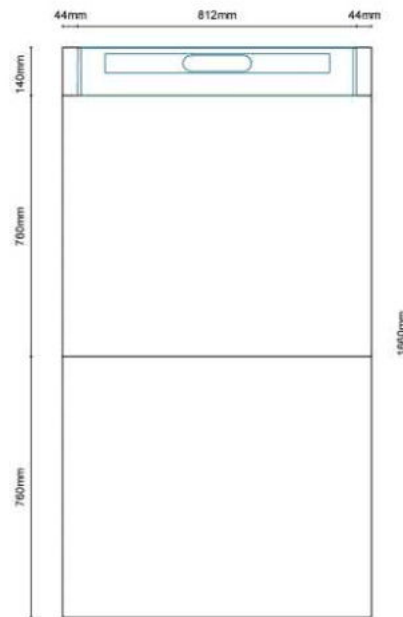
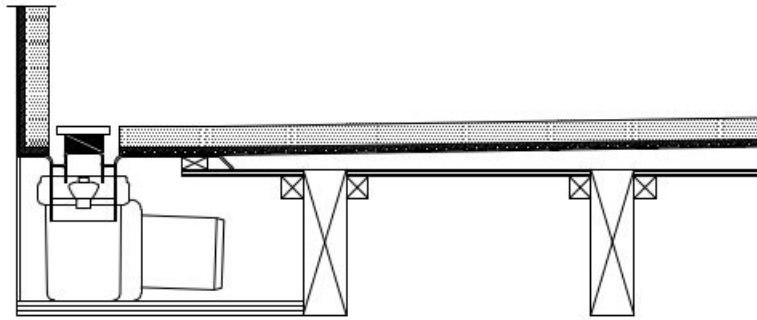

Refer to UniSlope kit drawings and safety data sheet for more information

WMVS30K - Waterproofing Kit

Easy application paint on liquid membrane for waterproofing wet rooms and bathrooms

Contains 12kg liquid membrane, 25m reinforcement trap and 1l primer.



Specifications

Material: acrylic polymers, plasticizer, water and preservative

Coverage: 7m²

Can be applied to: Wood, concrete, metal, plastic, plaster, light clincer concrete, screed, lightweight concrete, stucco, gypsum floors, calcium, silicate plates and various approved wet room plaster boards, gypsum fibre, cement and polystyrene.

Drying time: 1st layer 1-2 hours at 18-20°C. 2nd layer approx 12 hours at 18-20°C.
Drying times will vary depending on temperature, ventilation and substrate.

Application method: Paint brush and roller.

Notes: Room must be primed with Primer 54 included before applying liquid membrane. All major joints must be reinforced using LIP reinforcement tape included. Ensure all areas are dry after each stage before proceeding i.e. Priming, 1st coat and 2nd coat before proceeding. No one can access the area whilst membrane is drying. Once 2nd coat is completely dry, cover membrane with a suitable protective sheet / board until tiled. If a heater is required, do not place too close to the membrane.

Refer to installation instructions and safety data sheet for more information.