

**1K0750.12002**

Kit Size 750mm x 1200mm

Can be trimmed to 432mm x 900mm



## KIT CONTAINS

WALL MOUNTED DRAIN  
MULTI DIRECTIONAL OUTLET  
HIGHLINE CUSTOM  
UNISLOPE PREFORMED  
BOARD  
TANKING KIT

## 1004.0301 - 300mm Drain Body

Line 1004

Wall Mounted Linear Drain fixed to wall for a very secure installation and to allow for a one way fall. Suitable for 25mm wall build up. For larger sizes, please contact Wet Room Materials. Can be freely positioned against rear wall, independent of any side walls.

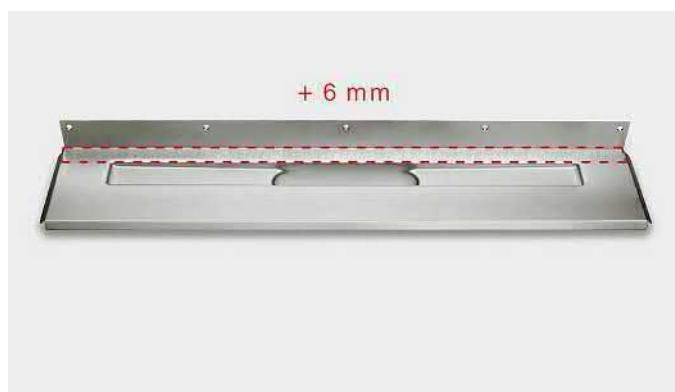

### Specifications

<b>ITEM NUMBER</b>	<b>GTIN NUMBER</b>	<b>MATERIAL</b>
1004.0301	5707692008493	1.5 mm stainless steel (AISI 304)
<b>USAGE</b>	<b>SURFACE</b>	<b>MEMBRANE</b>
Linear drain	Pickled	Liquid or sheet membrane
<b>FLOOR CONSTRUCTION</b>	<b>FLOORING</b>	<b>MOUNTING</b>
All	Tiles	6 mm Pluks 6 mm Skruer. Torx 20
<b>CENTER</b>	<b>INSTALLATION LENGTH (L)</b>	<b>HEIGHT (H)</b>
216 mm	432 mm	12 mm
<b>LENGTH MODEL</b>		
300		

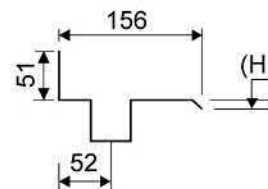
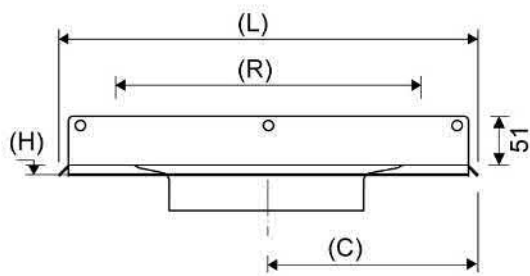
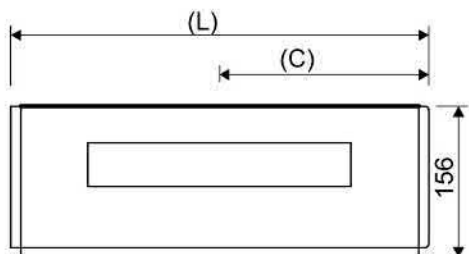

## 1416.0050 - Multi Directional Outlet

Line 1416.0050

Ø 50 mm horizontal drain

Can be rotated 180 degrees if a rear-facing outlet is required.

Note two drains. Cannot be used as an inlet.



### Specifications

ITEM NUMBER	GTIN NUMBER	WEIGHT INCLUDING PACKAGING
1416.0050	5707692012520	505 g
WEIGHT EXCLUDING PACKAGING	MATERIAL	USAGE
312 g	Plastic (PP)	Line drain
BARRIER	GASKET	CAPACITY
With	EPDM	0,8 l/s
SIDE INLET	CENTER	FITS DRAIN UNIT
Without	32 mm	1001, 1002, 1003, 1004, 1100, 3002, 3004, 5002, 5003, 4004

#### FITTING HEIGHTS - LINE FAUCETS 1001, 1002, 1003, 1004

Ø	Outlet direction	300	600	700	800	900	1000	1200
Ø 50 mm	Horizontal	98 mm	102 mm	103 mm	104 mm	105 mm	106 mm	108 mm

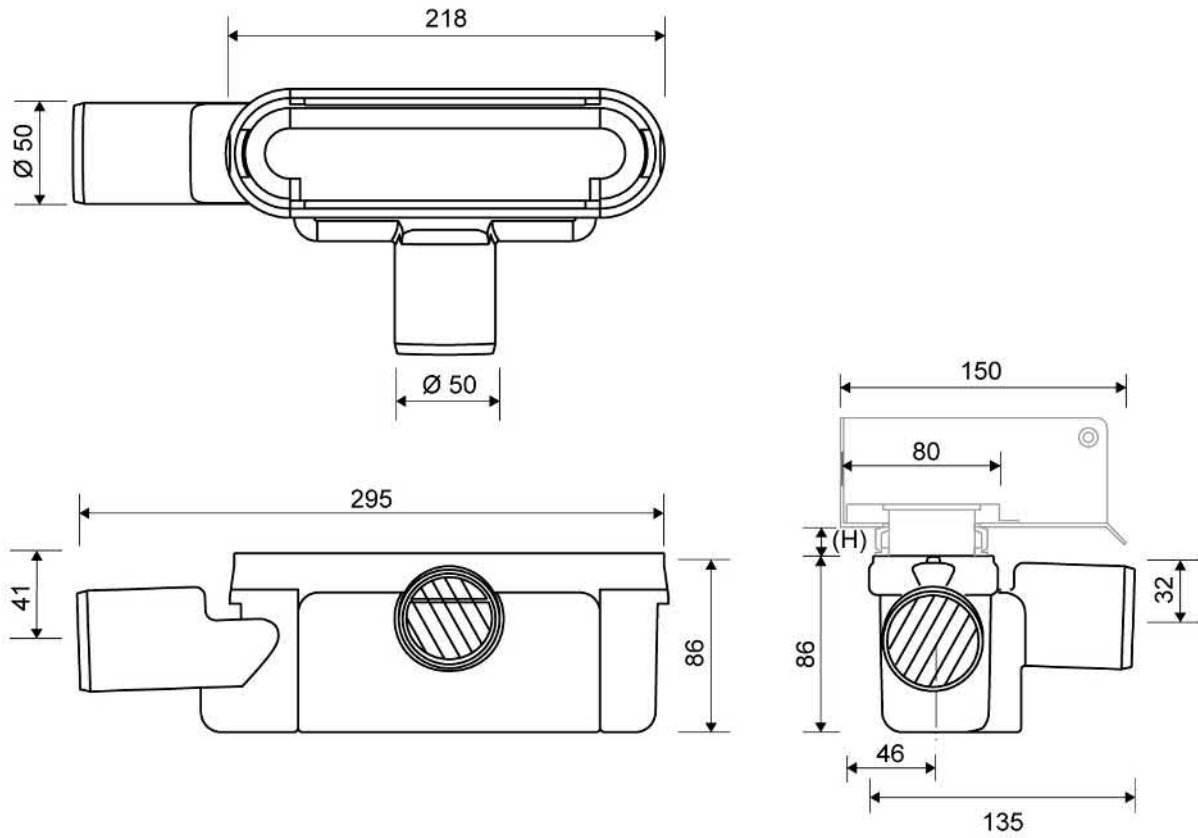

## 1950.0300 - 300 Model Custom Solution

### HighLine | Custom

The set consists of a Highline Custom base to place tile onto, heightener set and screws.  
 Tile can overhang the Highline Custom to achieve a larger visual length.  
 Consult with tile manufacturer for strength of tile and maximum overhang.  
 Must be assembled before mounting.



### Specifications

<b>ITEM NUMBER</b>	<b>GTIN NUMBER</b>	<b>WEIGHT INCLUDING PACKAGING</b>
1950.0300	5707692005324	720 g
<b>WEIGHT EXCLUDING PACKAGING</b>	<b>MATERIAL</b>	<b>USAGE</b>
660 g	Stainless steel (AISI 304)	Line drain
<b>SURFACE</b>	<b>LENGTH MODEL</b>	<b>HEIGHTENER SET</b>
Brushed	300 mm	Plastic (PE)
<b>LENGTH WITH/WITHOUT FRAME</b>		
253/315 mm		

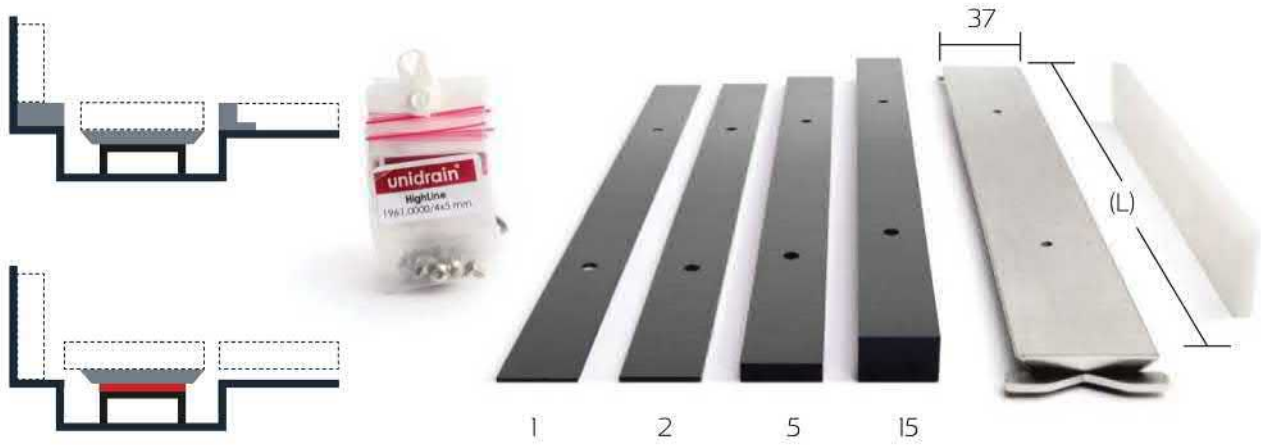

## 1K0750.1200 - 750X1200mm Board

UniSlope preformed Board with one way slope / fall built in.

To be used with Unidrain wall mounted linear drain



### Specifications

**Material:** High Density PVC Foam Board (Foamed Rigid Polyvinyl Chloride Board)

**Size with drain:** 750 x 1200mm

**Board thickness:** 23mm sloping to drain (14mm fall)

**Weight:** 7.30kg

**Density:** 50 kg/m<sup>3</sup>

**Tensile Strength:** 11MPa

**Impact Strength:** 12.8KJ/m<sup>2</sup>

**Thermal Conductivity:** 0.07 W/mK

**Temperature Range:** -10°C, +55°C

**Colour:** White

**NFPA Rating:** Health=1, Fire=0, Reactivity=0

**Hazards Identification:** No particular hazards known

**First aid measures:** In general handling the material will not cause accidents.

**Notes:** Dust masks must be worn when cutting UniSlope boards. UniSlope Boards are not load bearing and must be installed on a strong wood or concrete subfloor which is level. Follow UniSlope installation instructions.

**Refer to UniSlope kit drawings and safety data sheet for more information**



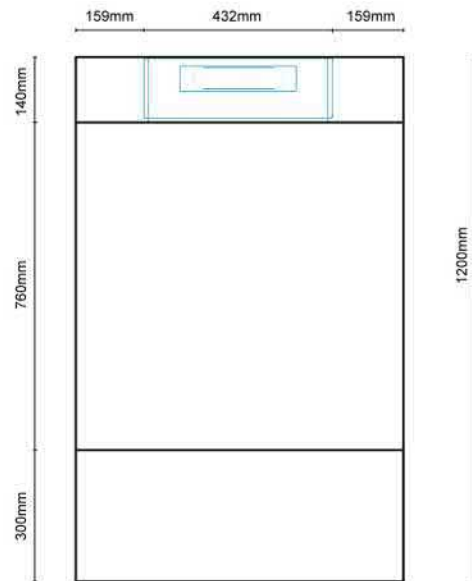
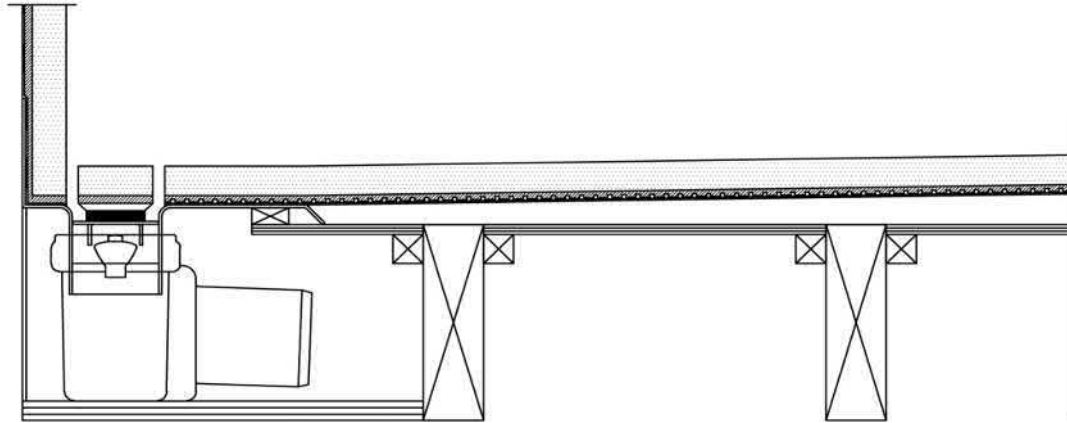

**Refer to UniSlope kit drawings and safety data sheet for more information**

## WMVS30K - Waterproofing Kit

Easy application paint on liquid membrane for waterproofing wet rooms and bathrooms

Contains 12kg liquid membrane, 25m reinforcement trap and 1l primer.



### Specifications

**Material:** acrylic polymers, plasticizer, water and preservative

**Coverage:** 7m<sup>2</sup>

**Can be applied to:** Wood, concrete, metal, plastic, plaster, light clincer concrete, screed, lightweight concrete, stucco, gypsum floors, calcium, silicate plates and various approved wet room plaster boards, gypsum fibre, cement and polystyrene.

**Drying time:** 1st layer 1-2 hours at 18-20°C. 2nd layer approx 12 hours at 18-20°C.

Drying times will vary depending on temperature, ventilation and substrate.

**Application method:** Paint brush and roller.

**Notes:** Room must be primed with Primer 54 included before applying liquid membrane. All major joints must be reinforced using LIP reinforcement tape included. Ensure all areas are dry after each stage before proceeding i.e. Priming, 1st coat and 2nd coat before proceeding. No one can access the area whilst membrane is drying. Once 2nd coat is completely dry, cover membrane with a suitable protective sheet / board until tiled. If a heater is required, do not place too close to the membrane.

**Refer to installation instructions and safety data sheet for more information.**