

1K0800.09002

kit Size 800mm x 900mm

Can be trimmed to 712mm x 500mm



KIT CONTAINS

WALL MOUNTED DRAIN
MULTI DIRECTIONAL OUTLET
HIGHLINE CUSTOM
UNISLOPE PREFORMED
BOARD
TANKING KIT

1004.0601 - 600 Model Drain Body

Line 1004

Wall Mounted Linear Drain fixed to wall for a very secure installation and to allow for a one way fall. Suitable for 25mm wall build up. For larger sizes, please contact Wet Room Materials. Can be freely positioned against rear wall, independent of any side walls.

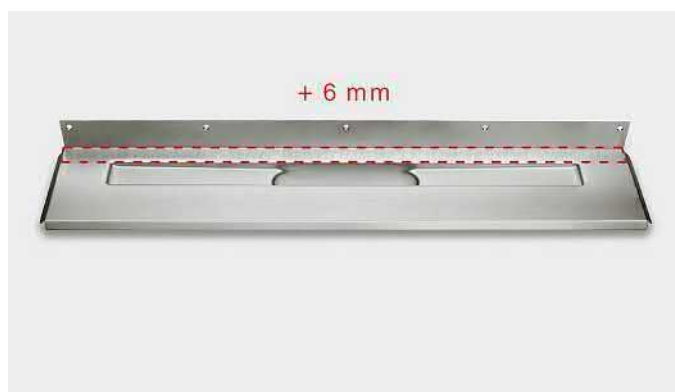

Specifications

ITEM NUMBER	GTIN NUMBER	MATERIAL
1004.0601	5707692008387	1.5 mm stainless steel (AISI 304)
USAGE	SURFACE	MEMBRANE
Linear drain	Pickled	Liquid or sheet membrane
FLOOR CONSTRUCTION	FLOORING	MOUNTING
All	Tiles	6 mm Pluks 6 mm Skruer. Torx 20
CENTER	INSTALLATION LENGTH (L)	HEIGHT (H)
356 mm	712 mm	16 mm
LENGTH MODEL		
600		

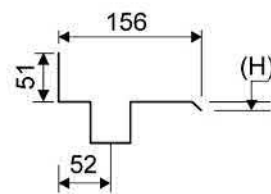
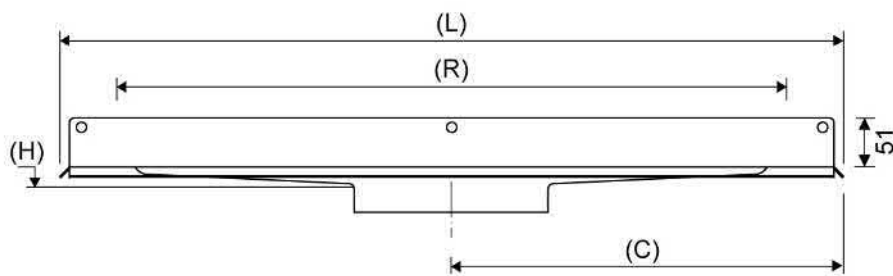
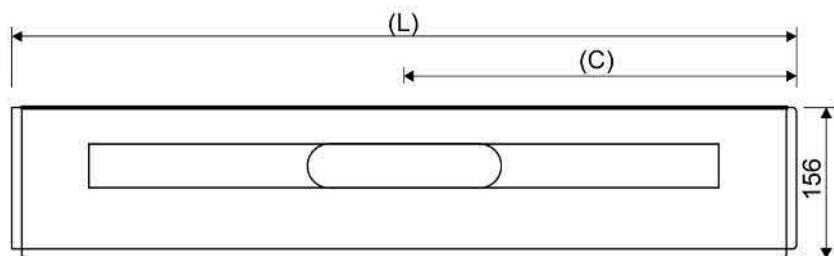

1416.0050 - Multi Directional Outlet

Line 1416.0050

Ø 50 mm horizontal drain

Can be rotated 180 degrees if a rear-facing outlet is required.

Note two drains. Cannot be used as an inlet.



Specifications

ITEM NUMBER	GTIN NUMBER	WEIGHT INCLUDING PACKAGING
1416.0050	5707692012520	505 g
WEIGHT EXCLUDING PACKAGING	MATERIAL	USAGE
312 g	Plastic (PP)	Line drain
BARRIER	GASKET	CAPACITY
With	EPDM	0,8 l/s
SIDE INLET	CENTER	FITS DRAIN UNIT
Without	32 mm	1001, 1002, 1003, 1004, 1100, 3002, 3004, 5002, 5003, 4004

FITTING HEIGHTS - LINE FAUCETS 1001, 1002, 1003, 1004

Ø	Outlet direction	300	600	700	800	900	1000	1200
Ø 50 mm	Horizontal	98 mm	102 mm	103 mm	104 mm	105 mm	106 mm	108 mm

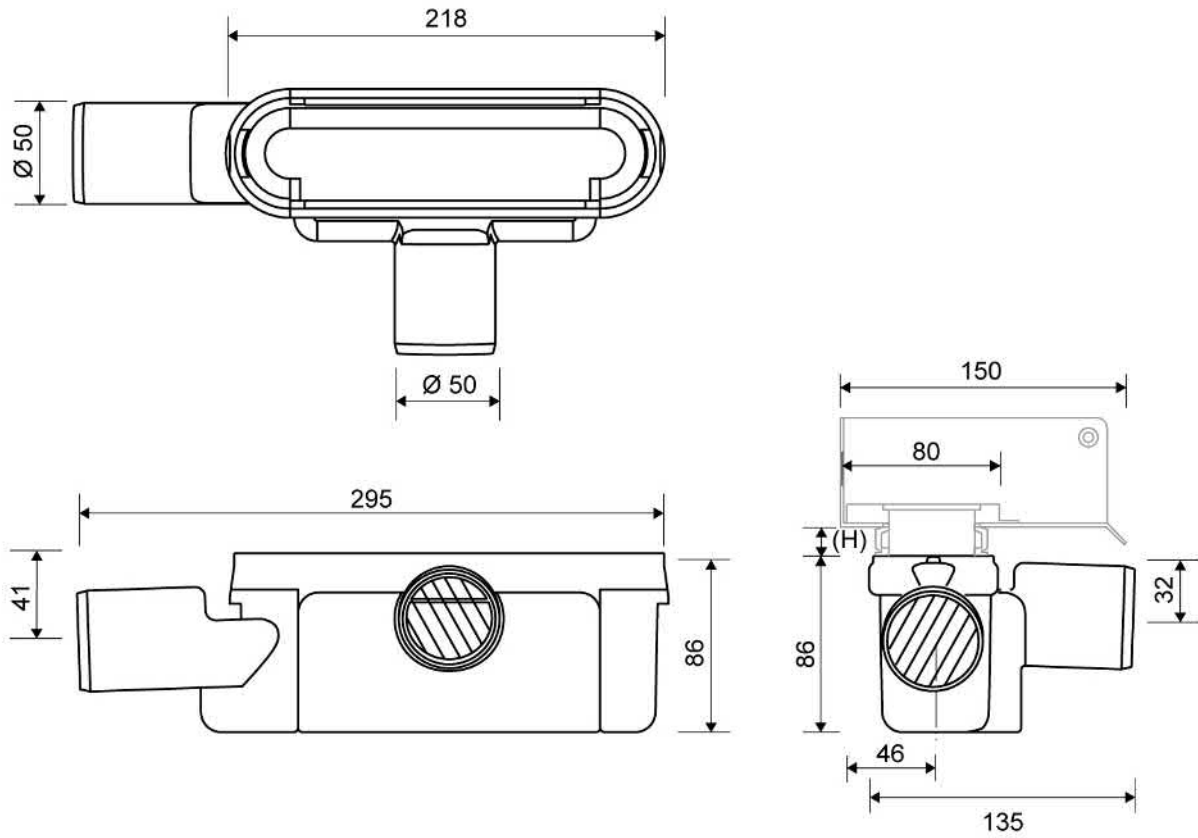

1950.0600 - 600mm Custom Solution

HighLine | Custom

The set consists of a Highline Custom base to place tile onto, heightener set and screws.
Tile can overhang the Highline Custom to achieve a larger visual length.
Consult with tile manufacturer for strength of tile and maximum overhang.
Must be assembled before mounting.



Specifications

ITEM NUMBER	WEIGHT INCLUDING PACKAGING	WEIGHT EXCLUDING PACKAGING
1950.0600	1580 g	1510 g
MATERIAL	USAGE	SURFACE
Stainless steel (AISI 304)	Line drain	Brushed
LENGTH MODEL	HEIGHTENER SET	LENGTH
600	Plastic (PE)	533

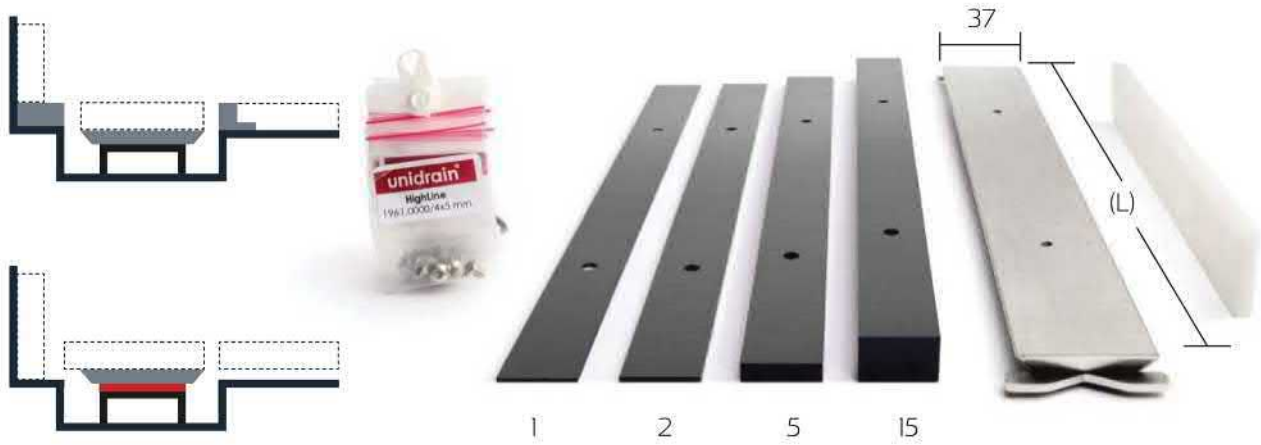

1K0800.0900 - 800X900mm Board

UniSlope preformed Board with one way slope / fall built in.

To be used with Unidrain wall mounted linear drain



Specifications

Material: High Density PVC Foam Board (Foamed Rigid Polyvinyl Chloride Board)

Size with drain: 800 x 900mm

Board thickness: 19mm sloping to drain (10mm fall)

Weight: 5kg

Density: 50 kg/m³

Tensile Strength: 11MPa

Impact Strength: 12.8KJ/m²

Thermal Conductivity: 0.07 W/mK

Temperature Range: -10°C, +55°C

Colour: White

NFPA Rating: Health=1, Fire=0, Reactivity=0

Hazards Identification: No particular hazards known

First aid measures: In general handling the material will not cause accidents.

Notes: Dust masks must be worn when cutting UniSlope boards. UniSlope Boards are not load bearing and must be installed on a strong wood or concrete subfloor which is level. Follow UniSlope installation instructions.

Refer to UniSlope kit drawings and safety data sheet for more information

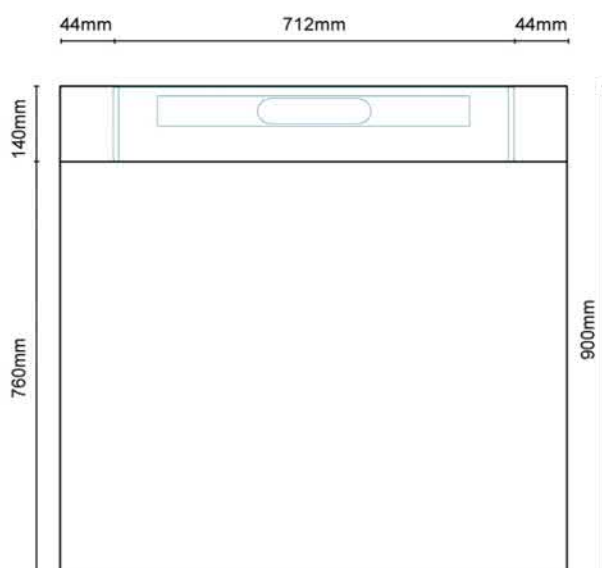
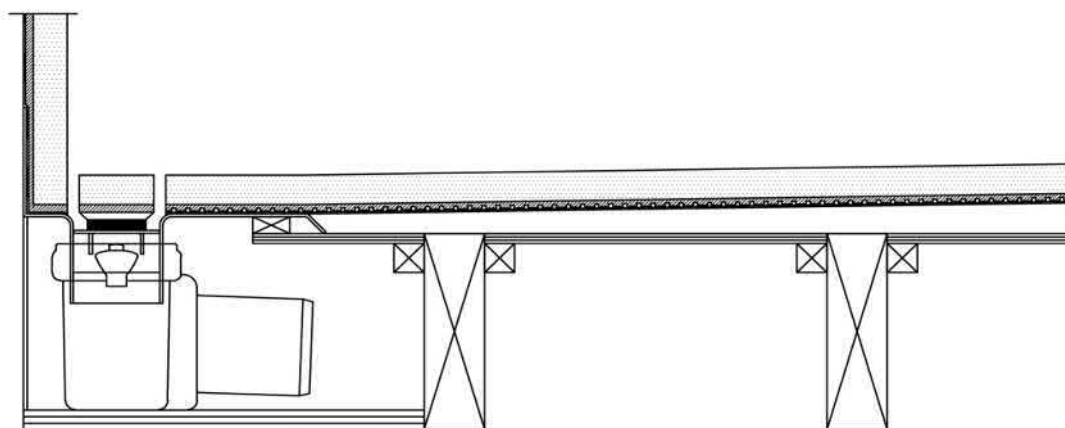

Refer to UniSlope kit drawings and safety data sheet for more information

WMVS30K - Waterproofing Kit

Easy application paint on liquid membrane for waterproofing wet rooms and bathrooms

Contains 12kg liquid membrane, 25m reinforcement trap and 1l primer.



Specifications

Material: acrylic polymers, plasticizer, water and preservative

Coverage: 7m²

Can be applied to: Wood, concrete, metal, plastic, plaster, light clincer concrete, screed, lightweight concrete, stucco, gypsum floors, calcium, silicate plates and various approved wet room plaster boards, gypsum fibre, cement and polystyrene.

Drying time: 1st layer 1-2 hours at 18-20°C. 2nd layer approx 12 hours at 18-20°C.

Drying times will vary depending on temperature, ventilation and substrate.

Application method: Paint brush and roller.

Notes: Room must be primed with Primer 54 included before applying liquid membrane. All major joints must be reinforced using LIP reinforcement tape included. Ensure all areas are dry after each stage before proceeding i.e. Priming, 1st coat and 2nd coat before proceeding. No one can access the area whilst membrane is drying. Once 2nd coat is completely dry, cover membrane with a suitable protective sheet / board until tiled. If a heater is required, do not place too close to the membrane.

Refer to installation instructions and safety data sheet for more information.