

**1K2500.09003**

Kit Size 2500mm x 900mm

Can be trimmed to 2109mm x 500mm



## KIT CONTAINS

WALL MOUNTED DRAIN  
MULTI DIRECTIONAL OUTLET  
HIGHLINE FRAME  
HIGHLINE PANEL  
UNISLOPE PREFORMED  
BOARDS  
TANKING KIT

WM | Wetroom Materials

[www.wetroommaterials.com](http://www.wetroommaterials.com) [sales@wetroommaterials.com](mailto:sales@wetroommaterials.com)

UK: Derwentside, 25 Town Street, Duffield, Belper, Derbyshire, DE56 4EH T: +44 (0) 1332 840 820  
IRE: Unit E1 Ballymount Industrial Estate, Walkinstown, Dublin 12, D12 WR60 T: +353 (0) 1 297 3488

## 1004.2001 - 2000 Model Drain Body

Line 1004

Wall Mounted Linear Drain fixed to wall for a very secure installation and to allow for a one way fall. Suitable for 25mm wall build up. For larger sizes, please contact Wet Room Materials. Can be freely positioned against rear wall, independent of any side walls.



### Specifications

|                           |                                |                                   |
|---------------------------|--------------------------------|-----------------------------------|
| <b>ITEM NUMBER</b>        | <b>GTIN NUMBER</b>             | <b>MATERIAL</b>                   |
| 1004.2001                 | 5707692008387                  | 1.5 mm stainless steel (AISI 304) |
| <b>USAGE</b>              | <b>SURFACE</b>                 | <b>MEMBRANE</b>                   |
| Linear drain              | Pickled                        | Liquid or sheet membrane          |
| <b>FLOOR CONSTRUCTION</b> | <b>FLOORING</b>                | <b>MOUNTING</b>                   |
| All                       | Tiles                          | 6 mm Pluks 6 mm Skruer. Torx 20   |
| <b>CENTER</b>             | <b>INSTALLATION LENGTH (L)</b> | <b>HEIGHT (H)</b>                 |
| 556 mm                    | 2109 mm                        | 19 mm                             |
| <b>LENGTH MODEL</b>       |                                |                                   |
| 2000                      |                                |                                   |

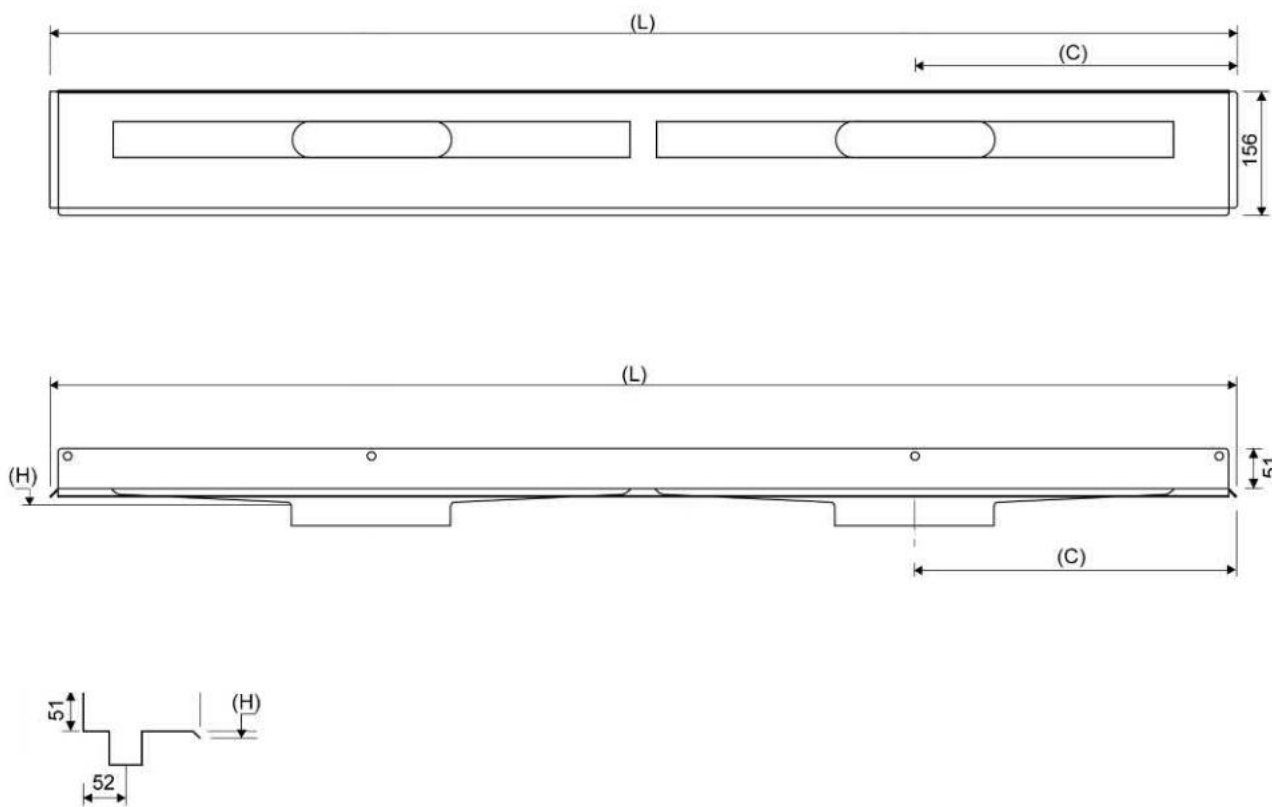

## 1416.0050 - Multi Directional Outlet

Line 1416.0050

Ø 50 mm horizontal drain

Can be rotated 180 degrees if a rear-facing outlet is required.

Note two drains. Cannot be used as an inlet.



### Specifications

|                            |               |  |
|----------------------------|---------------|--|
| ITEM NUMBER                | GTIN NUMBER   | WEIGHT INCLUDING PACKAGING                                 |
| 1416.0050                  | 5707692012520 | 505 g  |
| WEIGHT EXCLUDING PACKAGING | MATERIAL      | USAGE  |
| 312 g                      | Plastic (PP)  | Line drain   |
| BARRIER                    | GASKET        | CAPACITY   |
| With                       | EPDM          | 0,8 l/s  |
| SIDE INLET                 | CENTER        | FITS DRAIN UNIT  |
| Without                    | 32 mm         | 1001, 1002, 1003, 1004, 1100, 3002, 3004, 5002, 5003, 4004 |

FITTING HEIGHTS - LINE FAUCETS 1001, 1002, 1003, 1004

| Ø       | Outlet direction | 300   | 600    | 700    | 800    | 900    | 1000   | 1200   |
|---------|------------------|-------|--------|--------|--------|--------|--------|--------|
| Ø 50 mm | Horizontal       | 98 mm | 102 mm | 103 mm | 104 mm | 105 mm | 106 mm | 108 mm |



## 1910.1015 - 1000mm Stainless Steel Frame

Line 1910

Highline Frame can be placed around Highline Custom, Cassette and Panel.  
Also available in 10, 12 and 25mm heights (depending on the thickness of the floor tile)  
Contact Wetroom Materials for other heights.

Must be installed before tiling.



### Specifications

|                            |  |                            |
|----------------------------|--|----------------------------|
| ITEM NUMBER                | GTIN NUMBER                              | WEIGHT INCLUDING PACKAGING |
| 1910.1015                  | 5707692004402                            | 2650 g                     |
| WEIGHT EXCLUDING PACKAGING | MATERIAL                                 | USAGE                      |
| 2530 g                     | Stainless steel (AISI 304)               | Line drain                 |
| SURFACE                    | INSTALLATION LENGTH (L)                  | HEIGHT (H)                 |
| Brushed                    | 995 mm                                   | H 15 mm                    |
| LENGTH MODEL               | FITS DRAIN UNIT                          | INSERT                     |
| 1000 mm                    | 1001, 1002, 1003, 1004, 1100, 5002, 5003 | Synthetic                  |

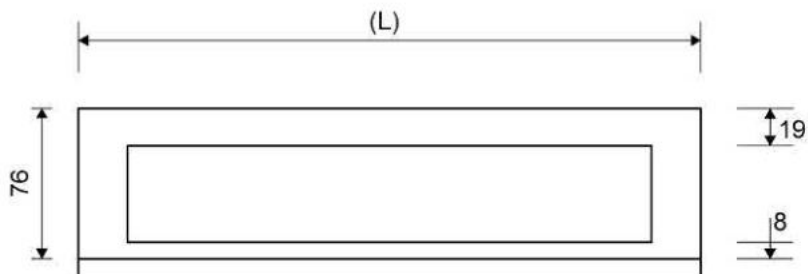

## 1920.1000 - 1000mm Panel

### HighLine | Panel

The set consists of a Highline Panel in Brushed Stainless Steel, heightener set and screws.

Can be used with or without Highline Frame.

When using without Highline Frame, ensure rear wall build up allows for equal drainage gap on all sides.

Also available in Black, Brass, Copper and Polished Stainless Steel



### Specifications

|                            |                |                            |
|----------------------------|----------------|----------------------------|
| ITEM NUMBER                | GTIN NUMBER    | WEIGHT INCLUDING PACKAGING |
| 1920.1000                  | 5707692004525  | 3100 g                     |
| MATERIAL                   | USAGE          | SURFACE                    |
| Stainless steel (AISI 304) | Line drain     | Brushed                    |
| LENGTH MODEL               | HEIGHTENER SET | LENGTH WITH/WITHOUT FRAME  |
| 1000 mm                    | Plastic (PE)   | 933/995 mm                 |



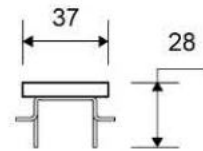
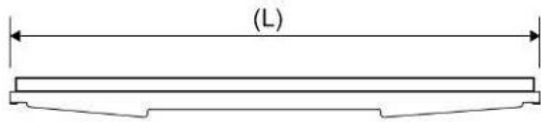
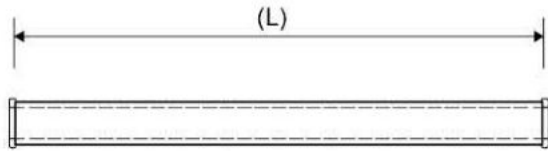

## 1K2500.0900 - 2500x900mm Board

UniSlope preformed Board with one way slope / fall built in.

To be used with Unidrain wall mounted linear drain



### Specifications

**Material:** High Density PVC Foam Board (Foamed Rigid Polyvinyl Chloride Board)

**Size with drain:** 2500 x 900mm

**Board thickness:** 19mm sloping to drain (10mm fall)

**Weight:** 13.95kg

**Density:** 50 kg/m<sup>3</sup>

**Tensile Strength:** 11MPa

**Impact Strength:** 12.8KJ/m<sup>2</sup>

**Thermal Conductivity:** 0.07 W/mK

**Temperature Range:** -10°C, +55°C

**Colour:** White

**NFPA Rating:** Health=1, Fire=0, Reactivity=0

**Hazards Identification:** No particular hazards known

**First aid measures:** In general handling the material will not cause accidents.

**Notes:** Dust masks must be worn when cutting UniSlope boards. UniSlope Boards are not load bearing and must be installed on a strong wood or concrete subfloor which is level. Follow UniSlope installation instructions.

**Refer to UniSlope kit drawings and safety data sheet for more information**

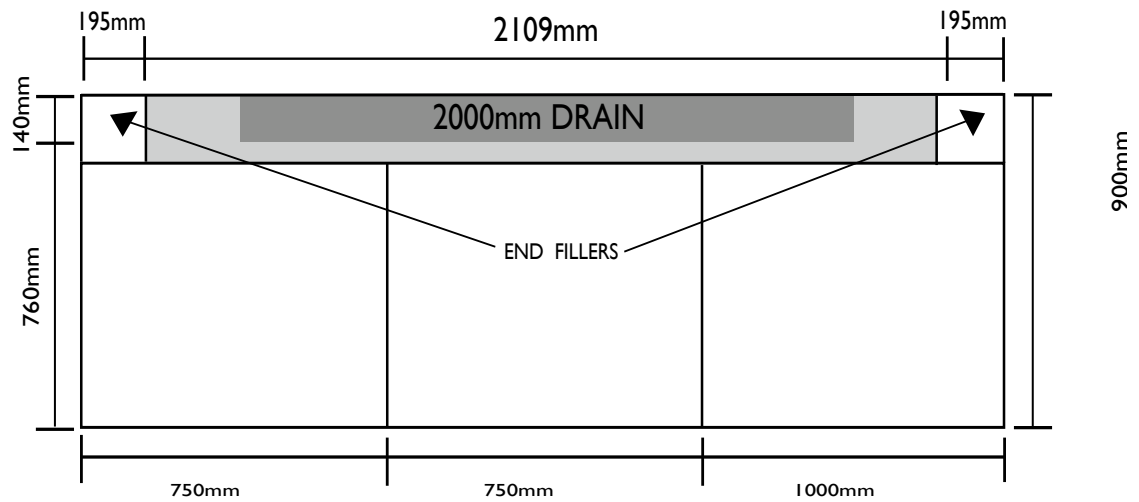
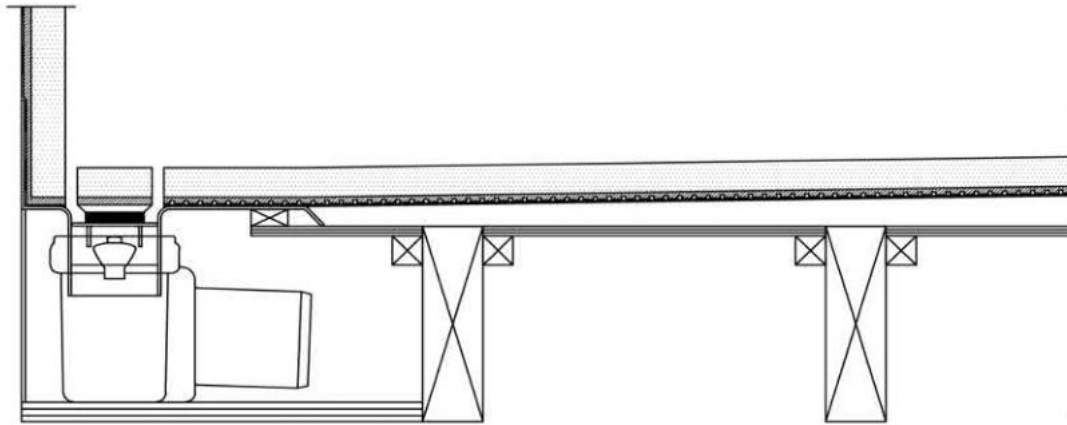

**Refer to UniSlope kit drawings and safety data sheet for more information**

## WMVS30K - Waterproofing Kit

Easy application paint on liquid membrane for waterproofing wet rooms and bathrooms

Contains 12kg liquid membrane, 25m reinforcement trap and 1l primer.



### Specifications

**Material:** acrylic polymers, plasticizer, water and preservative

**Coverage:** 12m<sup>2</sup>

**Can be applied to:** Wood, concrete, metal, plastic, plaster, light clincer concrete, screed, lightweight concrete, stucco, gypsum floors, calcium, silicate plates and various approved wet room plaster boards, gypsum fibre, cement and polystyrene.

**Drying time:** 1st layer 1-2 hours at 18-20°C. 2nd layer approx 12 hours at 18-20°C.  
Drying times will vary depending on temperature, ventilation and substrate.

**Application method:** Paint brush and roller.

**Notes:** Room must be primed with Primer 54 included before applying liquid membrane. All major joints must be reinforced using LIP reinforcement tape included. Ensure all areas are dry after each stage before proceeding i.e. Priming, 1st coat and 2nd coat before proceeding. No one can access the area whilst membrane is drying. Once 2nd coat is completely dry, cover membrane with a suitable protective sheet / board until tiled. If a heater is required, do not place too close to the membrane.

**Refer to installation instructions and safety data sheet for more information.**