

2K1500.15001MO1

Kit Size 1500mm x 1500mm - Low Profile Outlet
Can be trimmed to 1200 x 1200mm



KIT CONTAINS

WALL MOUNTED
CORNER DRAIN
LOW PROFILE OUTLET
CLASSICLINE FRAME
ANNIVERSARIO GRATE
UNISLOPE PREFORMED
BOARD
TANKING KIT

2011.0200 - 200 Model Drain Body

Corner 2011

The drain unit has two wall flanges and one floor flange.



Specifications

ITEM NUMBER	GTIN NUMBER	WEIGHT INCLUDING PACKAGING
2011.0200	5707692006659	900 g
WEIGHT EXCLUDING PACKAGING	MATERIAL	USAGE
700 g	1,5 mm stainless steel (AISI 304)	Corner drain
SURFACE	MEMBRANE	FLOOR CONSTRUCTION
Pickled	Liquid or sheet membrane	All
FLOORING	MOUNTING	INSTALLATION LENGTH (L1)
Tiles	6 mm plugs 6 mm screws. Torx 20	377 mm
INSTALLATION LENGTH (L2)		
267 mm		

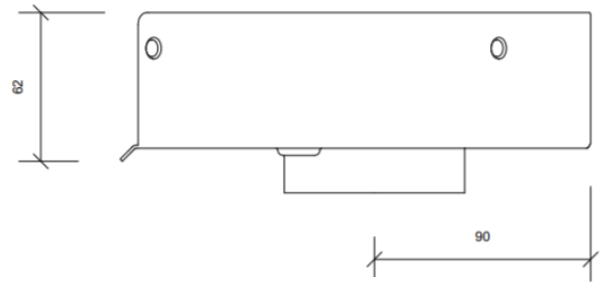
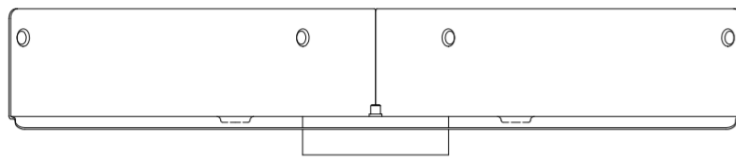
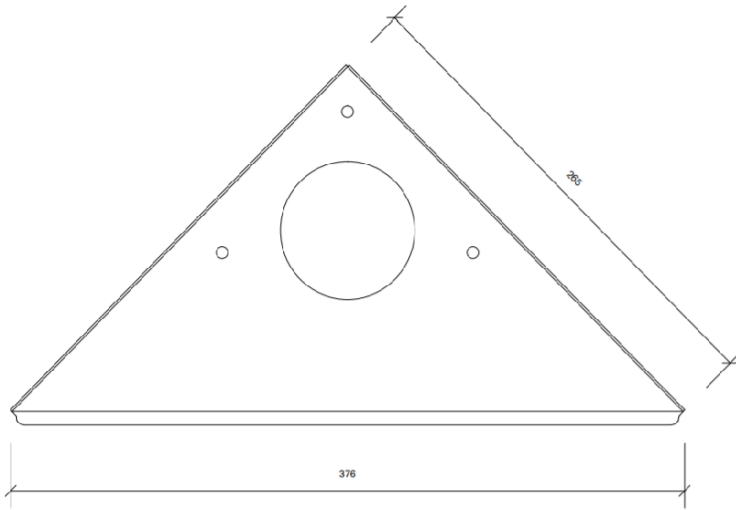

2011.0200

2415.0050 - Low Profile Outlet

Line 2415 0050

Ø 50 mm horizontal drain

With removable odour barrier with effective self-cleaning effect

The odour barrier can be removed for cleaning. Can be rotated 360 degrees to facilitate pipework positioning

Note: Odour barrier is VA-approved



Specifications

ITEM NUMBER	GTIN NUMBER	WEIGHT INCLUDING PACKAGING
2415.0050	5707692006796	450 g
WEIGHT EXCLUDING PACKAGING	MATERIAL	USAGE
350 g	Plastic PP	Corner drain
BARRIER	GASKET	CAPACITY
With (odour barrier)	EPDM	0.5 l/s
SIDE INLET	CONSTRUCTION HEIGHT (CORNER)	FITS DRAIN UNIT
Without	72 mm	2011.0200

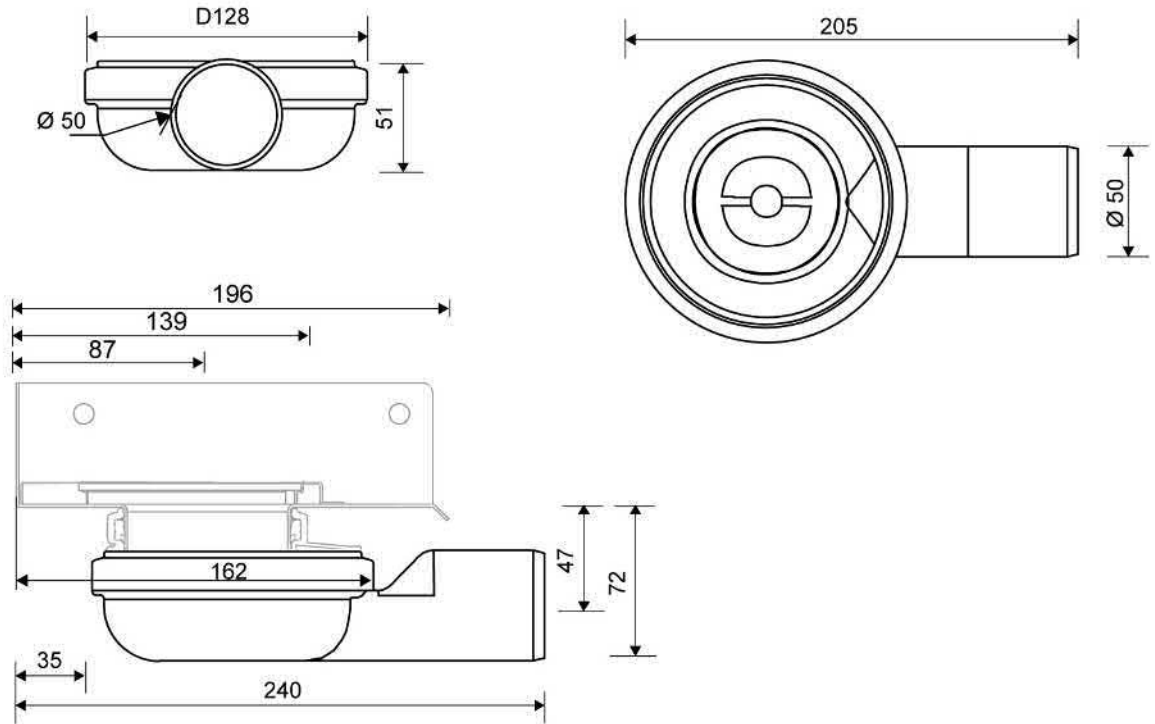

2415.0050

2501.0212 - ClassicLine Frame

Corner 2500

Available in 8, 10 and 12 mm heights (depending on the thickness of the floor tile)



Specifications

ITEM NUMBER	GTIN NUMBER	WEIGHT INCLUDING PACKAGING
2501.0212	5707692002620	310 g
WEIGHT EXCLUDING PACKAGING	MATERIAL	USAGE
240 g	Stainless steel (AISI 304)	Corner drain
SURFACE	INSTALLATION LENGTH (L)	HEIGHT (H)
Brushed	L1: 270 / L2: 193 mm	H 12 mm
LENGTH MODEL	FITS DRAIN UNIT	INSERT
200 mm	2011	Synthetic

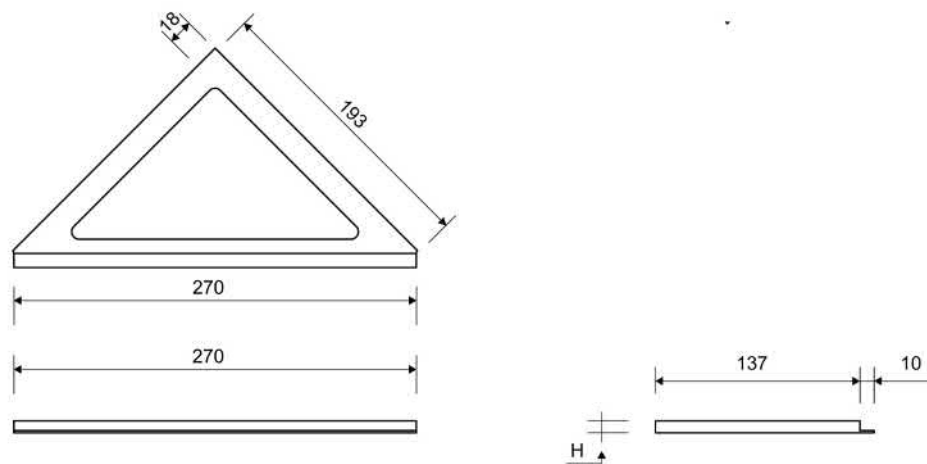

2501.0212

2603.0200 - Anniversario Grate

Corner 2600

Only for use with ClassicLine frame

To ensure a snug fit, the grating is placed on a countersunk bearing inside the frame



Specifications

ITEM NUMBER 2603.0200	GTIN NUMBER 5707692002651	WEIGHT INCLUDING PACKAGING 220 g
WEIGHT EXCLUDING PACKAGING 200 g	MATERIAL Stainless steel (AISI 304)	USAGE Corner drain
SURFACE Brushed	LENGTH MODEL 200 mm	DIMENSIONS 3 mm solid

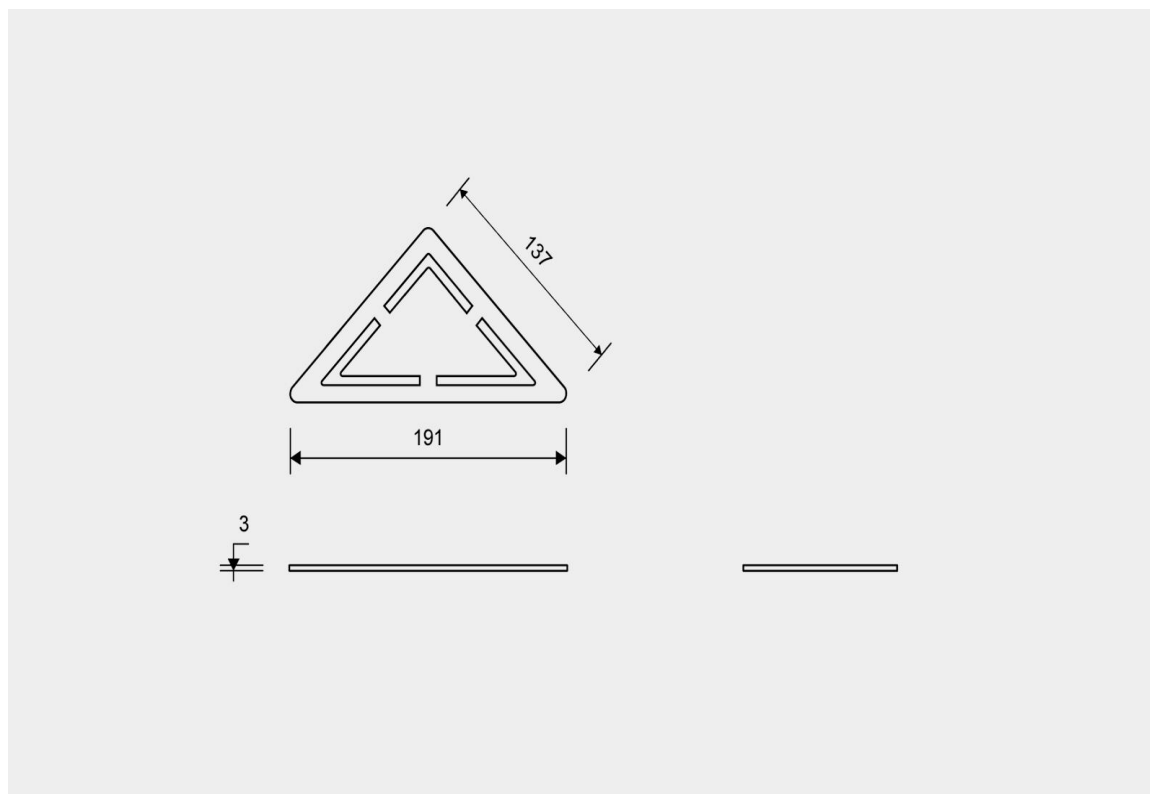

2603.0200

2K1500.1500 - 1500X1500mm Board

UniSlope preformed Board with built in slope towards the corner.

To be used with Unidrain wall mounted corner drain

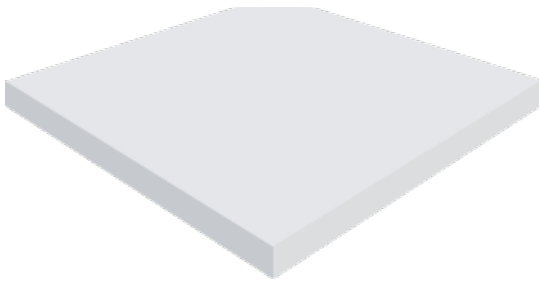

Specifications

Material: High Density PVC Foam Board (Foamed Rigid Polyvinyl Chloride Board)

Size with drain: 1500 x 1500mm

Board thickness: 28mm sloping to drain (19mm fall)

Weight: 6.2kg

Density: 50 kg/m³

Tensile Strength: 11MPa

Impact Strength: 12.8KJ/m²

Thermal Conductivity: 0.07 W/mK

Temperature Range: -10°C, +55°C

Colour: White

NFPA Rating: Health=1, Fire=0, Reactivity=0

Hazards Identification: No particular hazards known

First aid measures: In general handling the material will not cause accidents.

Notes: Dust masks must be worn when cutting UniSlope boards. UniSlope Boards are not load bearing and must be installed on a strong wood or concrete subfloor which is level. Follow UniSlope installation instructions.

Refer to UniSlope kit drawings and safety data sheet for more information

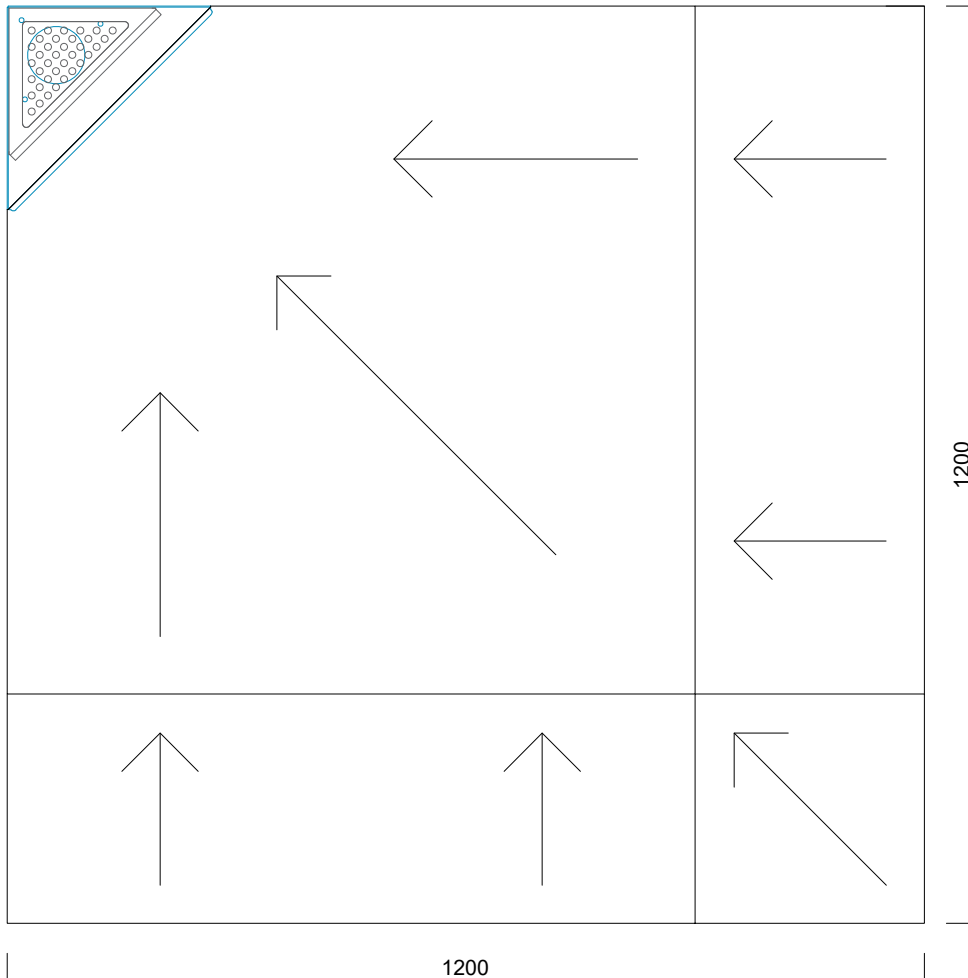
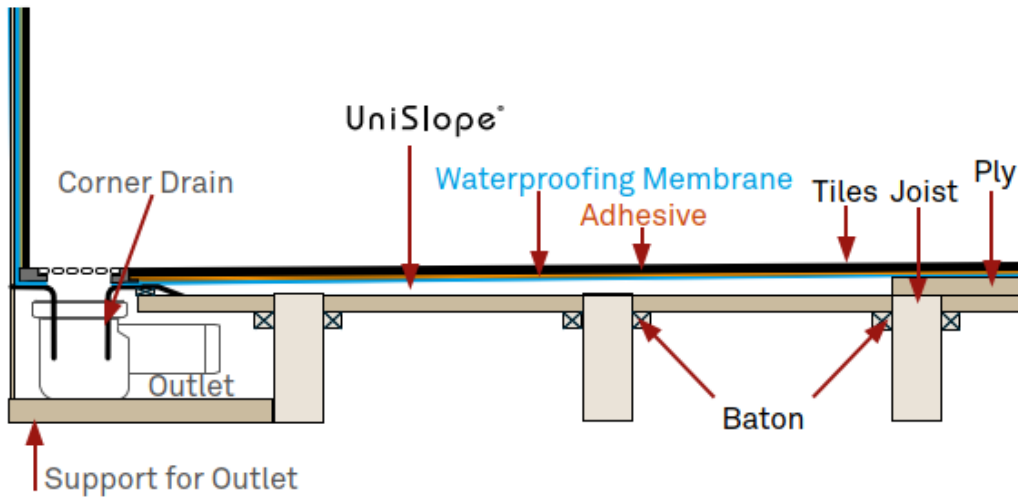

Refer to UniSlope kit drawings and safety data sheet for more information

WMVS30K - Waterproofing Kit

Easy application paint on liquid membrane for waterproofing wet rooms and bathrooms

Contains 12kg liquid membrane, 25m reinforcement trap and 1l primer.



Specifications

Material: acrylic polymers, plasticizer, water and preservative

Coverage: 12m²

Can be applied to: Wood, concrete, metal, plastic, plaster, light clincer concrete, screed, lightweight concrete, stucco, gypsum floors, calcium, silicate plates and various approved wet room plaster boards, gypsum fibre, cement and polystyrene.

Drying time: 1st layer 1-2 hours at 18-20°C. 2nd layer approx 12 hours at 18-20°C.
Drying times will vary depending on temperature, ventilation and substrate.

Application method: Paint brush and roller.

Notes: Room must be primed with Primer 54 included before applying liquid membrane. All major joints must be reinforced using LIP reinforcement tape included. Ensure all areas are dry after each stage before proceeding i.e. Priming, 1st coat and 2nd coat before proceeding. No one can access the area whilst membrane is drying. Once 2nd coat is completely dry, cover membrane with a suitable protective sheet / board until tiled. If a heater is required, do not place too close to the membrane.

Refer to installation instructions and safety data sheet for more information.