

THE PLATINUM COLLECTION
SCANDINAVIAN WETROOM SOLUTIONS





“Wetroom Materials is a company that passionately believes in the importance of providing technically, superior products supported by an unrivalled customer service”

Established in 2003, WM is a market leader in the manufacturing and distribution of Scandinavian designed wet room systems.

With a comprehensive range of award-winning EN compliant and BBA approved products, our technical service team will guide you through your wet room specification and provide you with all the components you need to create a first-class wet room with quantity guaranteed products.

We pride ourselves with our full turnkey solution from design and specification through to a no leak professional installation service.

Our hands-on approach is an intrinsic part of our DNA and sets us apart from our competitors. WM understands the importance of the supply chain and takes great pride in our added value approach from the Architect and Retailer Specification through to the final Installation

Architects

CPD Presentations
 Specification Support
 CAD files / Data Sheets
 Client Meetings
 Site Surveys
 10-year Product Warranties
 Low Profile Solutions
 BBA Approved
 Installation Service

Retailer

Easy to specify – One Kit Code
 Customer Care Line
 Technical Support
 Site Surveys
 Product Stocked Locally
 2-3-day lead time
 Site Delivery at no extra charge.
 10 Year Product Warranties
 Installation Service



CONTENTS

ABOUT US	
INSTALLATION BENEFITS	06
INSTALLATION SERVICE	08
CONSUMER BENEFITS	09
HOW TO SPECIFY YOUR WETROOM KIT	11
GALLERY	12
COMPLETE KITS	28
1 K UNISLOPE®	30
2 K UNISLOPE®	38
3 K UNISLOPE®	40
4 K UNISLOPE®	42
UNIDRAIN® GLASSLINE	44
UNIDRAIN® REFRAME	48
BESPOKE GLASS	54
UNIDRAIN®	56
BESPOKE DRAINS	60
WALL MOUNTED LINEAR DRAINS	62
CORNER DRAINS	70
CENTRE FLOOR LINEAR DRAINS	72
SQUARE DRAINS	82
VINYL DRAINS	86
UNIDRAIN® MATLINE	88
FOUNDATION MATERIALS	90
INSTALLATION / MAINTENANCE KITS	91
ACCESSORIES	92
TECHNICAL DRAWINGS	93
TECHNICAL DRAWINGS	93
DRAIN MAINBODIES	104
OUTLET OPTIONS	106
PRICELIST	107

WE OFFER AN INSTALLATION SERVICE



WATERPROOFING INSTALLATION SERVICE WITH 10 YEAR NO LEAK GUARANTEE

- We provide a 10 year no leak guarantee on all waterproofing installations.
- Experts in wet room design, specification and installation
- Our products are BBA, ETAG, EC1 Plus, CE approved and comply with building regulations
- Products are designed for wet rooms and approved by the highest construction bodies around the world
- Professional installation team specialising in wet rooms and waterproofing
- Installers have been trained to the best working Scandinavian practices
- Team arrive on site to suit your schedule and complete work in planned time frame
- Trusted by Architects, Developers, Builders and Retailers throughout the UK and Ireland
- Peace of mind with our 10 year no leak guarantee

PROFESSIONAL INSTALLATION - HIGH QUALITY MATERIALS



We only use Scandinavian products that are designed for wet rooms and have been approved by the highest construction standards in the industry. All our installers are professionals in waterproofing and have been trained and certified in Scandinavia. This not only allows us to guarantee against leaks for 10 years but also guarantees the performance and longevity of the wet room.



WE OFFER AN INSTALLATION SERVICE



OUR INSTALLATION PROCESS

1 Specification of best solution and dedicated project manager

We will assist in recommending the optimum wet room foundation products

2 Site survey

We will provide guidelines on the correct room preparation

3 Drain installation

We will fix drain to the wall

4 Slope installation

Using either our Unislope board or our specialist screed

We will create the correct slope to the drain

5 Waterproofing with 10 year no leak guarantee

Priming of areas to be waterproofed

Reinforcement of weak areas and joints

Installation of waterproofing membrane



INSTALLATION BENEFITS

COMPLETE SOLUTION

- EASY TO INSTALL
- SECURE WALL MOUNTED DRAIN
- PRESSED STAINLESS STEEL WITH NO WELDING / WEAK AREAS
- SOLID PLASTIC SLOPED BOARD
- ALL KITS CAN BE TRIMMED TO SIZE
- FULL RANGE OF INSTALLATION VIDEOS AND GUIDELINES
- OVER 20 OUTLETS TO CHOOSE FROM
- LOW BUILDING DEPTH, FROM 64mm
- DRAIN SIZES AVAILABLE FROM 300mm TO 1800mm
- APPROVED BY BBA AND OTHER ORGANISATIONS



UNIQUE FEATURES



EASY INSTALLATION PROCESS



SUITABLE FOR WOODEN AND CONCRETE FOUNDATIONS



LIGHT WEIGHT PREFORMED SLOPED BOARDS



STRONG AND FLEXIBLE WATERPROOF MEMBRANE



NO NEED TO CUT TILES TOWARDS DRAIN

CONSUMER BENEFITS

SAFE SECURE STYLISH

- NOT STANDING ON THE DRAIN IN THE SHOWER
- ONE WAY SLOPE - NO STAGNANT WATER
- DON'T HAVE TO CUT TILES - LESS GROUT
- COMPLETE WET ROOM SOLUTION
- EXTENSIVE RANGE OF SIZES
- 100% WATERPROOF
- FULL PRODUCT WARRANTY
- AWARD WINNING SCANDINAVIAN SYSTEMS



GLOBAL BRAND

LARGE RANGE OF FINISHES



SIMPLE CLEANING PROCESS



REMOVE GRATE/PANEL WITH HOOK



EASILY REMOVE TRAP FROM OUTLET



SEPARATE TRAP COMPONENTS



RINSE AND CLEAN WITH HOT WATER



NEW

ECO-FRIENDLY CLEANING KIT
Code WMMK

≡≡ RE | FRAME
collection by unidrain®



HOW TO SPECIFY YOUR WET ROOM KIT

TYPICAL BATHROOM LAYOUT / STEPS

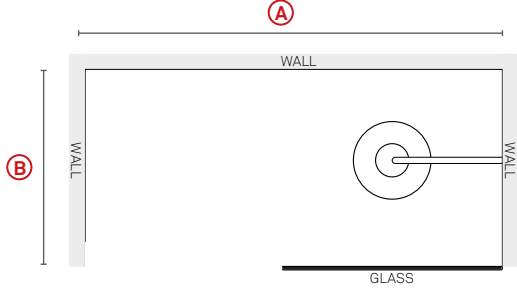

- DECIDE ON THE LOCATION OF THE DRAIN
- CHOOSE FROM ONE OF THE OPTIONS BELOW
- THEN PICK THE APPROPRIATE SIZE

OPTION 1 UNISLOPE 1K PAGE 32-36

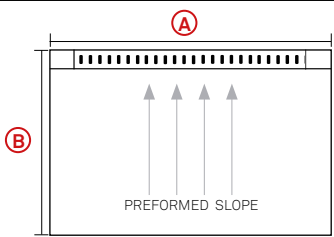

- CATCHMENT AREA FOR WATER IS GREATER.
- SLOPE LENGTH IS SHORTER.
- GLASS SITS ON A LEVEL FLOOR.
- IDEAL FOR LARGE TILES.
- NOT STANDING ON THE DRAIN IN THE SHOWER.

OPTION 2 UNISLOPE 1K PAGE 30-34

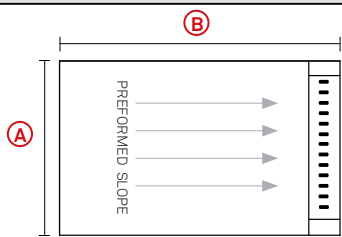

- DRAIN UNDER SHOWER HEAD.
- IDEAL FOR LARGE TILES.
- NOT STANDING ON THE DRAIN IN THE SHOWER.

OPTION 3 UNISLOPE 3K PAGE 40

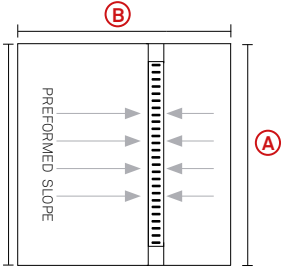

- PROVIDES TEMPLATE FOR SLOPE AND SHOWER SCREEN.
- FLEXIBILITY IN INSTALLING DRAIN, CUT BOARDS TO SUIT SECURE INSTALLATION.
- IDEAL FOR BOTH CONCRETE AND WOODEN FLOORS.

OPTION 4 UNISLOPE 4K PAGE 42

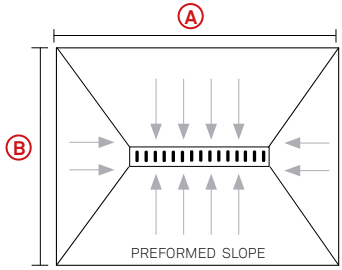

- THE PREFORMED TRAY IS LEVEL ON ALL FOUR SIDES.
- GREATER FLEXIBILITY IN PLACING THE DRAIN BETWEEN JOISTS.
- IDEAL FOR SMALL TILES.

OPTION 5 GLASSLINE PAGE 44



- SECURE INSTALLATION BETWEEN THE FLOOR, WALLS AND GLASS.
- DRAIN UNDER SHOWER HEAD.
- PROVIDES TEMPLATE FOR SLOPE AND SHOWER SCREEN.
- NOT STANDING ON THE DRAIN IN THE SHOWER.

OPTION 6 UNISLOPE 2K PAGE 38

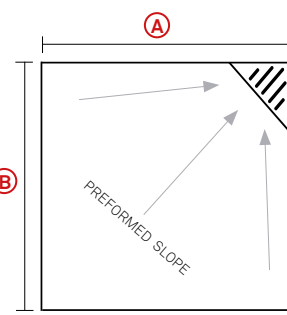

- DRAIN IN CORNER.
- IDEAL FOR SMALL TILES.
- PREFORMED TRAY IS LEVEL ON OUTER EDGE.
- NOT STANDING ON THE DRAIN IN THE SHOWER.





























THE NEW REFRAME COLLECTION BY UNIDRAIN® IS AN EXCLUSIVE AND UNIQUE SERIES OF BATHROOM ACCESSORIES GROUNDED IN SCANDINAVIAN DESIGN AND QUALITY.

The inspiration for the collection comes from lines, and each product is designed with innovative, unique and intelligent features to improve functionality. The Reframe collection is reframing the existing, bringing new functionality into bathroom accessories. Five different colour options give you the possibility of matching all metal details, conveying a subtle feeling of luxury. Choose between brushed or polished steel, brass, copper and black.



≡≡≡ RE | FRAME
collection by unidrain



OVERVIEW

UniSlope® COMPLETE KITS

APPROVED FOR WOODEN AND CONCRETE FLOOR CONSTRUCTION

ALL KITS INCLUDE

- A DRAIN
- PREFORMED SLOPE BOARD
- 8m² WATERPROOFING SYSTEM



UNISLOPE®

1K

RANGE

PAGE 28

LINEAR DRAIN WALL MOUNTED

- Avoid standing on the drain whilst showering.
- Ideal for large tiles. Less grout lines.
- Secure installation with wall mounted drain.
- One way slope.
- Level floor access is easily achieved.

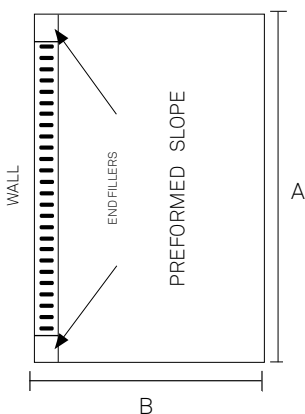

UNISLOPE®

2K

RANGE

PAGE 34

CORNER WALL MOUNTED

- Wall mounted drain in the corner.
- Ideal for small tiles.
- Preformed tray is level on outer edge.
- Avoid standing on the drain whilst showering.

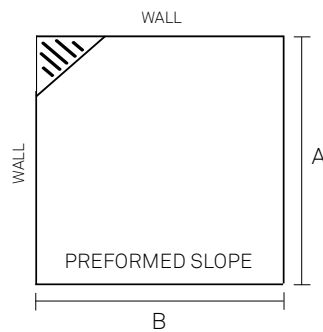



UNISLOPE®
3K

RANGE

PAGE 36

FREE PLACEMENT LINEAR DRAIN

- Greater flexibility in placing the drain between joists.
- Ideal for large and small tiles.
- Option to place drain in numerous places and cut board to suit.

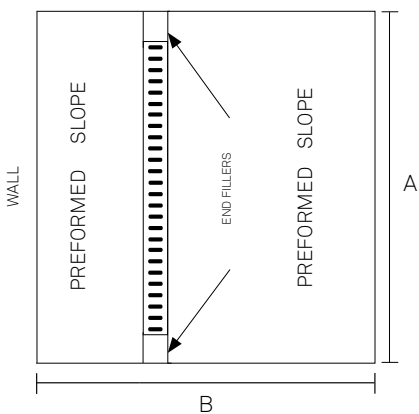

UNISLOPE®
4K

RANGE

PAGE 38

CENTRE FLOOR LINEAR DRAIN

- The preformed tray is level on all four sides.
- Greater flexibility in placing the drain between joists.
- Ideal for small tiles.

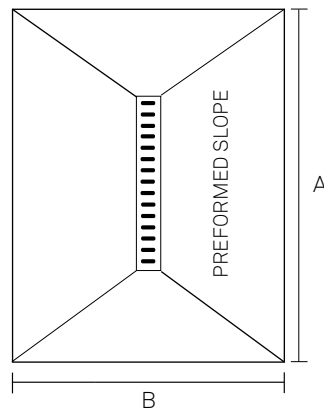

UniSlope® | 1 K

ALL KITS INCLUDE

- A DRAIN
- PREFORMED SLOPE BOARD
- 8m² WATERPROOFING SYSTEM



Wall Mounted Drain

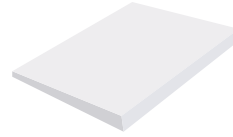

Preformed Slope



Waterproofing kit

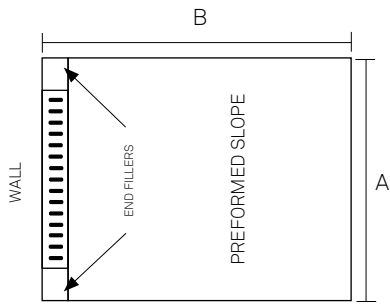

DESIGN OPTIONS



Size A B	Minimum Size	Board Height	Drain Model	Anniversario Grate Kit Order Ref	HighLine Custom Kit Order Ref	HighLine Panel Brushed Stainless Steel Kit Order Ref	HighLine Cassette Kit Order Ref
750 x 900	432 x 500	19	300	1K0750.09001	1K0750.09002	1K0750.09003	1K0750.09004
750 x 1200	432 x 900	23	300	1K0750.12001	1K0750.12002	1K0750.12003	1K0750.12004
750 x 1660	432 x 1200	30	300	1K0750.16601	1K0750.16602	1K0750.16603	1K0750.16604
800 x 900	712 x 500	19	600	1K0800.09001	1K0800.09002	N/A	N/A
800 x 1200	712 x 900	23	600	1K0800.12001	1K0800.12002	N/A	N/A
800 x 1660	712 x 1200	30	600	1K0800.16601	1K0800.16602	N/A	N/A
900 x 900	812 x 500	19	700	1K0900.09001	1K0900.09002	1K0900.09003	1K0900.09004
900 x 1200	812 x 900	23	700	1K0900.12001	1K0900.12002	1K0900.12003	1K0900.12004
900 x 1660	812 x 1200	30	700	1K0900.16601	1K0900.16602	1K0900.16603	1K0900.16604
1000 x 900	912 x 500	19	800	1K1000.09001	1K1000.09002	1K1000.09003	1K1000.09004
1000 x 1200	912 x 900	23	800	1K1000.12001	1K1000.12002	1K1000.12003	1K1000.12004
1000 x 1660	912 x 1200	30	800	1K1000.16601	1K1000.16602	1K1000.16603	1K1000.16604
1200 x 900	1012 x 500	19	900	1K1200.09001	1K1200.09002	1K1200.09003	1K1200.09004
1200 x 1200	1012 x 900	23	900	1K1200.12001	1K1200.12002	1K1200.12003	1K1200.12004
1200 x 1660	1012 x 1200	30	900	1K1200.16601	1K1200.16602	1K1200.16603	1K1200.16604



Linear Drain Strainer
Order Ref
WM1810.0010
Page 92



Hook
Order Ref
WM1840.0000
Page 92



Maintenance Kit
Order Ref
WMMK
Page 91



Installation Kit
Order Ref
WMIKU
Page 91



Tanking Kit
Order Ref
WMVS30K
Page 90



UniSlope® | 1 K

ALL KITS INCLUDE

- A DRAIN
- PREFORMED SLOPE BOARD
- 8m² WATERPROOFING SYSTEM



Wall Mounted Drain

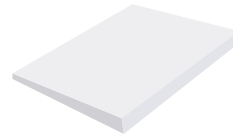

Preformed Slope



Waterproofing kit

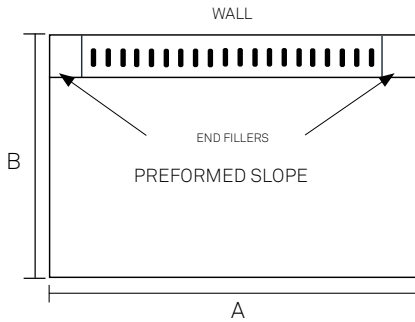

DESIGN OPTIONS



Size A B	Minimum Size	Board Height	Drain Model	Anniversario Grate Kit Order Ref	HighLine Custom Kit Order Ref	HighLine Panel Brushed Stainless Steel Kit Order Ref	HighLine Cassette Kit Order Ref
1500 x 900	1112 x 500	19	1000	1K1500.09001	1K1500.09002	1K1500.09003	1K1500.09004
1500 x 1200	1112 x 900	23	1000	1K1500.12001	1K1500.12002	1K1500.12003	1K1500.12004
1500 x 1660	1112 x 1200	30	1000	1K1500.16601	1K1500.16602	1K1500.16603	1K1500.16604
1650 x 900	1312 x 500	19	1200	1K1650.09001	1K1650.09002	1K1650.09003	1K1650.09004
1650 x 1200	1312 x 900	23	1200	1K1650.12001	1K1650.12002	1K1650.12003	1K1650.12004
1650 x 1660	1312 x 1200	30	1200	1K1650.16601	1K1650.16602	1K1650.16603	1K1650.16604
1800 x 900	1509 x 500	19	1400	1K1800.09001	1K1800.09002	1K1800.09003	1K1800.09004
1800 x 1200	1509 x 900	23	1400	1K1800.12001	1K1800.12002	1K1800.12003	1K1800.12004
1800 x 1660	1509 x 1200	30	1400	1K1800.16601	1K1800.16602	1K1800.16603	1K1800.16604
2000 x 900	1709 x 500	19	1600	1K2000.09001	1K2000.09002	1K2000.09003	1K2000.09004
2000 x 1200	1709 x 900	23	1600	1K2000.12001	1K2000.12002	1K2000.12003	1K2000.12004
2000 x 1660	1709 x 1200	30	1600	1K2000.16601	1K2000.16602	1K2000.16603	1K2000.16604
2250 x 900	1909 x 500	19	1800	1K2250.09001	1K2250.09002	1K2250.09003	1K2250.09004
2250 x 1200	1909 x 900	23	1800	1K2250.12001	1K2250.12002	1K2250.12003	1K2250.12004
2250 x 1660	1909 x 1200	30	1800	1K2250.16601	1K2250.16602	1K2250.16603	1K2250.16604



Linear Drain Strainer
Order Ref
WM1810.0010
Page 92



Hook
Order Ref
WM1840.0000
Page 92



Maintenance Kit
Order Ref
WMMK
Page 91



Installation Kit
Order Ref
WMIKU
Page 91



Tanking Kit
Order Ref
WMVS30K
Page 90



UniSlope® | 1K ELEGANCE

ALL KITS INCLUDE

- A DRAIN
- PVD DURABLE COATING
- PREFORMED SLOPE BOARD
- 8m² WATERPROOFING SYSTEM



Wall Mounted Drain

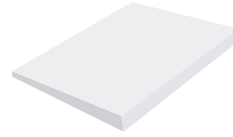

Preformed Slope



Waterproofing kit

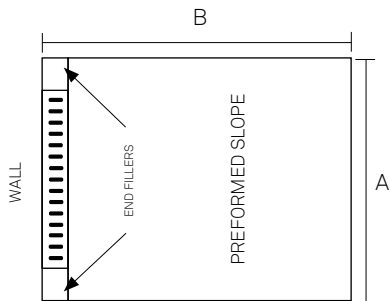

DESIGN OPTION WITHOUT FRAME



Size A B	Minimum Size	Board Height	Drain Model	HighLine Panel Brass Kit Order Ref	HighLine Panel Copper Kit Order Ref	HighLine Panel Black Kit Order Ref	HighLine Panel Polished Stainless Steel Kit Order Ref
750 x 900	432 x 500	19	300	1K0750.09005NF	1K0750.09006NF	1K0750.09007NF	1K0750.09008NF
750 x 1200	432 x 900	23	300	1K0750.12005NF	1K0750.12006NF	1K0750.12007NF	1K0750.12008NF
750 x 1660	432 x 1200	30	300	1K0750.16605NF	1K0750.16606NF	1K0750.16607NF	1K0750.16608NF
900 x 900	812 x 500	19	700	1K0900.09005NF	1K0900.09006NF	1K0900.09007NF	1K0900.09008NF
900 x 1200	812 x 900	23	700	1K0900.12005NF	1K0900.12006NF	1K0900.12007NF	1K0900.12008NF
900 x 1660	812 x 1200	30	700	1K0900.16605NF	1K0900.16606NF	1K0900.16607NF	1K0900.16608NF
1000 x 900	912 x 500	19	800	1K1000.09005NF	1K1000.09006NF	1K1000.09007NF	1K1000.09008NF
1000 x 1200	912 x 900	23	800	1K1000.12005NF	1K1000.12006NF	1K1000.12007NF	1K1000.12008NF
1000 x 1660	912 x 1200	30	800	1K1000.16605NF	1K1000.16606NF	1K1000.16607NF	1K1000.16608NF
1200 x 900	1012 x 500	19	900	1K1200.09005NF	1K1200.09006NF	1K1200.09007NF	1K1200.09008NF
1200 x 1200	1012 x 900	23	900	1K1200.12005NF	1K1200.12006NF	1K1200.12007NF	1K1200.12008NF
1200 x 1660	1012 x 1200	30	900	1K1200.16605NF	1K1200.16606NF	1K1200.16607NF	1K1200.16608NF



Linear Drain Strainer
Order Ref
WM1810.0010
Page 92



Hook
Order Ref
WM1840.0000
Page 92



Maintenance Kit
Order Ref
WMMK
Page 91



Installation Kit
Order Ref
WMIKU
Page 91



Tanking Kit
Order Ref
WMVS30K
Page 90



HighLine | Panel | Polished Stainless Steel | No Frame

UniSlope® | 1K ELEGANCE

ALL KITS INCLUDE

- A DRAIN
- PVD DURABLE COATING
- PREFORMED SLOPE BOARD
- 8m² WATERPROOFING SYSTEM



Wall Mounted Drain

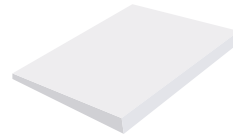

Preformed Slope



Waterproofing kit

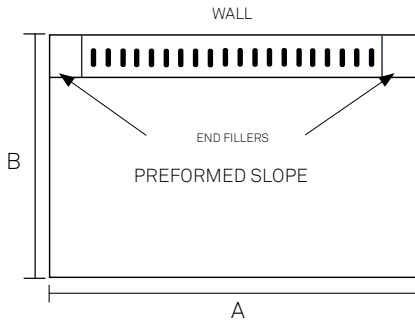

DESIGN OPTION WITHOUT FRAME



Size A B	Minimum Size	Board Height	Drain Model	HighLine Panel Brass Kit Order Ref	HighLine Panel Copper Kit Order Ref	HighLine Panel Black Kit Order Ref	HighLine Panel Polished Stainless Steel Kit Order Ref
1500 x 900	1112 x 500	19	1000	1K1500.09005NF	1K1500.09006NF	1K1500.09007NF	1K1500.09008NF
1500 x 1200	1112 x 900	23	1000	1K1500.12005NF	1K1500.12006NF	1K1500.12007NF	1K1500.12008NF
1500 x 1660	1112 x 1200	30	1000	1K1500.16605NF	1K1500.16606NF	1K1500.16607NF	1K1500.16608NF
1650 x 900	1312 x 500	19	1200	1K1650.09005NF	1K1650.09006NF	1K1650.09007NF	1K1650.09008NF
1650 x 1200	1312 x 900	23	1200	1K1650.12005NF	1K1650.12006NF	1K1650.12007NF	1K1650.12008NF
1650 x 1660	1312 x 1200	30	1200	1K1650.16605NF	1K1650.16606NF	1K1650.16607NF	1K1650.16608NF
1800 x 900	1509 x 500	19	1400	1K1800.09005NF	1K1800.09006NF	1K1800.09007NF	1K1800.09008NF
1800 x 1200	1509 x 900	23	1400	1K1800.12005NF	1K1800.12006NF	1K1800.12007NF	1K1800.12008NF
1800 x 1660	1509 x 1200	30	1400	1K1800.16605NF	1K1800.16606NF	1K1800.16607NF	1K1800.16608NF
2000 x 900	1709 x 500	19	1600	1K2000.09005NF	1K2000.09006NF	1K2000.09007NF	1K2000.09008NF
2000 x 1200	1709 x 900	23	1600	1K2000.12005NF	1K2000.12006NF	1K2000.12007NF	1K2000.12008NF
2000 x 1660	1709 x 1200	30	1600	1K2000.16605NF	1K2000.16606NF	1K2000.16607NF	1K2000.16608NF
2250 x 900	1909 x 500	19	1800	1K2250.09005NF	1K2250.09006NF	1K2250.09007NF	1K2250.09008NF
2250 x 1200	1909 x 900	23	1800	1K2250.12005NF	1K2250.12006NF	1K2250.12007NF	1K2250.12008NF
2250 x 1660	1909 x 1200	30	1800	1K2250.16605NF	1K2250.16606NF	1K2250.16607NF	1K2250.16608NF



Linear Drain Strainer
Order Ref
WM1810.0010
Page 92



Hook
Order Ref
WM1840.0000
Page 92



Maintenance Kit
Order Ref
WMMK
Page 91



Installation Kit
Order Ref
WMIKU
Page 91



Tanking Kit
Order Ref
WMVS30K
Page 90



UniSlope® | 2K

ALL KITS INCLUDE

- A DRAIN
- PVD DURABLE COATING
- PREFORMED SLOPE BOARD
- 8m² WATERPROOFING SYSTEM



Corner Drain



Preformed Slope



Waterproofing kit

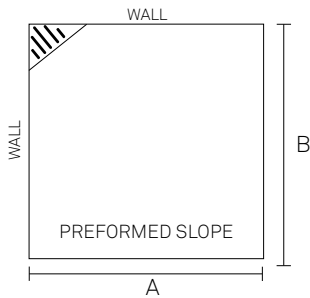

DESIGN OPTIONS



Size A B	Minimum Size	Board Height	Drain Model	Classic Grate Kit Order Ref	Column Kit Order Ref	Brushed Stainless Steel Kit Order Ref
900 x 900	500 x 500	19	Corner Drain	2K0900.09001	2K0900.09011	2K0900.09003

OTHER DESIGN OPTIONS AVAILABLE

Price subject to minimum order quantity



Black



Brass



Copper



Polished



Corner Drain Strainer
Order Ref
WM2811.0010
Page 92



Hook
Order Ref
WM1840.0000
Page 92



Maintenance Kit
Order Ref
WMMK
Page 91



Installation Kit
Order Ref
WMIKU
Page 91



Tanking Kit
Order Ref
WMVS30K
Page 90



UniSlope® | 3K

ALL KITS INCLUDE

- A DRAIN
- PVD DURABLE COATING
- PREFORMED SLOPE BOARD
- 8m² WATERPROOFING SYSTEM



Centre Drain

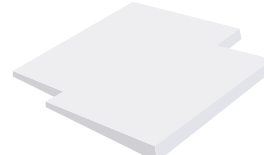

Preformed Slope



Waterproofing kit

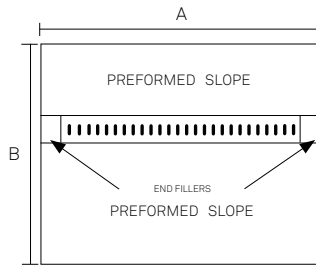

DESIGN OPTIONS



Size A B	Minimum Size	Board Height	Drain Model	Anniversario Grate Kit Order Ref	HighLine Custom Kit Order Ref	HighLine Panel Brushed Stainless Steel Kit Order Ref	HighLine Cassette Kit Order Ref
1000 x 1728	812 x 500	19	700	3K1000.17281	3K1000.17282	3K1000.17283	3K1000.17284
1000 x 2028	812 x 1728	23	700	3K1000.20281	3K1000.20282	3K1000.20283	3K1000.20284
1000 x 2488	812 x 2028	30	700	3K1000.24881	3K1000.24882	3K1000.24883	3K1000.24884
1500 x 1728	1312 x 500	19	1200	3K1500.17281	3K1500.17282	3K1500.17283	3K1500.17284
1500 x 2028	1312 x 1728	23	1200	3K1500.20281	3K1500.20282	3K1500.20283	3K1500.20284
1500 x 2488	1312 x 2028	30	1200	3K1500.24881	3K1500.24882	3K1500.24883	3K1500.24884

DESIGN OPTION WITHOUT FRAME



Size A B	Minimum Size	Board Height	Drain Model	HighLine Panel Brass Kit Order Ref	HighLine Panel Copper Kit Order Ref	HighLine Panel Black Kit Order Ref	HighLine Polished Stainless Steel Kit Order Ref
1000 x 1728	812 x 500	19	700	3K1000.17285NF	3K1000.17286NF	3K1000.17287NF	3K1000.17288NF
1000 x 2028	812 x 1728	23	700	3K1000.20285NF	3K1000.20286NF	3K1000.20287NF	3K1000.20288NF
1000 x 2488	812 x 2028	30	700	3K1000.24885NF	3K1000.24886NF	3K1000.24887NF	3K1000.24888NF
1500 x 1728	1312 x 500	19	1200	3K1500.17285NF	3K1500.17286NF	3K1500.17287NF	3K1500.17288NF
1500 x 2028	1312 x 1728	23	1200	3K1500.20285NF	3K1500.20286NF	3K1500.20287NF	3K1500.20288NF
1500 x 2488	1312 x 2028	30	1200	3K1500.24885NF	3K1500.24886NF	3K1500.24887NF	3K1500.24888NF



Linear Drain Strainer
Order Ref
WM1810.0010
Page 92



Hook
Order Ref
WM1840.0000
Page 92



Maintenance Kit
Order Ref
WMMK
Page 91



Installation Kit
Order Ref
WMIKU
Page 91



Tanking Kit
Order Ref
WMVS30K
Page 90



UniSlope® | 4K

ALL KITS INCLUDE

- A DRAIN
- PVD DURABLE COATING
- PREFORMED SLOPE BOARD
- 8m² WATERPROOFING SYSTEM



Centre Drain



Preformed Slope



Waterproofing kit

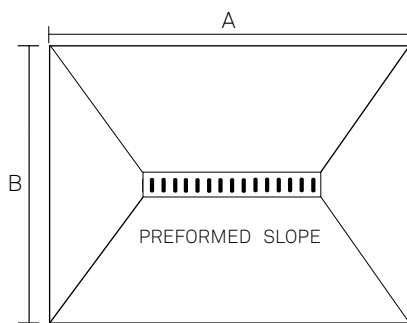

DESIGN OPTIONS



Size A B	Minimum Size	Board Thickness	Drain Model	Anniversario Grate Kit Order Ref	HighLine Custom Kit Order Ref	HighLine Panel Brushed Stainless Steel Kit Order Ref	HighLine Cassette Kit Order Ref
900 x 900	600 x 600	19	300	4K0900.09001	4K0900.09002	4K0900.09003	4K0900.09004
1200 x 900	900 x 600	19	700	4K1200.09001	4K1200.09002	4K1200.09003	4K1200.09004
1500 x 1000	1200 x 600	19	700	4K1500.10001	4K1500.10002	4K1500.10003	4K1500.10004

DESIGN OPTION WITHOUT FRAME



Size A B	Minimum Size	Board Height	Drain Model	HighLine Panel Brass Kit Order Ref	HighLine Panel Copper Kit Order Ref	HighLine Panel Black Kit Order Ref	HighLine Polished Stainless Steel Kit Order Ref
900 x 900	600 x 600	19	300	4K0900.09005NF	4K0900.09006NF	4K0900.09007NF	4K0900.09008NF
1200 x 900	900 x 600	19	700	4K1200.09005NF	4K1200.09006NF	4K1200.09007NF	4K1200.09008NF
1500 x 1000	1200 x 600	19	700	4K1500.10005NF	4K1500.10006NF	4K1500.10007NF	4K1500.10008NF



Linear Drain Strainer
Order Ref
WM1810.0010
Page 92



Hook
Order Ref
WM1840.0000
Page 92



Maintenance Kit
Order Ref
WMMK
Page 91



Installation Kit
Order Ref
WMIKU
Page 91



Tanking Kit
Order Ref
WMVS30K
Page 90



UNIDRAIN GLASSLINE

WALL MOUNTED DRAIN
WITH INTEGRATED SLOPE
AND SHOWER SCREEN

THE GLASSLINE RANGE PROVIDES AN INTEGRATED SOLUTION FOR THE WALL MOUNTED DRAIN, SLOPE AND GLASS SCREEN. ALSO PROVIDING A WATER TIGHT SOLUTION BETWEEN THE WALLS AND FLOOR.

BENEFITS

- Stylish bright look
- Drain and rail system is wall mounted for easy installation
- 100% watertight solution as glass screen is integrated into the drain
- Level floor access is achievable
- Removable grate/tile for easy cleaning
- No need to stand on the drain while showering as the drain is positioned against the wall



UNIDRIAN GLASSLINE

AN INTEGRATED SOLUTION FOR THE WALL MOUNTED DRAIN , SLOPE AND GLASS SCREEN AS WELL AS PROVIDING A WATER TIGHT SOLUTION BETWEEN THE WALLS AND FLOOR.



Shower screen

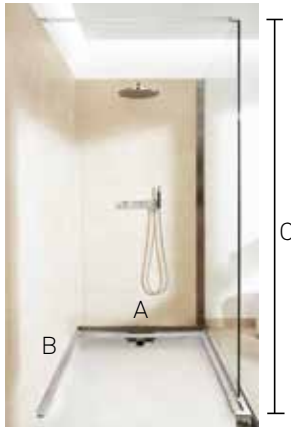





DESIGN OPTIONS



A Drain Size	B Shower Screen	C Shower Screen Height	Drain Depth	Anniversario Grate Kit Order Ref	HighLine Custom Kit Order Ref	Brushed Stainless Steel HighLine Panel Kit Order Ref	HighLine Cassette Kit Order Ref
800	800	2104	104	5000.0808K1	5000.0808K2	5000.0808K3	5000.0808K4
800	900	2104	104	5000.0809K1	5000.0809K2	5000.0809K3	5000.0809K4
800	1000	2104	104	5000.0810K1	5000.0810K2	5000.0810K3	5000.0810K4
800	1200	2104	104	5000.0812K1	5000.0812K2	5000.0812K3	5000.0812K4
900	800	2104	104	5000.0908K1	5000.0908K2	5000.0908K3	5000.0908K4
900	900	2104	105	5000.0909K1	5000.0909K2	5000.0909K3	5000.0909K4
900	1000	2104	105	5000.0910K1	5000.0910K2	5000.0910K3	5000.0910K4
900	1200	2104	105	5000.0912K1	5000.0912K2	5000.0912K3	5000.0912K4
1000	900	2104	107	5000.1009K1	5000.1009K2	5000.1009K3	5000.1009K4
1000	1000	2104	107	5000.1010K1	5000.1010K2	5000.1010K3	5000.1010K4
1000	1200	2104	107	5000.1012K1	5000.1012K2	5000.1012K3	5000.1012K4

Glass can be hung on the right or left. Please place **L** or **R** after the order ref to indicate location of glass.

- 
 Linear Drain Strainer
 Order Ref
WM1810.0010
 Page 92
- 
 Hook
 Order Ref
WM1840.0000
 Page 92
- 
 Maintenance Kit
 Order Ref
WMMK
 Page 91
- 
 Installation Kit
 Order Ref
WMIKU
 Page 91
- 
 Tanking Kit
 Order Ref
WMVS30K
 Page 90

UNIDRIAN GLASSLINE ACCESSORIES

GLASS DOOR

Made from 8mm safety glass and treated with Cleantec Nanotechnology. Supplied with two hinges and a seal strip. It must be used with a bracing bar.

Model No.	Width	Height	Glass Door Order ref
800	776	2023	5400.0800
900	876	2023	5400.0900
1000	976	2023	5400.1000



GLASS BRACING BAR

Made from 10mm safety glass. Must be used with glass screens lengths that are 1200mm or more.

Model No.	Right Bar Order Ref	Left Bar Order Ref
700	5320.1702	5320.1703
800	5320.1802	5320.1803
900	5320.1902	5320.1903
1000	5320.1002	5320.1003
1200	5320.1202	5320.1203



METAL BRACING BAR

Made from brushed stainless steel. Must be used with glass screens that are 1200mm or more.

Model No.	Right Bar Order Ref	Left Bar Order Ref
700	5310.1202	5310.1203
800	5310.1202	5310.1203
900	5310.1202	5310.1203
1000	5310.1202	5310.1203
1200	5310.1202	5310.1203





RE | FRAME

collection by unidrain®

UNIDRAIN'S NEW ACCESSORY COLLECTION FITS THE EXISTING PRODUCT PORTFOLIO SHOWING A TIMELESS AND MINIMALISTIC DESIGN WITH INNOVATIVE, UNIQUE AND INTELLIGENT FEATURES. THE COLLECTION GIVES THE OPPORTUNITY TO MATCH ALL METAL DETAILS IN THE BATHROOM.

Each product possesses its own unique features which have been designed to improve the functionality of the product. Each product in the collection comes in brushed and polished stainless steel and also with a brass, copper and black finish. All products are featuring the unidrain logo and are inspired by lines and Scandinavian design.



REFRAME

collection by unidrain®

OVERVIEW

The new Reframe Collection by Unidrain is an exclusive and unique series of bathroom accessories grounded in Scandinavian design and quality. Each product is designed with innovative, unique and intelligent features to improve functionality. Reframe is available in five different colours.



1 SHOWER SHELF AND SHOWER WIPER

Unique soap shelf with hidden magnets in the wall fitting to give your shower wiper a permanent, functional and practical home.



2 CORNER SOAP SHELF

Streamline soap shelf which is designed to be installed in the corner of a shower.



3 SHOWER WIPER

Shower wiper with magnetic wall mounted bracket.



4 TOWEL BAR

The towel bar blends perfectly with the rest of the collection and ensures that your towels hang perfectly.



5 TOWEL HOOKS

Two elegant and stylish hooks to hold your towels or robes firmly in place.



6 TOILET BRUSH WALLMOUNTED

Position anywhere on the wall to make cleaning your bathroom easier.



7 TOILET BRUSH FLOOR STANDING

Developed with hygiene in mind. The inner container has a splash guard to ensure no bacteria can get under the cover.



8 TOILET PAPER HOLDER

The toilet paper is held in place by a magnetic removable part to optimise friction so the paper rolls off perfectly and is easy to replace.



9 SPARE TOILET PAPER HOLDER

The extra holder has a separate rubber element to prevent the paper roll from slipping to the side and will always stay centred.

COLOUR OPTIONS



Brushed steel



Polished steel



Brass











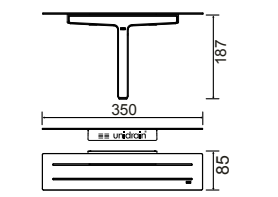

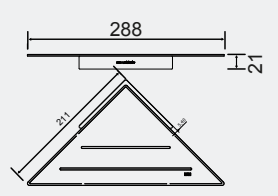
Copper

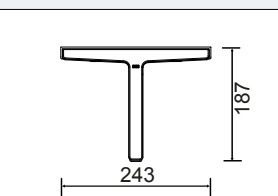
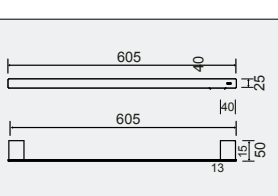

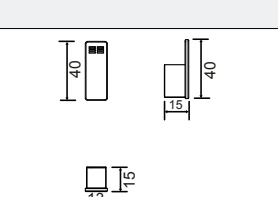
Black

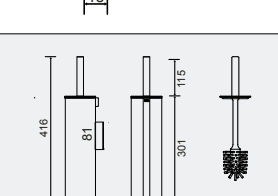
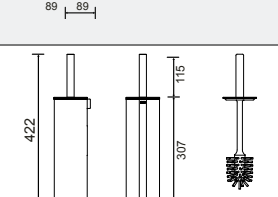
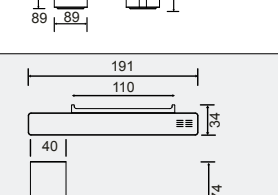

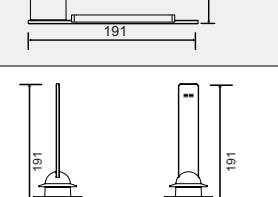
	Product		Colour Options	Order Ref
	<p>1</p> <p>Shower shelf and shower wiper</p>		<p>Brushed steel</p> <p>Polished steel</p> <p>Brass</p> <p>Copper</p> <p>Black</p>	<p>WM7010</p> <p>WM7011</p> <p>WM7012</p> <p>WM7013</p> <p>WM7014</p>
	<p>2</p> <p>Corner soap shelf</p>		<p>Brushed steel</p> <p>Polished steel</p> <p>Brass</p> <p>Copper</p> <p>Black</p>	<p>WM7210</p> <p>WM7211</p> <p>WM7212</p> <p>WM7213</p> <p>WM7214</p>
	<p>3</p> <p>Wiper</p>		<p>Brushed steel</p> <p>Polished steel</p> <p>Brass</p> <p>Copper</p> <p>Black</p>	<p>WM7030</p> <p>WM7031</p> <p>WM7032</p> <p>WM7033</p> <p>WM7034</p>
	<p>4</p> <p>Towel bar</p>		<p>Brushed steel</p> <p>Polished steel</p> <p>Brass</p> <p>Copper</p> <p>Black</p>	<p>WM7080</p> <p>WM7081</p> <p>WM7082</p> <p>WM7083</p> <p>WM7084</p>
	<p>5</p> <p>Towel hooks (2 pcs)</p>		<p>Brushed steel</p> <p>Polished steel</p> <p>Brass</p> <p>Copper</p> <p>Black</p>	<p>WM7070</p> <p>WM7071</p> <p>WM7072</p> <p>WM7073</p> <p>WM7074</p>
	<p>6</p> <p>Toilet brush, wall mounted</p>		<p>Brushed steel</p> <p>Polished steel</p> <p>Brass</p> <p>Copper</p> <p>Black</p>	<p>WM7045</p> <p>WM7046</p> <p>WM7047</p> <p>WM7048</p> <p>WM7049</p>
	<p>7</p> <p>Toilet brush, floor</p>		<p>Brushed steel</p> <p>Polished steel</p> <p>Brass</p> <p>Copper</p> <p>Black</p>	<p>WM7040</p> <p>WM7041</p> <p>WM7042</p> <p>WM7043</p> <p>WM7044</p>
	<p>8</p> <p>Toilet paper holder</p>		<p>Brushed steel</p> <p>Polished steel</p> <p>Brass</p> <p>Copper</p> <p>Black</p>	<p>WM7050</p> <p>WM7051</p> <p>WM7052</p> <p>WM7053</p> <p>WM7054</p>
	<p>9</p> <p>Spare toilet paper holder</p>		<p>Brushed steel</p> <p>Polished steel</p> <p>Brass</p> <p>Copper</p> <p>Black</p>	<p>WM7060</p> <p>WM7061</p> <p>WM7062</p> <p>WM7063</p> <p>WM7064</p>



BESPOKE GLASS SERVICES

MADE TO MEASURE GLASS SCREENS

OUR BESPOKE GLASS SCREEN SERVICE WILL PROVIDE YOU WITH THE EXPERTISE AND CONFIDENCE TO TRANSFORM YOUR SHOWER AREA. PROVIDE US WITH THE DIMENSIONS AND SPECIFICATION YOU REQUIRE AND WE WILL DO THE REST.

BENEFITS

- Wide range of hinges, handle and bracing bar
- Stay clear technology / Easy Clean
- Lifetime guarantee





UNIQUE SCANDINAVIAN WET ROOM SOLUTIONS

THE SCANDINAVIAN HERITAGE IS DEEPLY ROOTED IN THE FUNCTIONALITY AND DESIGN OF THE UNIDRAIN PRODUCTS. NORDIC, MINIMALISTIC, SUSTAINABLE AND TIMELESS SOLUTIONS OF A VERY HIGH QUALITY.

DANISH ARCHITECT CLAUS DYRE INVENTED THE LINEAR DRAIN IN 2003. UNIDRAIN'S UNIQUE FLOOR DRAIN SYSTEM WAS THE FIRST LINEAR DRAIN IN THE WORLD TO BE SAFELY PLACED AGAINST THE WALL.

BACK THEN, HIGH-END FLOOR DRAIN DESIGN WAS A NEW AND REVOLUTIONARY CONCEPT. IN JUST A FEW YEARS, UNIDRAIN® DEVELOPED INTO ONE OF THE LEADING FLOOR DRAIN MANUFACTURERS. TEN YEARS LATER, UNIDRAIN® HAS WON MANY INTERNATIONAL DESIGN AWARDS AND ARE REPRESENTED IN OVER 30 COUNTRIES AROUND THE WORLD.

The construction industry has fought for many years to keep the bathroom 100% waterproof. Unidrain solved the problem with the invention of the linear drain. The patented vertical keeps the shower area waterproof and safe. Unidrain is tested and approved for internal fitting with all types of floor structures.

Unidrain's floor drains are composed of drain unit, outlet unit, frame and grating/panel. The drains are available in both linear and corner solutions.

unidrain® GlassLine is a range of shower screens designed as a natural extension of the original unidrain® floor drain. Using a unique flange system, the shower screen is simply and securely installed in the floor and wall which represents a complete concept together with the unidrain® floor drain.

unidrain®'s patented flange system is extended to the installation of the shower screen, making Glassline the safest wet room installation / system in the marketplace.



VA 2.42/19872



DIN 4109

SIA 181

EN 1253

VDI 4100





OVERVIEW

UNIDRAIN® SOLUTIONS

LINEAR

WALL MOUNTED

CENTRE FLOOR

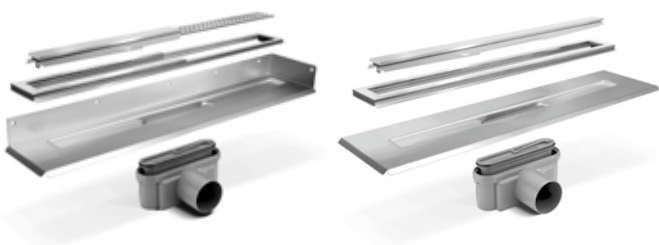

HIGHLINE



CUSTOM

PANEL

CASSETTE



BLACK

BRASS

COPPER

POLISHED STEEL

CLASSICLINE



CLASSIC

COLUMN

INCA



SQUARE

STRIPE

ANNIVERSARIO

CORNER



HIGHLINE

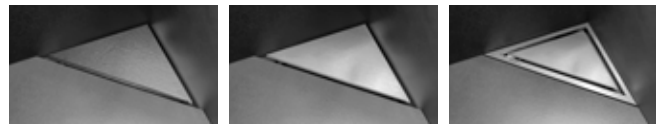

CUSTOM

PANEL WITHOUT FRAME

PANEL WITH FRAME



BLACK

BRASS

COPPER

POLISHED STEEL

CLASSICLINE



CLASSIC

COLUMN

ANNIVERSARIO

SQUARE



HIGHLINE



CUSTOM 150 X 150

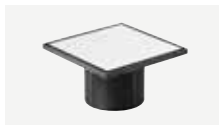

CUSTOM 100 X 100



CLASSICLINE

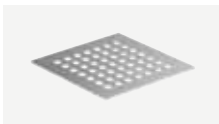

CLASSIC 150 X 150

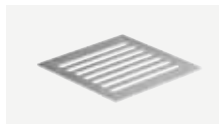

COLUMN 150 X 150

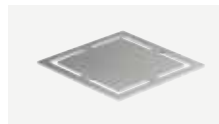

ANNIVERSARIO 150 X 150

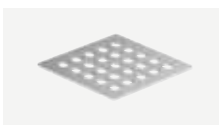

CLASSIC 100 X 100



COLUMN 100 X 100

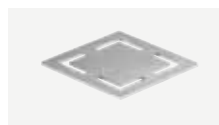

ANNIVERSARIO 100 X 100

VINYL



CLASSICLINE



COLUMN

UNIDRAIN® BESPOKE

WE OFFER A BESPOKE RANGE OF MODULAR DRAINS THAT ARE CUSTOM MADE TO ANY SIZE. SIMPLY SUPPLY US WITH THE DIMENSIONS OF YOUR WET ROOM AND WE WILL MANUFACTURE TO YOUR REQUIREMENTS.





WALL MOUNTED UNIDRAIN®

CLASSICLINE

THE WALL MOUNTED DRAIN ALLOWS YOU TO HAVE ONE SLOPE, MAKING IT IDEAL FOR LARGE TILES IF YOU WISH AND YOU NO LONGER HAVE TO STAND ON THE DRAIN IN THE SHOWER.

BENEFITS

- Classicline 12mm frame and grate in a brushed stainless steel finish.
- 54ltrs of water per minute per outlet.
- Easy to clean by removing grate and trap.
- Main drain body pressed from 1.5mm stainless steel.
- Stable and safe with large metal surface flanges for secure waterproofing.
- Internal channel within the drain to prevent stagnant water.
- Approved for wooden and concrete construction.
- No sharp edges.
- BBA approved.



Model No.	A Structural Length	B Visual Length	C Drain Depth	Kit Order Ref	Dimensions
300	432	300	98	1004.0300K1	
600	712	600	102	1004.0600K1	
700	812	700	103	1004.0700K1	
800	912	800	104	1004.0800K1	
900	1012	900	105	1004.0900K1	
1000	1112	1000	106	1004.1000K1	
1200	1312	1200	107	1004.1200K1	
1400	1509	1400	103	1004.1400K1	
1600	1709	1600	104	1004.1600K1	
1800	1909	1800	105	1004.1800K1	

CHOOSE YOUR GRATE STYLE

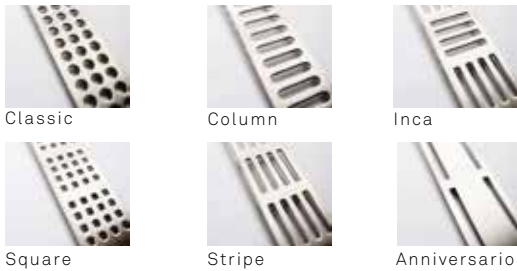

Linear Drain Strainer
Order Ref
WM1810.0010
Page 92



Hook
Order Ref
WM1840.0000
Page 92



Maintenance Kit
Order Ref
WMMK
Page 91



Installation Kit
Order Ref
WMIKU
Page 91



Tanking Kit
Order Ref
WMVS30K
Page 90



WALL MOUNTED UNIDRAIN®

HIGHLINE CUSTOM

THE WALL MOUNTED DRAIN ALLOWS YOU TO HAVE ONE SLOPE, USE LARGE TILES IF YOU WISH AND YOU NO LONGER HAVE TO STAND ON THE DRAIN IN THE SHOWER. THIS RANGE ALLOWS YOU TO TILE INTO YOUR DRAIN AND MAKE THE DRAIN COMPLETELY INVISIBLE. PERFECT FOR STONE AND PORCELAIN TILES. THIS RANGE COMES WITH ALL THE COMPONENTS BELOW.

BENEFITS

- 54ltrs of water per minute per outlet.
- Easy to clean by removing cover and trap.
- Main drain body pressed from 1.5mm stainless steel.
- Stable and safe with large metal surface flanges for secure waterproofing.
- Internal channel within the drain to prevent stagnant water.
- Approved for wooden and concrete construction.
- No sharp edges.
- BBA approved.



Model No.	A Structural Length	B Visual Length	C Drain Depth	Kit Order Ref	Dimensions
300	432	253	98	1004.0300K2	
600	712	533	102	1004.0600K2	
700	812	633	103	1004.0700K2	
800	912	733	104	1004.0800K2	
900	1012	833	105	1004.0900K2	
1000	1112	933	106	1004.1000K2	
1200	1312	1133	108	1004.1200K2	
1400	1509	633x2	103	1004.1400K2	
1600	1709	733x2	104	1004.1600K2	
1800	1909	833x2	105	1004.1800K2	



Linear Drain Strainer
Order Ref
WM1810.0010
Page 92



Hook
Order Ref
WM1840.0000
Page 92



Maintenance Kit
Order Ref
WMMK
Page 91



Installation Kit
Order Ref
WMIKU
Page 91



Tanking Kit
Order Ref
WMVS30K
Page 90



WALL MOUNTED UNIDRAIN®

HIGHLINE PANEL

THE WALL MOUNTED DRAIN ALLOWS YOU TO HAVE ONE SLOPE DOWN TO THE DRAIN. YOU NO LONGER HAVE TO STAND ON THE DRAIN WHILST SHOWERING. IT'S IDEAL FOR LARGE FORMAT TILES, STONE AND POURED FLOORS.

BENEFITS

- Solid stainless steel panel with frame in a range of different finishes.
- PVD Durable Coating.
- 54ltrs of water per minute per outlet.
- Easy to clean by removing panel and trap.
- Main drain body pressed from 1.5mm stainless steel.
- Stable and safe with large metal surface flanges for secure waterproofing.
- Internal channel within the drain to prevent stagnant water.
- Approved for wooden and concrete construction.
- BBA approved.

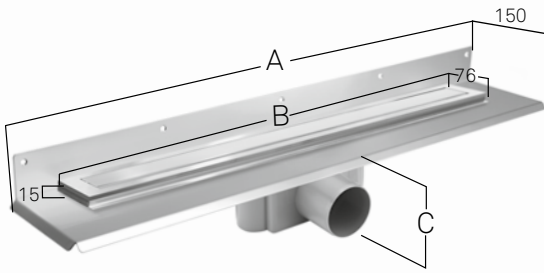

DESIGN OPTIONS

WITH FRAME



Model No.	A Structural Length	B Visual Length	C Drain Depth	Brushed Stainless Steel Kit Order Ref	Panel Brass Kit Order Ref	Panel Copper Kit Order Ref	Panel Black Kit Order Ref	Polished Stainless Steel Kit Order Ref
300	432	300	98	1004.0300K3	1004.0300K5	1004.0300K6	1004.0300K7	1004.0300K8
600	712	600	102	NA	NA	NA	NA	NA
700	812	700	103	1004.0700K3	1004.0700K5	1004.0700K6	1004.0700K7	1004.0700K8
800	912	800	104	1004.0800K3	1004.0800K5	1004.0800K6	1004.0800K7	1004.0800K8
900	1012	900	105	1004.0900K3	1004.0900K5	1004.0900K6	1004.0900K7	1004.0900K8
1000	1112	1000	106	1004.1000K3	1004.1000K5	1004.1000K6	1004.1000K7	1004.1000K8
1200	1312	1200	108	1004.1200K3	1004.1200K5	1004.1200K6	1004.1200K7	1004.1200K8
1400	1509	1400	103	1004.1400K3	1004.1400K5	1004.1400K6	1004.1400K7	1004.1400K8
1600	1709	1600	104	1004.1600K3	1004.1600K5	1004.1600K6	1004.1600K7	1004.1600K8
1800	1909	1800	105	1004.1800K3	1004.1800K5	1004.1800K6	1004.1800K7	1004.1800K8



Linear Drain Strainer
Order Ref
WM1810.0010
Page 92



Hook
Order Ref
WM1840.0000
Page 92



Maintenance Kit
Order Ref
WMMK
Page 91



Installation Kit
Order Ref
WMIKU
Page 91



Tanking Kit
Order Ref
WMVS30K
Page 90



WALL MOUNTED UNIDRAIN®

HIGHLINE CASSETTE

THE WALL MOUNTED DRAIN ALLOWS YOU TO HAVE ONE SLOPE, USE LARGE OR SMALL TILES. IDEAL FOR POURED FLOORS SUCH AS POLISHED CONCRETE AND RESIN. YOU NO LONGER HAVE TO STAND ON THE DRAIN IN THE SHOWER.

BENEFITS

- Brushed stainless steel frame and cassette
- 54ltrs of water per minute per outlet.
- Easy to clean by removing cassette and trap.
- Main body pressed from 1.5mm stainless steel.
- Stable and safe with large metal surface flanges for secure waterproofing.
- Internal channel within the drain to prevent stagnant water.
- Approved for wooden and concrete construction.
- No sharp edges.
- BBA approved. 

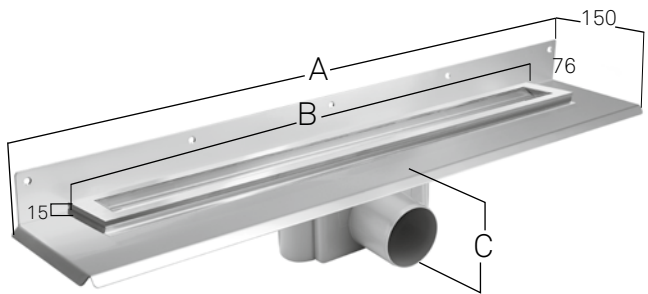
Model No.	A Structural Length	B Visual Length	C Drain Depth	Kit Order Ref	Dimensions
300	432	300	98	1004.0300K4	
600	712	600	102	NA	
700	812	700	103	1004.0700K4	
800	912	800	104	1004.0800K4	
900	1012	900	105	1004.0900K4	
1000	1112	1000	106	1004.1000K4	
1200	1312	1200	108	1004.1200K4	
1400	1509	1400	103	1004.1400K4	
1600	1709	1600	104	1004.1600K4	
1800	1909	1800	105	1004.1800K4	



Linear Drain Strainer
Order Ref
WM1810.0010
Page 92



Hook
Order Ref
WM1840.0000
Page 92



Maintenance Kit
Order Ref
WMMK
Page 91



Installation Kit
Order Ref
WMIKU
Page 91



Tanking Kit
Order Ref
WMVS30K
Page 90



WALL MOUNTED UNIDRAIN®

CORNER DRAIN

THE CORNER DRAIN ALLOWS YOU TO PLACE THE DRAIN AGAINST TWO WALLS IN THE CORNER OF THE SHOWER. IDEAL FOR ANY TILED FLOOR FINISH.

BENEFITS

- Frame and grate brushed stainless steel/tile insert.
- PVD Durable Coating.
- 48ltrs of water per minute.
- Easy to clean by removing grate and trap.
- Main body pressed from 1.5mm stainless steel.
- Stable and safe with large metal surface flanges for secure waterproofing.
- Internal channel within the drain to prevent stagnant water.
- Approved for wooden and concrete construction.
- BBA approved.

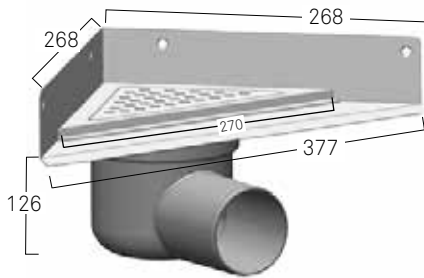

CHOOSE YOUR GRATE STYLE

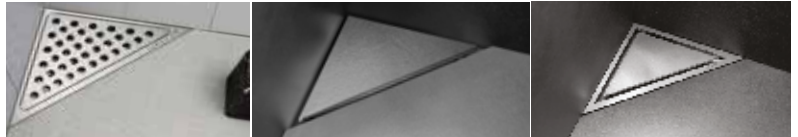

Model No.	A Structural Length	B Visual Length	C Drain Depth	Classic Grate Kit Order Ref	Highline Custom Kit Order Ref	Highline Panel Kit Order Ref
200	268	270	126	2001.0200K1	2001.0200K2	2001.0200K3

OTHER DESIGN OPTIONS AVAILABLE

Price subject to minimum order quantity



Black Brass Copper Polished



Corner Drain Strainer
Order Ref
WM2811.0010
Page 92



Hook
Order Ref
WM1840.0000
Page 92



Maintenance Kit
Order Ref
WMMK
Page 91



Installation Kit
Order Ref
WMIKU
Page 91



Tanking Kit
Order Ref
WMVS30K
Page 90

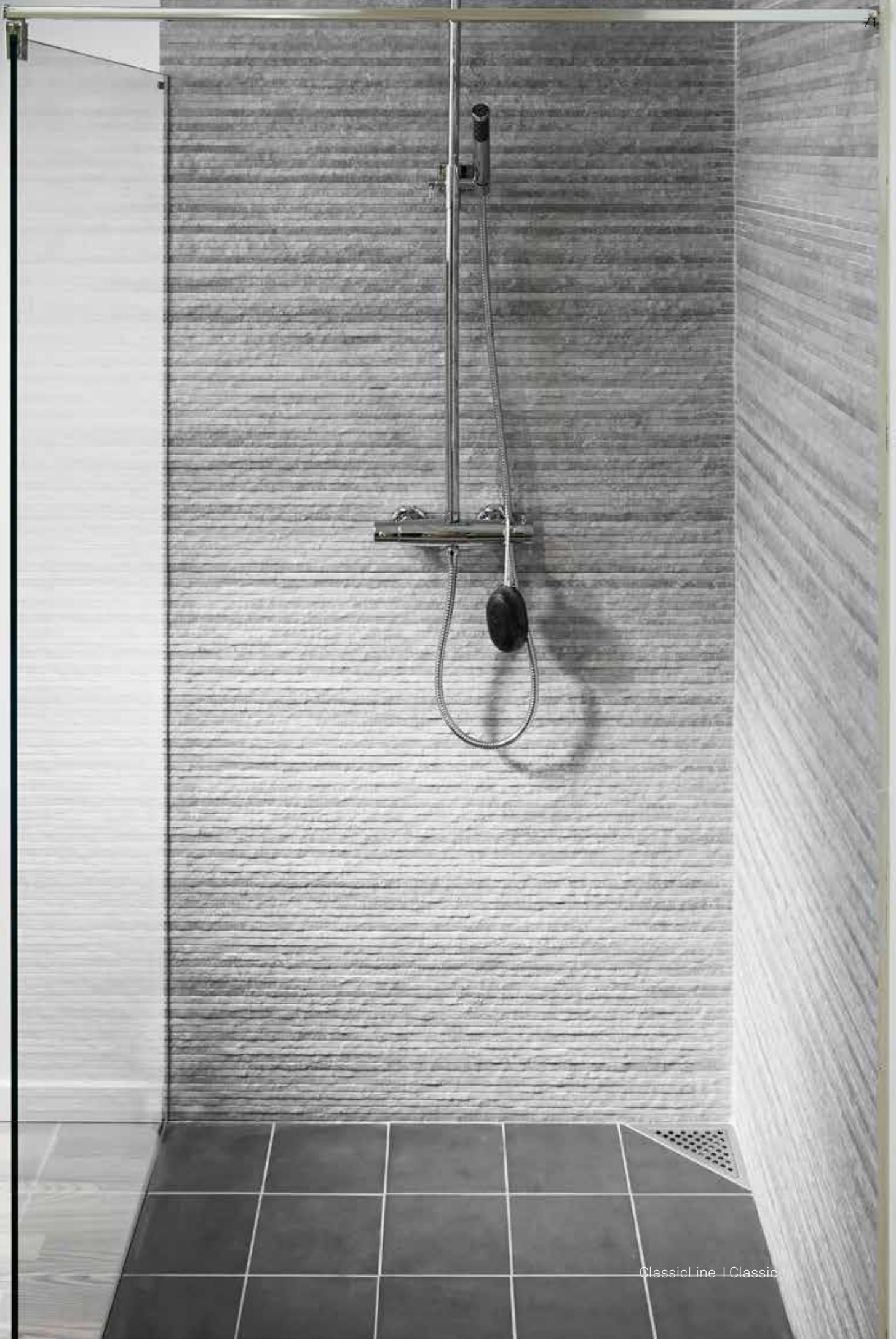

CENTRE FLOOR UNIDRAIN®

CLASSICLINE

THE CENTRE FLOOR DRAIN ALLOWS YOU TO PLACE THE DRAIN AWAY FROM THE WALL. IDEAL FOR ANY TILED FLOOR FINISH.

BENEFITS

- Centre floor classicline frame and grate in a brushed stainless steel finish.
- 54ltrs of water per minute.
- Easy to clean by removing grate and trap.
- Main body pressed from 1.5mm stainless steel.
- Stable and safe with large metal surface flanges for secure waterproofing.
- Internal channel within the drain to prevent stagnant water.
- Approved for wooden and concrete construction.
- No sharp edges.
- BBA approved.



Model No.	A Structural Length	B Visual Length	C Drain Depth	Kit Order Ref
300	432	300	98	3004.0300K1
700	812	700	103	3004.0700K1
800	912	800	104	3004.0800K1
900	1012	900	105	3004.0900K1
1000	1112	1000	106	3004.1000K1
1200	1312	1200	108	3004.1200K1

Dimensions

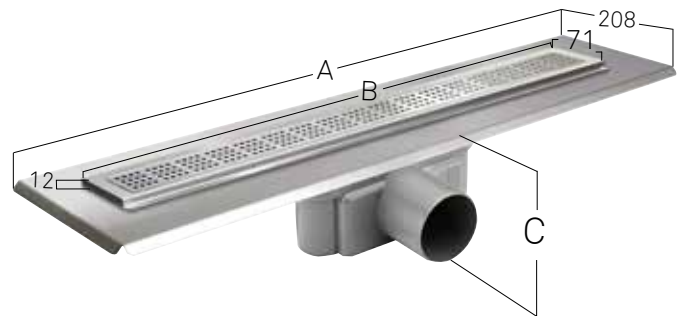

CHOOSE YOUR GRATE STYLE



Classic



Column



Inca



Square



Stripe



Anniversario



Linear Drain Strainer
Order Ref
WM1810.0010
Page 92



Hook
Order Ref
WM1840.0000
Page 92



Maintenance Kit
Order Ref
WMMK
Page 91



Installation Kit
Order Ref
WMIKU
Page 91



Tanking Kit
Order Ref
WMVS30K
Page 90

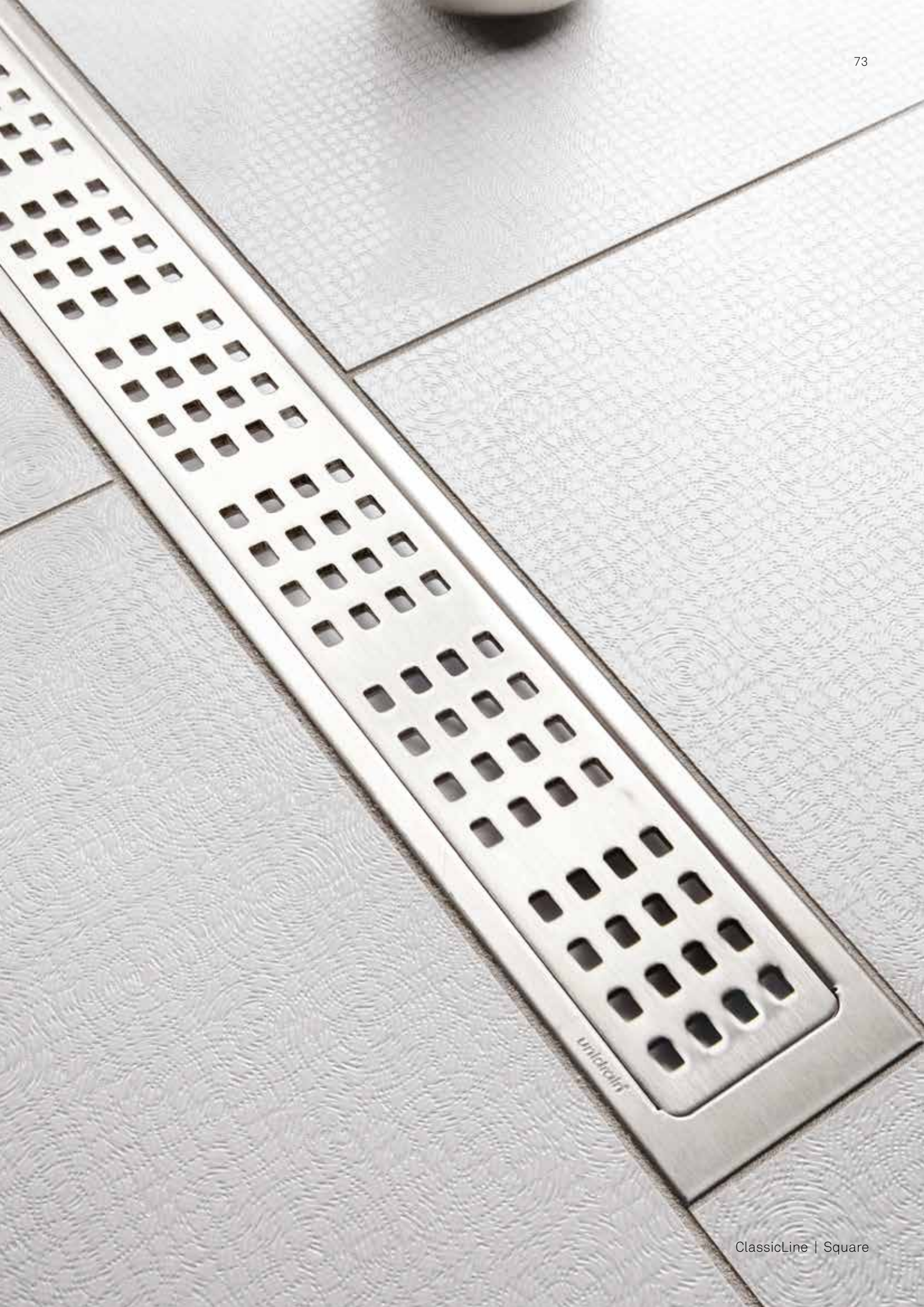

CENTRE FLOOR UNIDRAIN®

HIGHLINE CUSTOM

THE CENTRE FLOOR DRAIN ALLOWS YOU TO PLACE THE DRAIN AWAY FROM THE WALL. IDEAL FOR ANY TILED FLOOR FINISH. THIS RANGE ALLOWS YOU TO TILE INTO YOUR DRAIN AND MAKE THE DRAIN COMPLETELY INVISIBLE.

BENEFITS

- Perfect for stone and porcelain tiles.
- 54ltrs of water per minute.
- Easy to clean by removing custom base and trap.
- Main body pressed from 1.5mm stainless steel.
- Stable and safe with large metal surface flanges for secure waterproofing.
- Internal channel within the drain to prevent stagnant water.
- Approved for wooden and concrete construction.
- No sharp edges.
- BBA approved.



Model No.	A Structural Length	B Visual Length	C Drain Depth	Kit Order Ref	Dimensions
300	432	253	98	3004.0300K2	
700	812	633	103	3004.0700K2	
800	912	733	104	3004.0800K2	
900	1012	833	105	3004.0900K2	
1000	1112	933	106	3004.1000K2	
1200	1312	1133	108	3004.1200K2	



Linear Drain Strainer
Order Ref
WM1810.0010
Page 92



Hook
Order Ref
WM1840.0000
Page 92



Maintenance Kit
Order Ref
WMMK
Page 91



Installation Kit
Order Ref
WMIKU
Page 91



Tanking Kit
Order Ref
WMVS30K
Page 90



CENTRE FLOOR UNIDRAIN®

HIGHLINE PANEL WITHOUT FRAME

THE CENTRE FLOOR DRAIN ALLOWS YOU TO PLACE THE DRAIN AWAY FROM THE WALL. IDEAL FOR ANY TILED FLOOR FINISH.

BENEFITS

- Panel and frame
- PVD Durable Coating.
- Perfect for stone and porcelain tiles.
- 54ltrs of water per minute.
- Easy to clean by removing panel and trap.
- Main drain body pressed from 1.5mm stainless steel.
- Stable and safe with large metal surface flanges for secure waterproofing.
- Internal channel within the drain to prevent stagnant water.
- Approved for wooden and concrete construction.
- BBA approved.

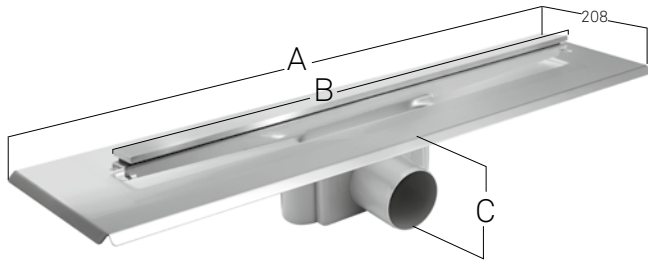

DESIGN OPTION WITHOUT FRAME



Model No.	A Structural Length	B Visual Length	C Drain Depth	HighLine Panel Brushed Stainless Steel Kit Order Ref	HighLine Panel Brass Kit Order Ref	HighLine Panel Copper Kit Order Ref	HighLine Panel Black Kit Order Ref	HighLine Polished Stainless Steel Kit Order Ref
300	432	253	98	3004.0300K3NF	3004.0300K5NF	3004.0300K6NF	3004.0300K7NF	3004.0300K8NF
700	812	633	103	3004.0700K3NF	3004.0700K5NF	3004.0700K6NF	3004.0700K7NF	3004.0700K8NF
800	912	733	104	3004.0800K3NF	3004.0800K5NF	3004.0800K6NF	3004.0800K7NF	3004.0800K8NF
900	1012	933	105	3004.0900K3NF	3004.0900K5NF	3004.0900K6NF	3004.0900K7NF	3004.0900K8NF
1000	1112	1033	106	3004.1000K3NF	3004.1000K5NF	3004.1000K6NF	3004.1000K7NF	3004.1000K8NF
1200	1312	1133	108	3004.1200K3NF	3004.1200K5NF	3004.1200K6NF	3004.1200K7NF	3004.1200K8NF



Linear Drain Strainer
Order Ref
WM1810.0010
Page 92



Hook
Order Ref
WM1840.0000
Page 92



Maintenance Kit
Order Ref
WMMK
Page 91



Installation Kit
Order Ref
WMIKU
Page 91



Tanking Kit
Order Ref
WMVS30K
Page 90



CENTRE FLOOR UNIDRAIN®

HIGHLINE PANEL WITH FRAME

THE CENTRE FLOOR DRAIN ALLOWS YOU TO PLACE THE DRAIN AWAY FROM THE WALL. IDEAL FOR ANY TILED FLOOR FINISH.

BENEFITS

- Panel and frame in a brushed stainless steel finish.
- Perfect for stone, porcelain tiles and polished concrete.
- 54ltrs of water per minute.
- Easy to clean by removing panel and trap.
- Main body pressed from 1.5mm stainless steel.
- Stable and safe with large metal surface flanges for secure waterproofing.
- Internal channel within the drain to prevent stagnant water.
- Approved for wooden and concrete construction.
- No sharp edges.
- BBA approved.



Model No.	A Structural Length	B Visual Length	C Drain Depth	Highline Custom Kit Order Ref	Dimensions
300	432	300	98	3004.0300K3	
700	812	700	103	3004.0700K3	
800	912	800	104	3004.0800K3	
900	1012	900	105	3004.0900K3	
1000	1112	1000	106	3004.1000K3	
1200	1312	1200	108	3004.1200K3	

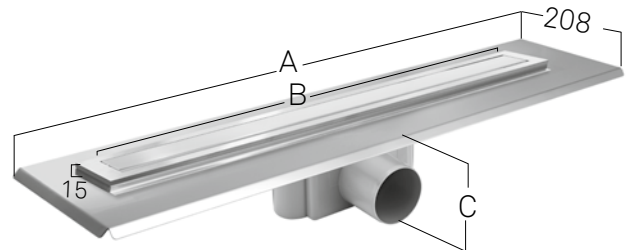

Linear Drain Strainer
Order Ref
WM1810.0010
Page 92



Hook
Order Ref
WM1840.0000
Page 92



Maintenance Kit
Order Ref
WMMK
Page 91



Installation Kit
Order Ref
WMIKU
Page 91



Tanking Kit
Order Ref
WMVS30K
Page 90



CENTRE FLOOR UNIDRAIN®

HIGHLINE CASSETTE

THE CENTRE FLOOR DRAIN ALLOWS YOU TO PLACE THE DRAIN AWAY FROM THE WALL. IDEAL FOR ANY TILED FLOOR FINISH.

BENEFITS

- Frame in a brushed stainless steel finish and cassette.
- 54ltrs of water per minute.
- Easy to clean by removing the cassette and trap.
- Main body pressed from 1.5mm stainless steel.
- Stable and safe with large metal surface flanges for secure waterproofing.
- Internal channel within the drain to prevent stagnant water.
- No sharp edges.
- BBA approved.



Model No.	A Structural Length	B Visual Length	C Drain Depth	Kit Order Ref	Dimensions
300	432	300	98	3004.0300K4	
700	812	700	103	3004.0700K4	
800	912	800	104	3004.0800K4	
900	1012	900	105	3004.0900K4	
1000	1112	1000	106	3004.1000K4	
1200	1312	1200	108	3004.1200K4	

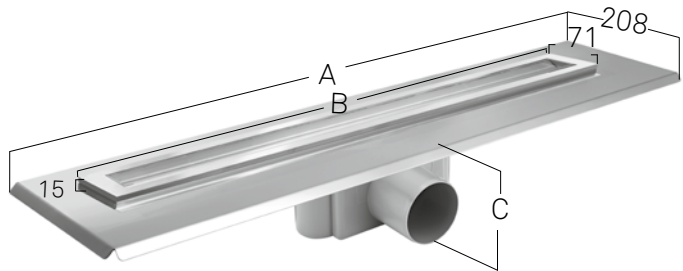

Linear Drain Strainer
Order Ref
WM1810.0010
Page 92



Hook
Order Ref
WM1840.0000
Page 92



Maintenance Kit
Order Ref
WMMK
Page 91



Installation Kit
Order Ref
WMIKU
Page 91



Tanking Kit
Order Ref
WMVS30K
Page 90



UNIDRAIN® SQUARE

THE UNIDRAIN SQUARE FLOOR DRAIN GIVES THE OPPORTUNITY TO HAVE THE SAME STREAMLINED UNIDRAIN LOOK AND FEEL IN ALL ROOMS, WHERE A FLOOR DRAIN IS NEEDED AND WHERE A LINEAR DRAIN IS NOT AN OPTION.

BENEFITS

- Tile insert / frame and grate in a brushed stainless steel finish.
- Customised tile solution possible (100 x 100 mm and 150 x 150 mm).
- 100 x 100 mm and 150 x 150 mm gratings fit the same drain unit.
- 46ltrs - 84ltrs per minute depending on outlet.
- Low installation height (from 107 mm).

DESIGN OPTIONS

Model No.	A Structural Length	B Visual Length	C Drain Depth	Centre Drain Kit Order Ref	Dimensions
WM810	314	100	107	WM82100	
WM815	314	150	107	WM82150	

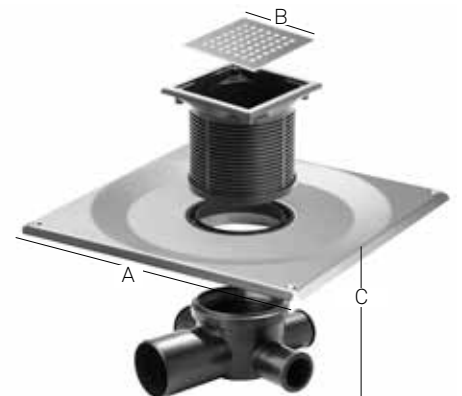

DESIGN OPTIONS

Model No.	A Structural Length	B Visual Length	C Drain Depth	Centre Drain Kit Order Ref	Dimensions
WM810V	314	100	184	WM82100V	
WM815V	314	150	184	WM82150V	

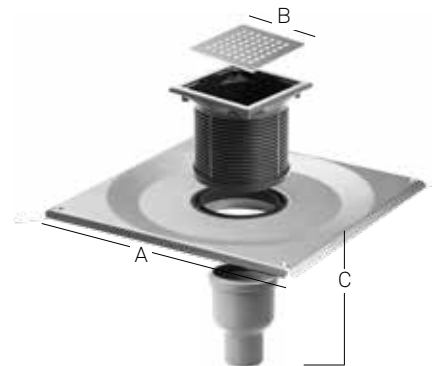

CHOOSE YOUR GRATE STYLE (100MM x 100MM & 150MM x 150MM)



Custom Base

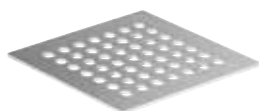

Classic



Column

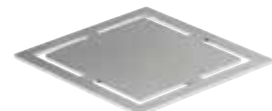

Anniversario



WET ROOM MATERIALS

CENTRE DRAIN

BENEFITS

- Tile insert / frame and grate in a brushed stainless steel/colour finish.
- PVD durable coating.
- 48ltrs of water per minute.
- Easy to clean by removing grate and trap.
- Internal clamping ring for secure waterproofing.
- Mechanical anti-odour trap to prevent foul smells.
- Approved for vinyl, wooden and concrete floors.
- BBA approved.



Vertical option available

WM 59MM CENTRE DRAIN

Model No.	A Structural Length	B Visual Length	C Drain Depth	Centre Drain Kit Order Ref	Dimension
215	200 x 200	59	PM059		

CHOOSE YOUR GRATE STYLE



Art Deco



Classic



Drop

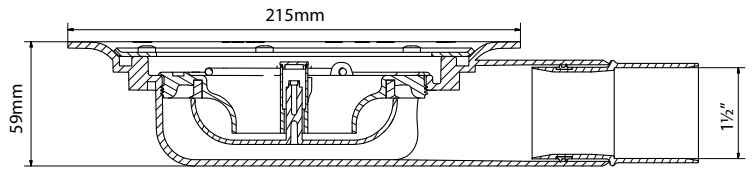

WM 76MM CENTRE DRAIN

Model No.	A Structural Length	B Visual Length	C Drain Depth	Centre Drain Kit Order Ref	Dimension
197	155 x 155	76	PM001	Tile insert 130x130	

CHOOSE YOUR GRATE STYLE



Art Deco



Classic



Drop



Tile Insert

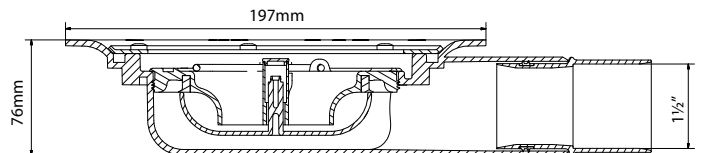

CHOOSE YOUR PVD PANEL STYLE

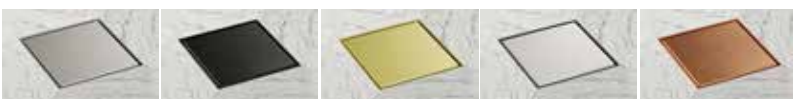

Steel Panel
Kit Order Ref

SDSD.0076SS

Black Panel
Kit Order Ref

SDSD.0076BL

Brass Panel
Kit Order Ref

SDSD.0076BS

Nickel Panel
Kit Order Ref

SDSD.0076NI

Bronze Panel
Kit Order Ref

SDSD.0076BZ



Frame and grate

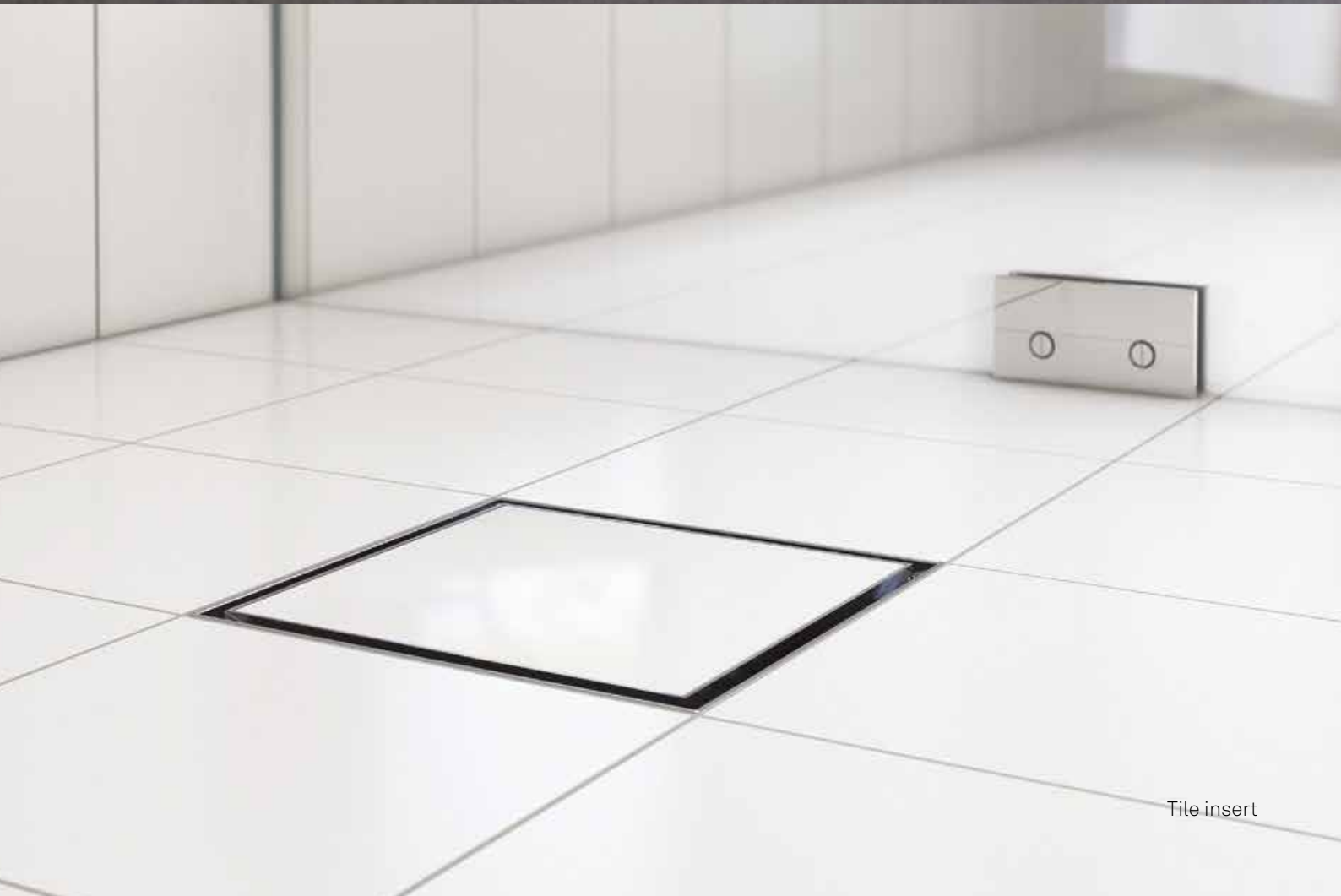

Tile insert

UNIDRAIN®

VINYL FLOOR DRAIN

VINYL FLOOR DRAIN

THE NEW UNIDRAIN VINYL DRAIN BRINGS UNIDRAIN'S FAMOUS SCANDINAVIAN DESIGN INTO BATHROOMS THAT HAVE VINYL FLOORING. THE UNIQUE AND PATENTED DRAIN AND GRATING MAGNETICALLY HOLDS THE GRATE IN PLACE, GIVING IT A STYLISH FINISH AND IS EASY TO REMOVE FOR CLEANING.

BENEFITS

- Easy and quick to install.
- Magnets keep the grating in place without any visible screws and fittings.
- The grate sits flush with the vinyl.
- Easy to clean as the grate is magnetic and can be easily removed.
- Familiar Unidrain components and fitting techniques.

Model No.	A Structural Length	B Visual Length	C Drain Depth	Vinyl Column	Dimensions
700	750	700	110	WM4004.0700	
800	850	800	111	WM4004.0800	
900	950	900	112	WM4004.0900	
1000	1050	1000	113	WM4004.1000	

ADJUSTABLE FEET | Concrete



Length model	Item no.
700-1000 mm	WM4814.0000

MOUNTING SET | Joist floor



Length model	Item no.
700-1000 mm	WM4804.1022



UNIDRAIN® MATLINE



MATLINE IS A FANTASTIC DESIGN FOR THE MODERN HOME. IDEAL FOR AN ACTIVE FAMILY, THE INTELLIGENT MAT SYSTEM IS HIGHLY FUNCTIONAL AND ELEGANT. IT SOLVES THE EVERYDAY PROBLEM OF DIRT IN THE HOME.

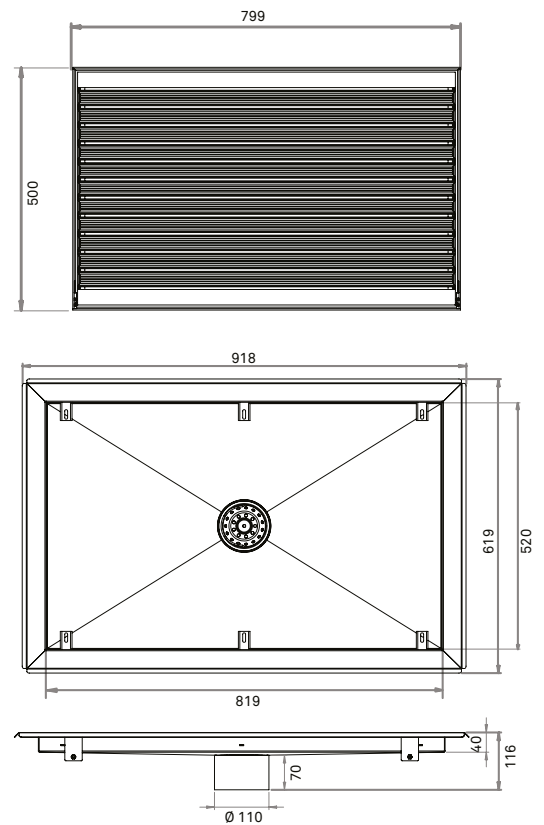
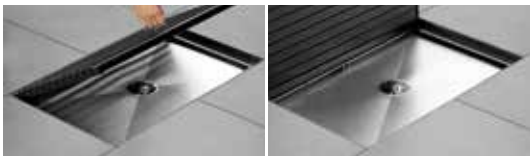

BENEFITS

- Matline combines design and functionality and is a must have for the stylish modern home.
- Consisting of a mat made from long-lasting UV nylon brushes surrounded by a stainless steel frame and floor drain. Matline minimises excess dirt from entering the home.
- Matline can be installed into any floor construction and may be connected to the existing drainage system.
- Matline is ideal for indoor use including utility rooms, kitchens and hallways.
- Matline is easy to clean as the water runs directly into the drain underneath the mat. Dirt falls into the gap between the brush panels.

Model No.	Base width	Base Length	Drain Depth	Kit Order Ref
800	500	800	116	6001.0800

MATLINE ACCESSORIES

Description	Dimension	Order Ref
Nylon brushes - pack of 11	780mm	6001.0801
Steel panel	780mm	6003.0800
Strainer	Ø110mm	6005.0000
Height-adjustable supports set of 4		6006.0000



LIP FOUNDATION MATERIALS

OUR FOUNDATIONS MATERIALS OFFER A RANGE OF PRODUCTS TO COMPLETE YOUR WET ROOM INSTALLATION. DESIGNED TO WORK TOGETHER AND COMPLIMENT THE PROPERTIES OF EACH PRODUCT, THEY HAVE A RANGE OF APPROVALS FROM EC1 PLUS TO ETAG 022 (EUROPEAN TECHNICAL APPROVAL GUIDELINES).

SUGGESTED WATERPROOFING AREA

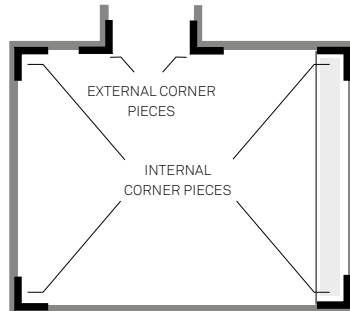
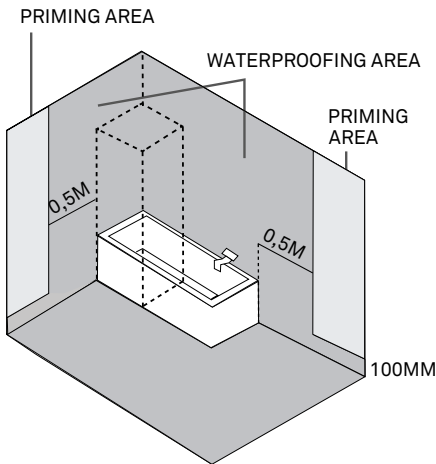

WATERPROOFING MEMBRANE

Easy paint-on application suitable for wood and cement based products. The membrane is designed to move and stretch with your building. Kit consists of Primer, Joint Tape and Liquid Membrane. Coverage: 7-8sqm's with two applications.

Order Ref
WMVS30K



CORNER PIECES

LIP preformed reinforcement tape is used to secure the internal/external corner joints of the wet room. This is used with the LIP VS30.

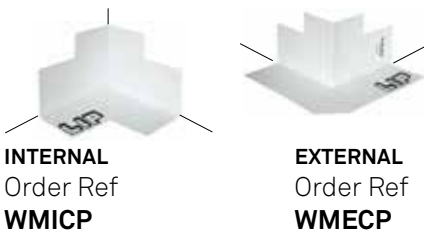

INTERNAL
Order Ref
WMICP

EXTERNAL
Order Ref
WMECP

CONSTRUCTION GLUE

Bond your tiles to the custom rail or a frame to the main drain body. The bond will not disintegrate when in contact with water. Can also be used outside of the shower.

Order Ref
WMCG



TRANSPARENT SILICONE

Provides a flexible waterproof seal for movement joints. The transparent silicone helps protect your bathroom while not impacting its appearance.

Order Ref
WMTS



WET ROOM SCREED

LIP 226 is cement based tension free and fibre reinforced. It retains a slope and goes from 2mm to any thickness in one application.

Coverage: 1.8kg per m² at 1mm thickness.
20kgs Bags

Order Ref
WM226



WET ROOM TILE ADHESIVE

LIP multi tile adhesive (white) is a special, high elasticity, cement-based tile adhesive with great tensile strength. Ideal for wet rooms and showers.

Coverage: 2.5kg per m² at 1mm thickness depending on type of tile.
20kgs Bags

Order Ref
WMSTF25



PURESTEP ACOUSTIC DECOUPLING MAT

Designed to neutralise tension from the subfloor to minimise impact of movement and protect floor tiles. PureStep also provides acoustic reduction properties which reduces sound by up to 70dB.

Order Ref
1m x 5m
WMPS05
1m x 10m
WMPS10
1m x 20m
WMPS20



INSTALLATION / MAINTENANCE KITS

INSTALLATION KIT

The LIP installation kit comes with all the components you need to complete your wetroom installation.

Kit Includes

- 20kg bag of specialist wet room tile adhesive.
- Coverage: 2.5kg per m2 at 1mm thickness depending on tiles.
- Two internal corner pieces to reinforce corner joints.
- WM Bonding glue.
- WM transparent silicone.

Order Ref
WMIKU



MAINTENANCE KIT

We recommend you clean your wetroom drain thoroughly at least every 6-8 weeks to improve longevity. The maintenance kit comes with everything you need to look after your wet room.

Kit includes

- The hook allows you to lift the grate without causing any damage.
- The strainer helps keep the drain clear and is easy to wipe clean.
- WM Cleanser removes lime scale and grease.
- WM Polish treats chrome, stainless steel, tiles and sanitary ware to give a perfect finish.
- WM Grout Sealer should be regularly used to seal grout lines so they cannot absorb water.
- One cloth for cleaning the drain, sanitary ware and tiles.
- One cloth for streak free glass.

Do not use cleaning agents with a high concentration of fluorine, chlorine or hydrogen peroxide.

Order Ref
WMMK



NO HARMFUL CHEMICALS
100% ENVIRONMENTALLY FRIENDLY
BIODEGRADABLE

ACCESSORIES



FOOT REST

Designed to give extra support and comfort while washing and shaving. Available in chrome with stylish etched design prevents your foot from slipping.

86mm x 335mm

Order Ref

WMFR



SOAP SHELF

Brushed stainless steel linear design with an easy to clean removable grate. No screws are required as the shelf is installed between the tiles. Must be placed between two walls.

86mm x 315mm

Order Ref

WM1850.0302



SOAP SHELF

Brushed stainless steel corner design with an easy to clean removable grate. No screws are required as the shelf is installed between the tiles. Must be placed between two walls.

288mm x 204mm

Order Ref

WM2850.0201



LINEAR DRAIN STRAINER

Prevents the drain from becoming clogged and makes it easier to clean as you don't have to remove the trap.

Order Ref

WM1810.0010



CORNER DRAIN STRAINER

Prevents the drain from becoming clogged and makes it easier to clean as you don't have to remove the trap.

Order Ref

WM2811.0010



HOOK

The hook is used to lift the grate out of the frame and the trap from the outlet. Can be used with all models.

Order Ref

WM1840.0000

TECHNICAL INFORMATION

UniSlope® | 1 K

LINEAR DRAIN WALL MOUNTED

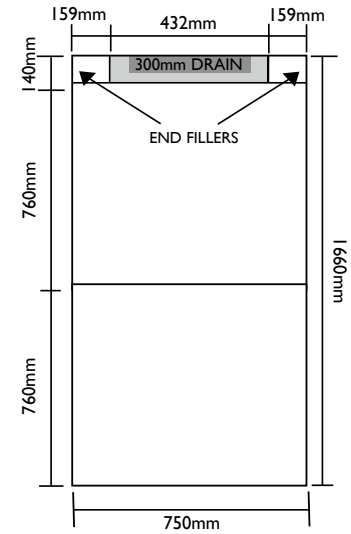
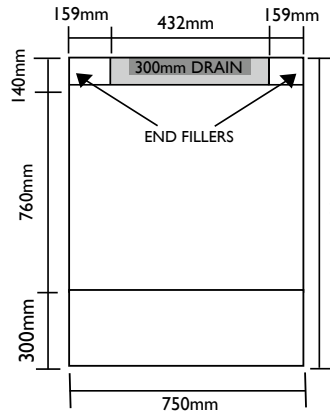
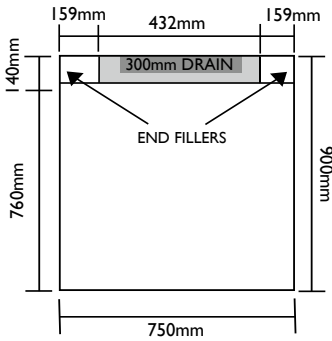
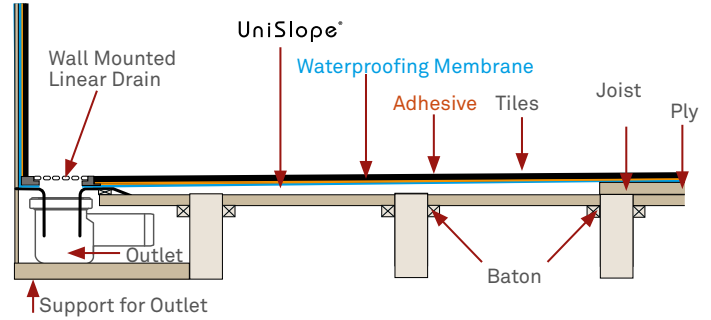

Sizes (in mm)	750 x 900	800 x 900	750 x 1200	800 x 1200	750 x 1660	800 x 1660
Max Dimensions	Max 750 x 900	Max 800 x 900	Max 750 x 1200	Max 800 x 1200	Max 750 x 1660	Max 800 x 1660
Min Dimensions	Min 432 x 500	Min 712 x 500	Min 432 x 900	Min 712 x 900	Min 432 x 1200	Min 712 x 1200
Board Thickness	19mm	19mm	23mm	23mm	30mm	30mm
No. of Boards	1 Board	1 Board	2 Boards	2 Boards	2 Boards	2 Boards
Includes	300mm Drain	600mm Drain	300mm Drain	600mm Drain	300mm Drain	600mm Drain

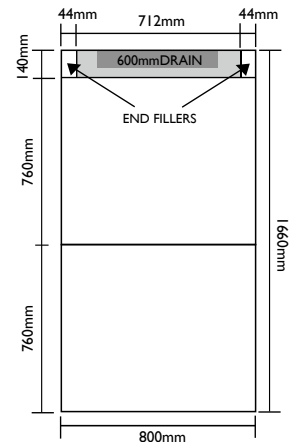
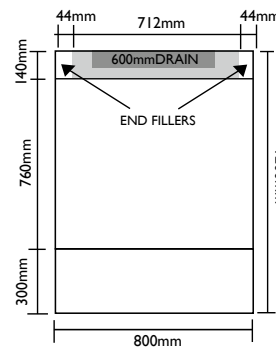
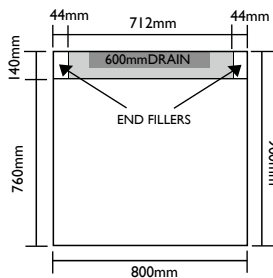

UniSlope® | 1 K

LINEAR DRAIN WALL MOUNTED

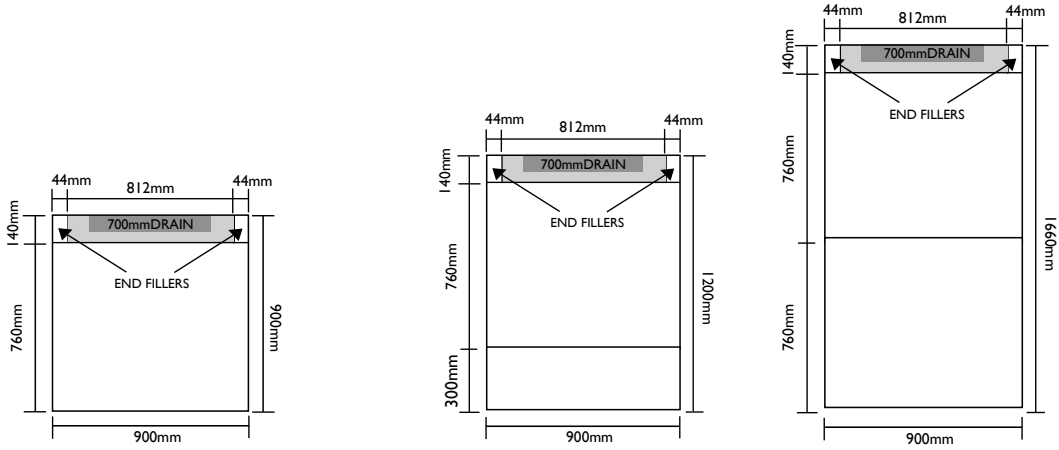

Sizes (in mm)	900 x 900	1200 x 900	900 x 1200	1200 x 1200	900 x 1660	1200 x 1660
Max Dimensions	Max 900 x 900	Max 1200 x 900	Max 900 x 1200	Max 1200 x 1200	Max 900 x 1660	Max 1200 x 1660
Min Dimensions	Min 812 x 500	Min 1012 x 500	Min 812 x 900	Min 1012 x 900	Min 812 x 1200	Min 1012 x 1200
Board Thickness	19mm	19mm	23mm	23mm	30mm	30mm
No. of Boards	1 Board	2 Board	2 Boards	4 Boards	2 Boards	4 Boards
Includes	700mm Drain	900mm Drain	700mm Drain	900mm Drain	700mm Drain	900mm Drain

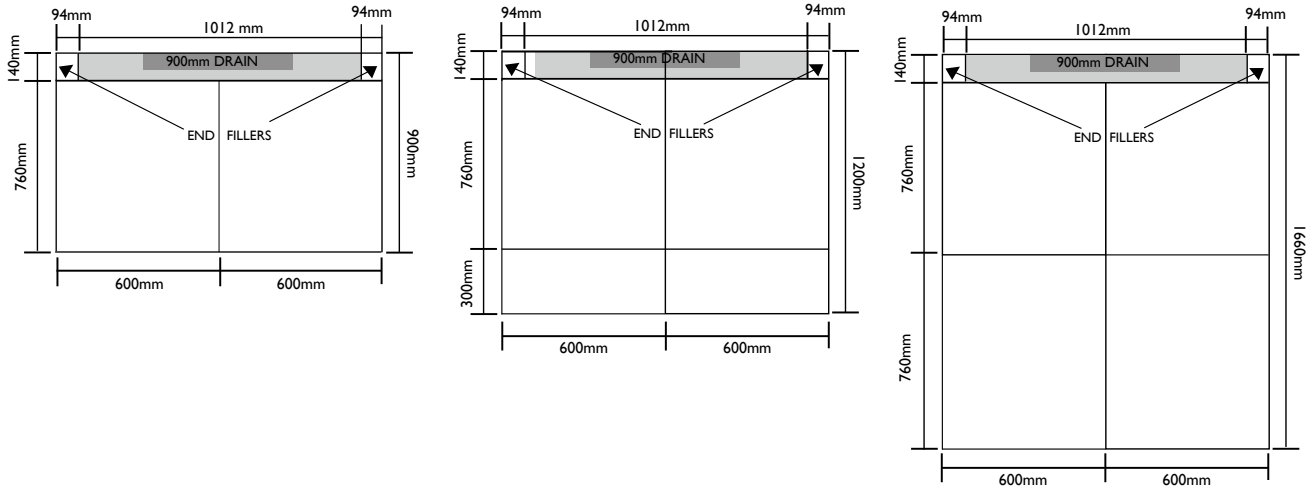

UniSlope® | 1 K

LINEAR DRAIN WALL MOUNTED

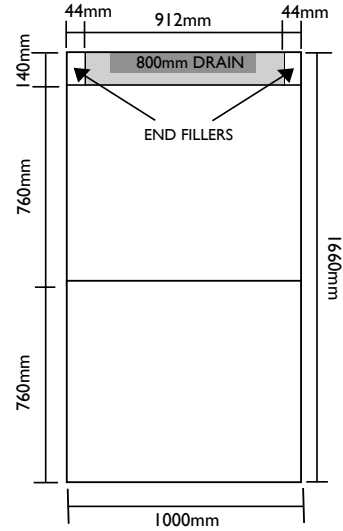
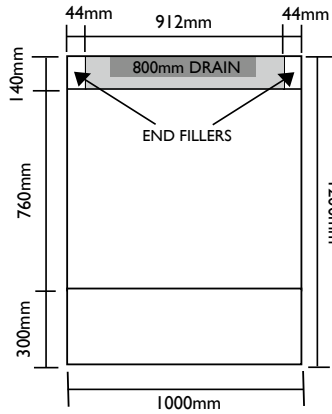
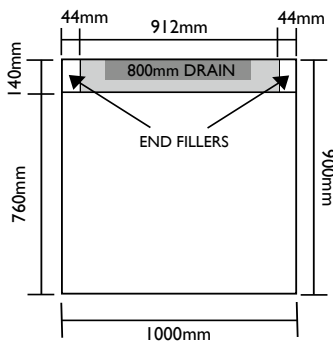

Sizes (in mm)	1000 x 900	1500 x 900	1000 x 1200	1500 x 1200	1000 x 1660	1500 x 1660
Max Dimensions	Max 1000 x 900	Max 1500 x 900	Max 1000 x 1200	Max 1500 x 1200	Max 1000 x 1660	Max 1500 x 1660
Min Dimensions	Min 912 x 500	Min 1112 x 500	Min 912 x 900	Min 1112 x 900	Min 912 x 1200	Min 1112 x 1200
Board Thickness	19mm	19mm	23mm	23mm	30mm	30mm
No. of Boards	1 Board	2 Boards	2 Boards	4 Boards	2 Boards	4 Boards
Includes	800mm Drain	1000mm Drain	800mm Drain	1000mm Drain	800mm Drain	1000mm Drain

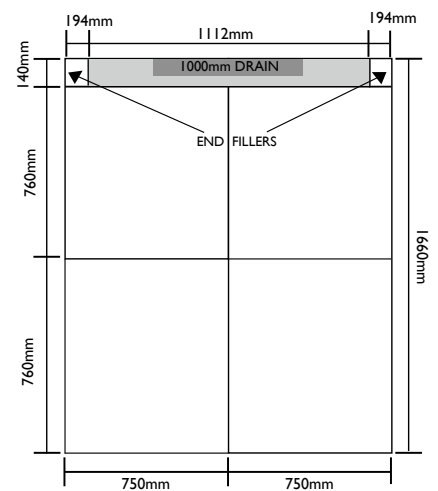
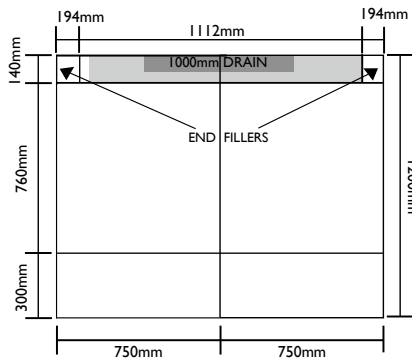
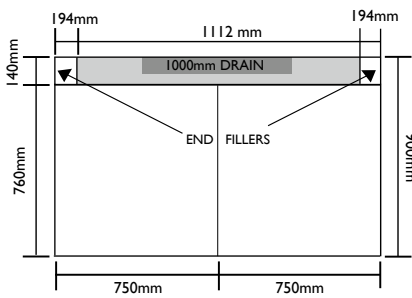

UniSlope® | 1 K

LINEAR DRAIN WALL MOUNTED

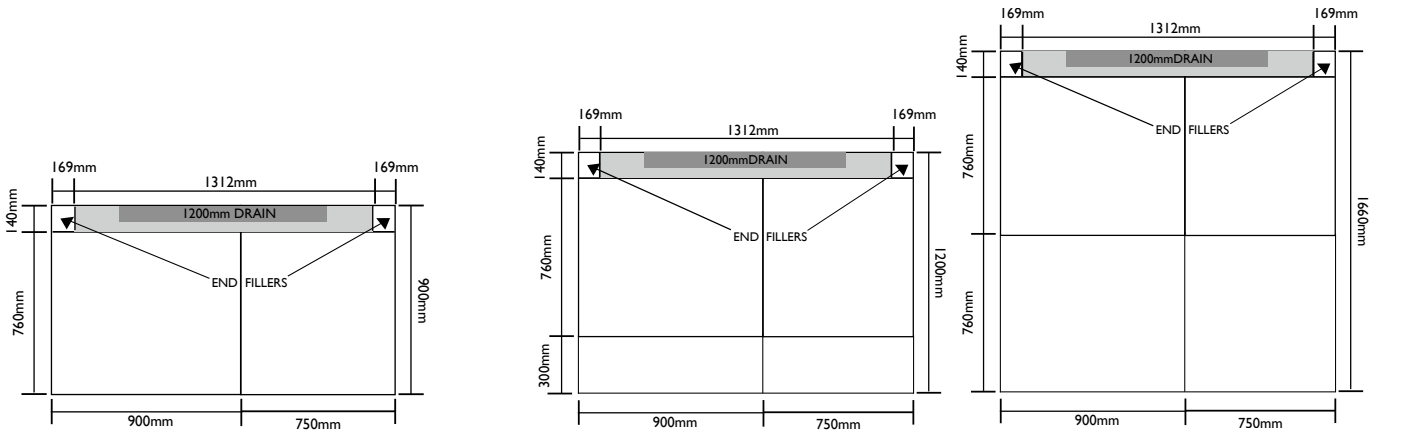

Sizes (in mm)	1650 x 900	1800 x 900	1650 x 1200	1800 x 1200	1650 x 1660	1800 x 1660
Max Dimensions	Max 1650 x 900	Max 1800 x 900	Max 1650 x 1200	Max 1800 x 1200	Max 1650 x 1660	Max 1800 x 1660
Min Dimensions	Min 1312 x 500	Min 1509 x 500	Min 1312 x 900	Min 1509 x 900	Min 1312 x 900	Min 1509 x 900
Board Thickness	19mm	19mm	23mm	23mm	30mm	30mm
No. of Boards	2 Boards	2 Boards	4 Boards	4 Boards	4 Boards	4 Boards
Includes	1200mm Drain	1400mm Drain	1200mm Drain	1400mm Drain	1200mm Drain	1400mm Drain

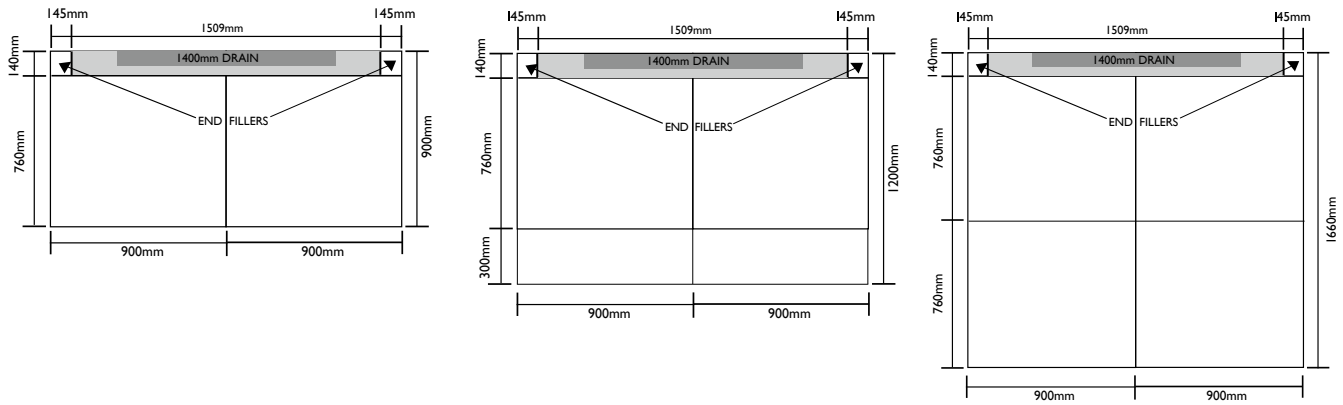

UniSlope® | 1 K

LINEAR DRAIN WALL MOUNTED

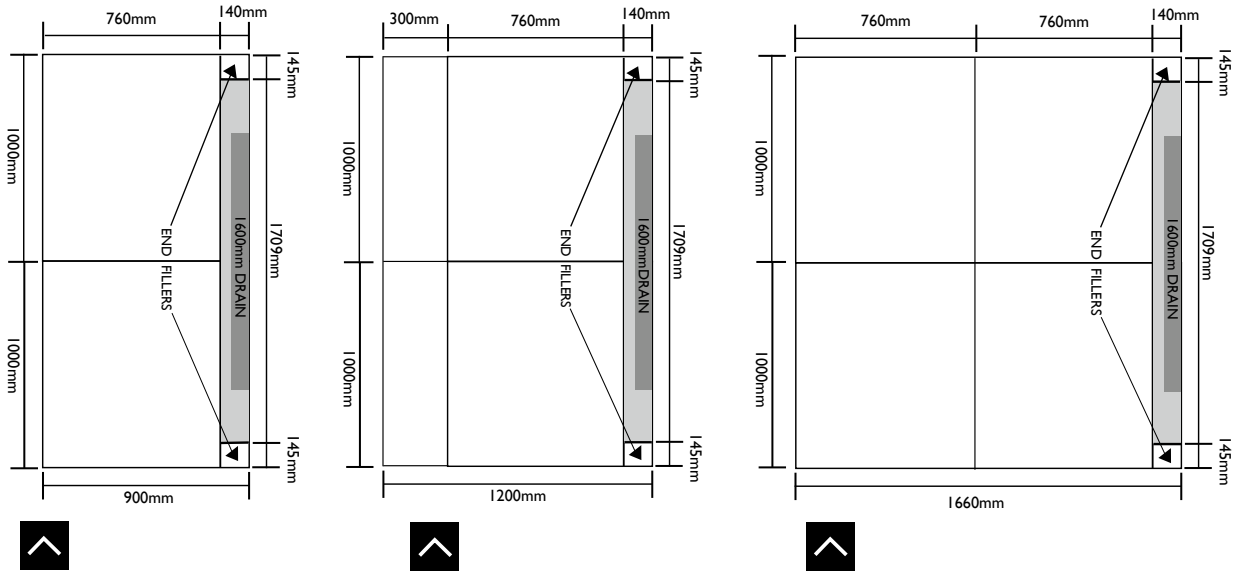

Sizes (in mm)	2000 x 900	2250 x 900	2000 x 1200	2250 x 1200	2000 x 1660	2250 x 1660
Max Dimensions	Max 2000 x 900	Max 2250 x 900	Max 2000 x 1200	Max 2250 x 1200	Max 2000 x 1660	Max 2250 x 1660
Min Dimensions	Min 1709 x 500	Min 1909 x 500	Min 1709 x 900	Min 1909 x 900	Min 1709 x 1200	Min 1909 x 1200
Board Thickness	19mm	19mm	23mm	23mm	30mm	30mm
No. of Boards	2 Boards	3 Boards	4 Boards	6 Boards	4 Boards	6 Boards
Includes	1600mm Drain	1800mm Drain	1600mm Drain	1800mm Drain	1600mm Drain	1800mm Drain

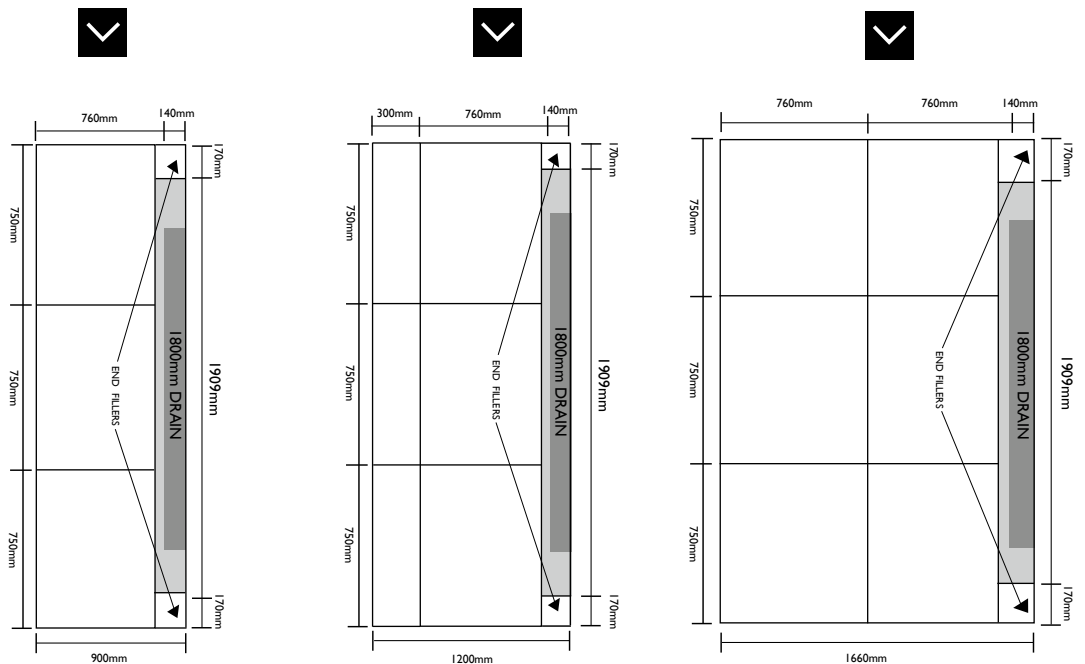

UniSlope® | 1 K

LINEAR DRAIN WALL MOUNTED

BENEFITS

- Award winning drain.
- Standard frame height 12mm Classicline 15mm Highline.
- Made from pressed stainless steel (grade AISI304).
- Large metal flanges for a secure installation.
- High capacity: (54ltrs per min per outlet).
- Easy to clean.
- BBA approved.

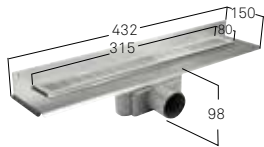

300 mm

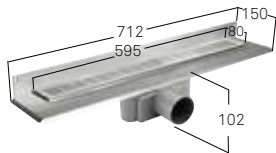

600 mm

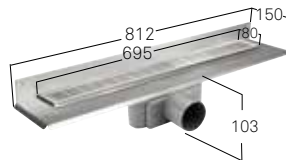

700 mm



800 mm



900 mm



1000 mm



1200 mm

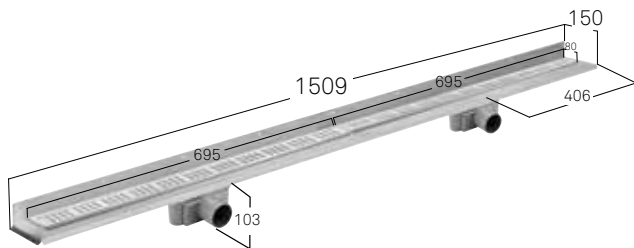

1400 mm

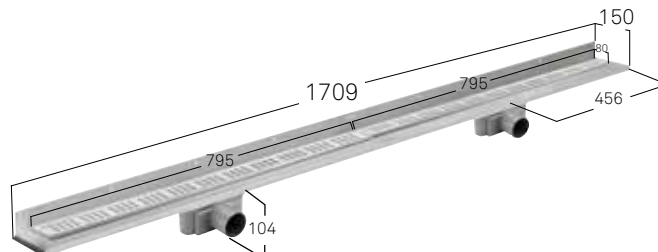

1600 mm

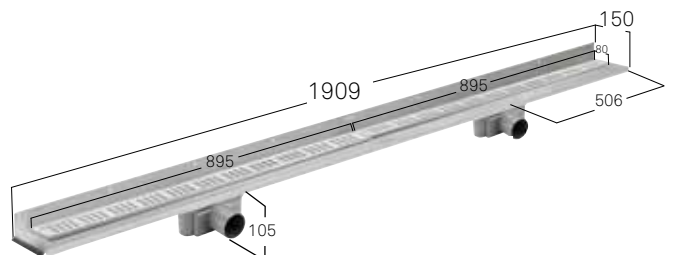

1800 mm

UniSlope® | 2K

LINEAR DRAIN WALL MOUNTED

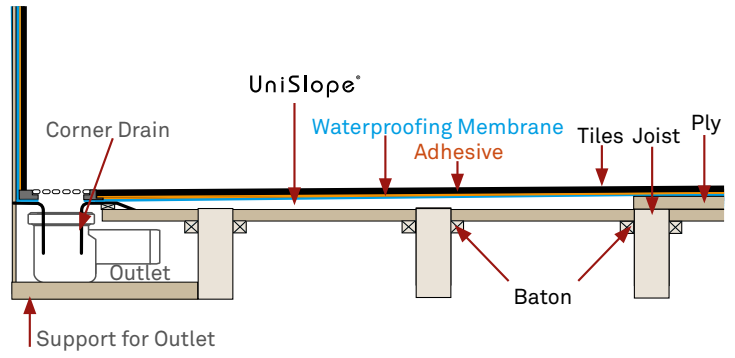

BENEFITS

- Award winning drain.
- Standard frame height 12mm Classicline 15mm Highline.
- Made from pressed stainless steel (grade AISI304).
- Large metal flanges for a secure installation.
- High Capacity: (54ltrs per min per outlet).
- Easy to Clean.
- BBA approved.



Sizes (in mm)	900 x 900
Max Dimensions	Max 900 x 900
Min Dimensions	Min 500 x 500
Board Thickness	19mm
No. of Boards	1 Board
Includes	Corner Drain

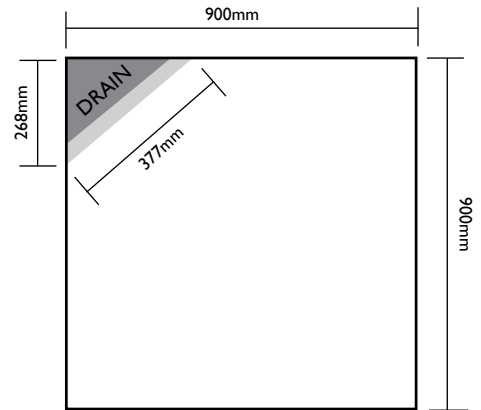
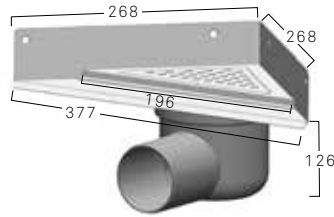

UniSlope® | 3K

FREE PLACEMENT LINEAR DRAIN

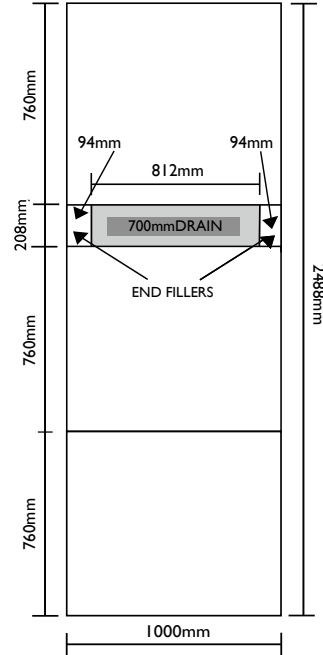
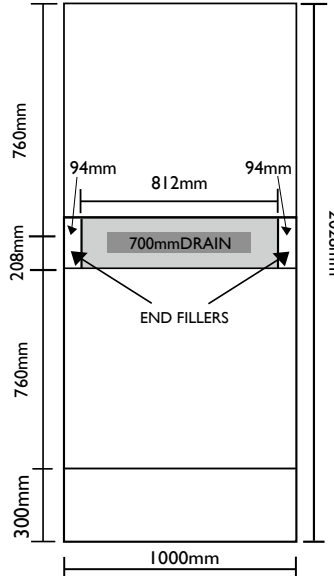
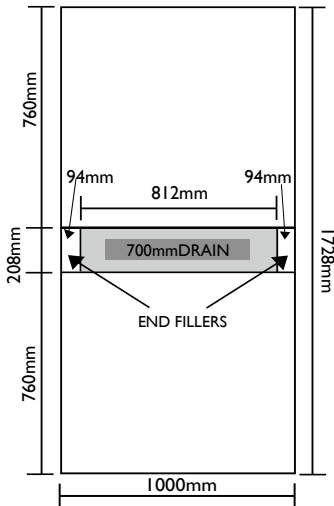
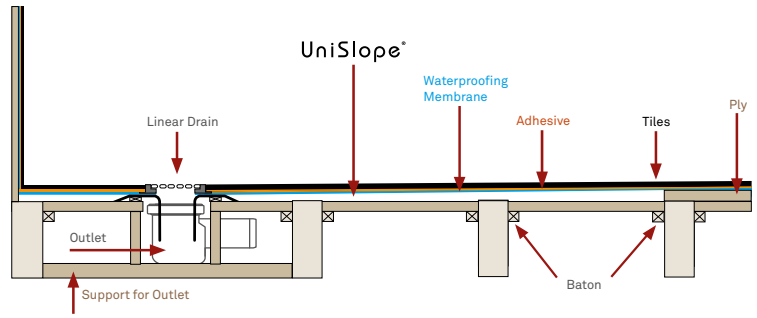

1000 x 1728

Max 1000 x 1728
Min 812 x 500
19mm
2 Boards
700mm Drain

1500 x 1728

Max 1500 x 1728
Min 1312 x 500
19mm
4 Boards
1200mm Drain

1000 x 2028

Max 1000 x 2028
Min 812 x 1728
23mm
3 Boards
700mm Drain

1500 x 2028

Max 1500 x 2028
Min 1312 x 1728
23mm
6 Boards
1200mm Drain

1000 x 2488

Max 1000 x 2488
Min 812 x 2028
30mm
3 Boards
700mm Drain

1500 x 2488

Max 1500 x 2488
Min 1312 x 2028
30mm
6 Boards
1200mm Drain

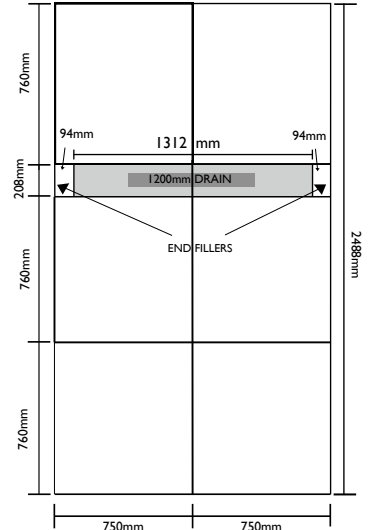
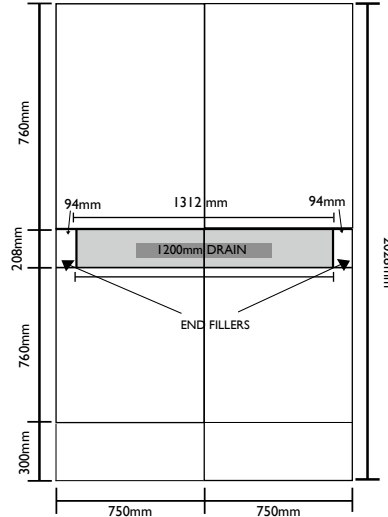
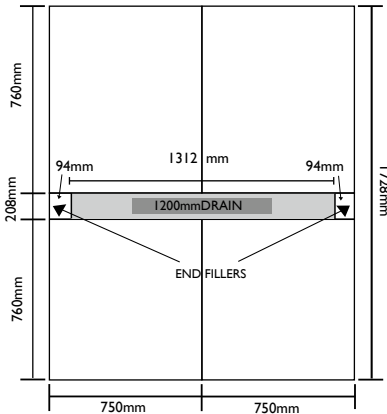

UniSlope® | 3K & 4K

CENTRE FLOOR UNIDRAIN

BENEFITS

- Award winning drain.
- Standard frame height 12mm Classicline 15mm Highline.
- Made from pressed stainless steel (grade AISI304).
- Large metal flanges for a secure installation.
- High capacity: (54ltrs per min per outlet).
- Easy to clean.
- BBA approved. 

CENTRE DRAINS

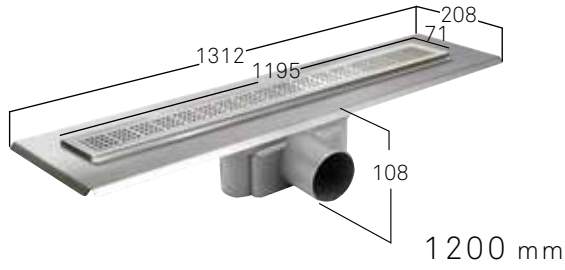
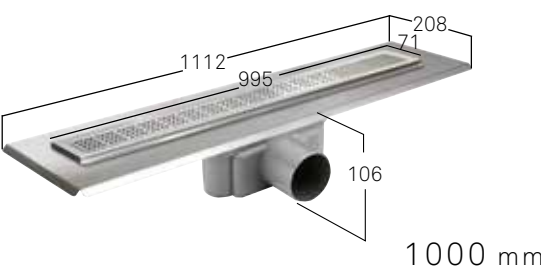
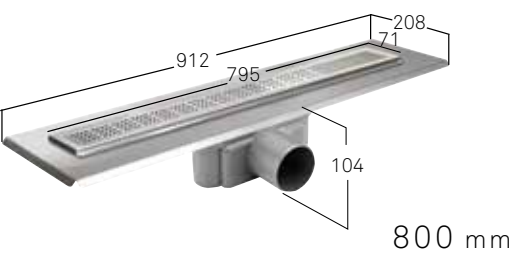
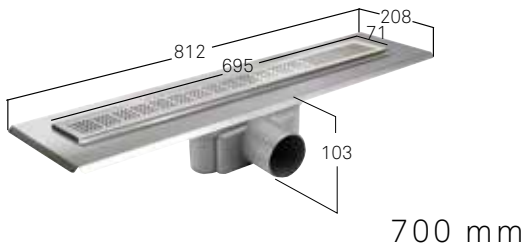
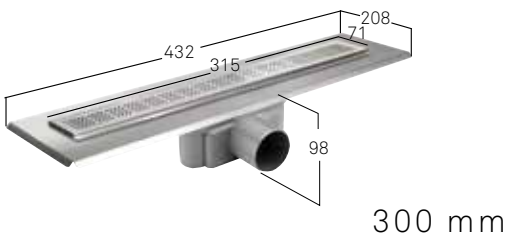

UniSlope® | 4K

LINEAR CENTRE FLOOR DRAIN

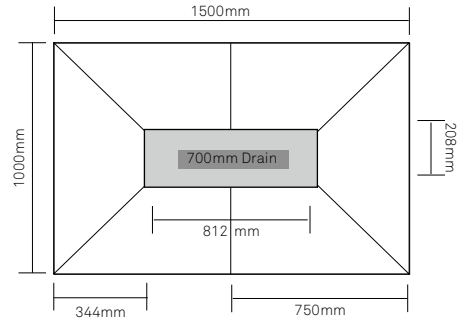
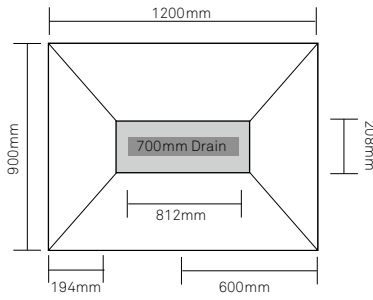
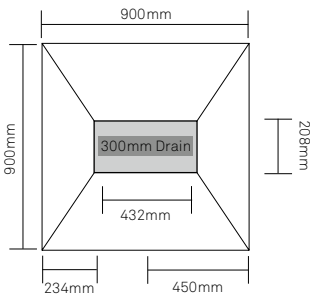
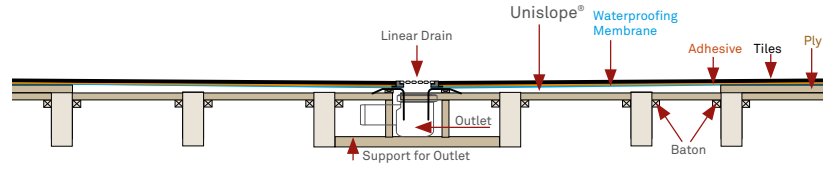

Sizes (in mm)	900 x 900
Max Dimensions	Max 900 x 900
Min Dimensions	Min 600 x 600
Board Thickness	19mm
No. of Boards	1 Board
Includes	300mm Drain



Sizes (in mm)	1200 x 900
Max Dimensions	Max 1200 x 900
Min Dimensions	Min 900 x 600
Board Thickness	19mm
No. of Boards	1 Board
Includes	700mm Drain



Sizes (in mm)	1500 x 1000
Max Dimensions	Max 1500 x 1000
Min Dimensions	Min 1200 x 600
Board Thickness	19mm
No. of Boards	2 Boards
Includes	700mm Drain

TILING HIGHLINE CUSTOM

EXAMPLE WITH 10mm/20mm TILE

The custom solution consists of a rail and a stainless steel base. The shape of the rail ensures accurate fitting inside the unit. The rail and the base are screwed together after which your choice of tile can then be laid.

A HEIGHTENER SET IS INCLUDED FOR HEIGHT ADJUSTMENT OF THE BASE.

FLOOR TILE IS CUT TO ACHIEVE A GAP BETWEEN THE TILE ON THE BASE AND THE OTHER TILES OF AT LEAST 6mm.

CUSTOM RAIL AND BASE SEEN BELOW.

SHORT SIDES

LAY OWN TILES ON BASE WITH OVERHANG OF MAX. 20mm

(DEPENDING ON TILE THICKNESS AND TYPE OF TILE.

IN THIS EXAMPLE THE OVERHANG IS 14mm).

LONG SIDES

LAY OWN TILES ON BASE WITH OVERHANG IS 14mm

(DEPENDING ON TILE THICKNESS AND TYPE OF TILE.)

IN THIS EXAMPLE THE OVERHANG IS 6mm and 14mm.

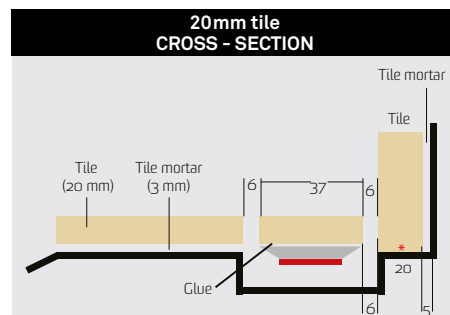
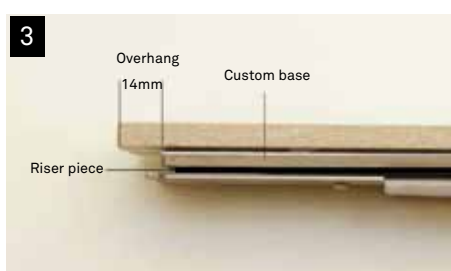
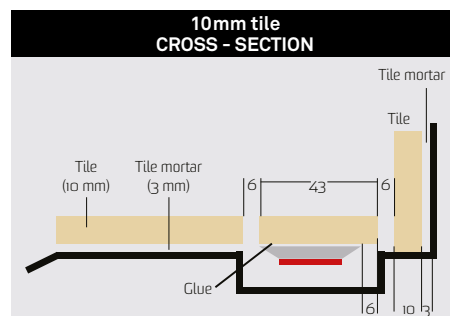
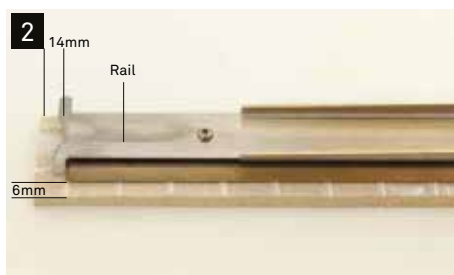
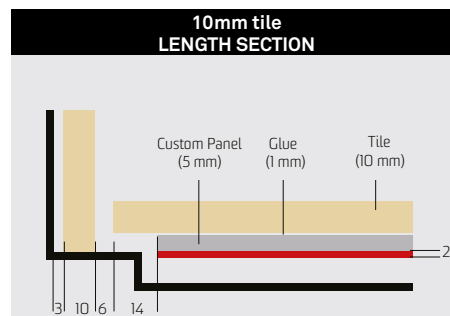
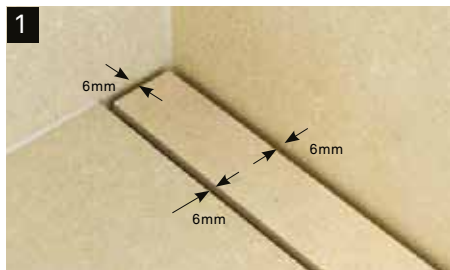

*Extended horizontal flange required for a 20mm tile

UNIDRAIN CLASSICLINE

IDEAL FOR ANY TILED FLOOR FINISH. STANDARD FRAME HEIGHT 12mm.



Drain kit

WALL MOUNTED



Drain kit

CENTRE

UNIDRAIN HIGHLINE CUSTOM

THIS RANGE ALLOWS YOU TO TILE INTO YOUR DRAIN AND MAKE THE DRAIN COMPLETELY INVISIBLE.

IDEAL FOR STONE OR PORCELAIN TILES.



Drain kit

WALL MOUNTED



Drain kit

CENTRE

UNIDRAIN HIGHLINE PANEL

IDEAL FOR Poured FLOORS, TILE OR STONE. AVAILABLE IN A RANGE OF FINISHES. STANDARD FRAME HEIGHT 12mm.



Drain kit

WALL MOUNTED



Drain kit

CENTRE

UNIDRAIN HIGHLINE CASSETTE

IDEAL FOR Poured FLOORS, TILE OR STONE. INFILL THE CASSETTE WITH YOUR CHOSEN FINISH. STANDARD FRAME HEIGHT 12mm.



Drain kit

WALL MOUNTED



Drain kit

CENTRE

MAINBODY OPTIONS FOR UNIDRAIN®

LINEAR DRAIN WALL MOUNTED

REAR WALL FLANGE / CENTRE OUTLET



Product Ref

1004.0000

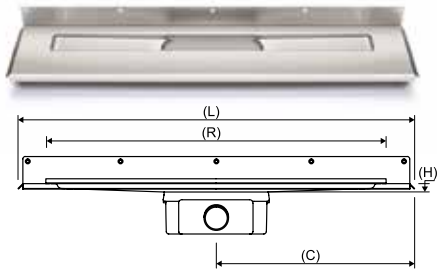

3 WALL FLANGES / CENTRE OUTLET



Product Ref

1001.0000

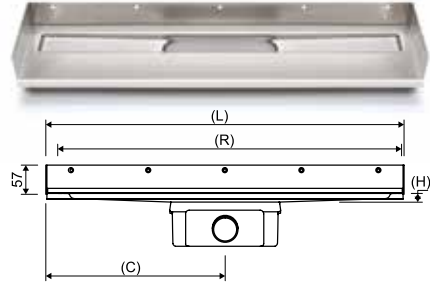

LEFT & REAR WALL FLANGES / CENTRE OUTLET



Product Ref

1002.0000

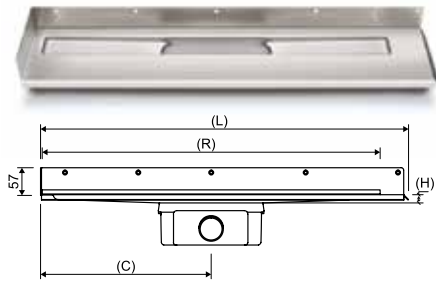

RIGHT & REAR WALL FLANGES / CENTRE OUTLET



Product Ref

1003.0000

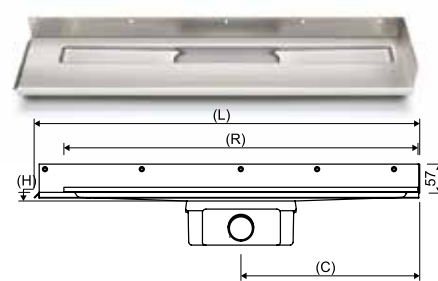

CLASSICLINE FRAME AND GRATE ONLY FOR THE MAIN BODIES BELOW

REAR WALL FLANGE / LEFT OUTLET



Product Ref

1004.0006

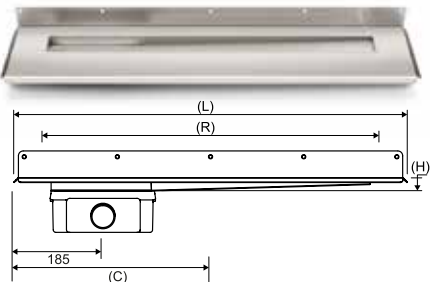

REAR WALL FLANGE / RIGHT OUTLET



Product Ref

1004.0005

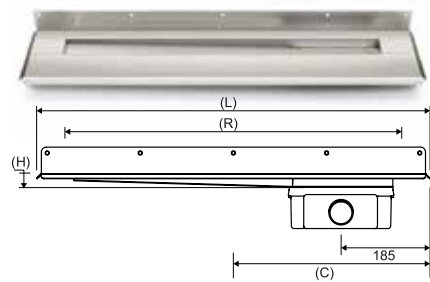

OUTLETS

WE STOCK A WIDE RANGE OF OUTLETS FROM LOW PROFILE TO HIGH CAPACITY. OUR LOW PROFILE OUTLET (1417.0050) ONLY REQUIRES FLOOR DEPTH OF 64MM. OUR MOST POPULAR ARE DETAILED BELOW.

LOW PROFILE ANTI ODOUR



Order Ref
1417.0050

BENEFITS

- Capacity 36ltrs of water per minute
- Horizontal outlet
- 50mm pipe work
- Built-in odour barrier
- Mechanical trap can be removed, separated and cleaned
- Can be turned 180° if a backward facing outlet is required

STANDARD



Order Ref
1411.0050

BENEFITS

- Capacity 54ltrs of water per minute
- Horizontal outlet
- 50mm pipe work
- Built-in water trap
- Water trap can be removed, separated and cleaned
- Can be turned 180° if a backward facing outlet is required

HIGH CAPACITY

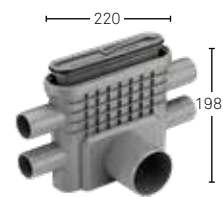

Order Ref
1413.0075

BENEFITS

- Capacity 84ltrs of water per minute
- Horizontal outlet
- 75mm pipe work
- Built-in water trap
- Water trap can be removed, separated and cleaned
- Can be turned 180° if a backward facing outlet is required



Order Ref
1415.0050

BENEFITS

- Capacity 48ltrs of water per minute
- Horizontal outlet
- 50mm pipe work
- Built-in water trap
- Water trap can be removed, separated and cleaned



Order Ref
1412.0075

BENEFITS

- Capacity 90ltrs of water per minute
- Vertical outlet
- 75mm pipe work
- Built-in water trap
- Water trap can be removed, separated and cleaned



Order Ref
1312.0050

BENEFITS

- Capacity 102 ltrs of water per minute (no water trap)
- Vertical outlet
- 50mm pipe work
- Water trap is optional
- Water trap can be removed, separated and cleaned

OTHER OUTLETS AVAILABLE IF REQUIRED

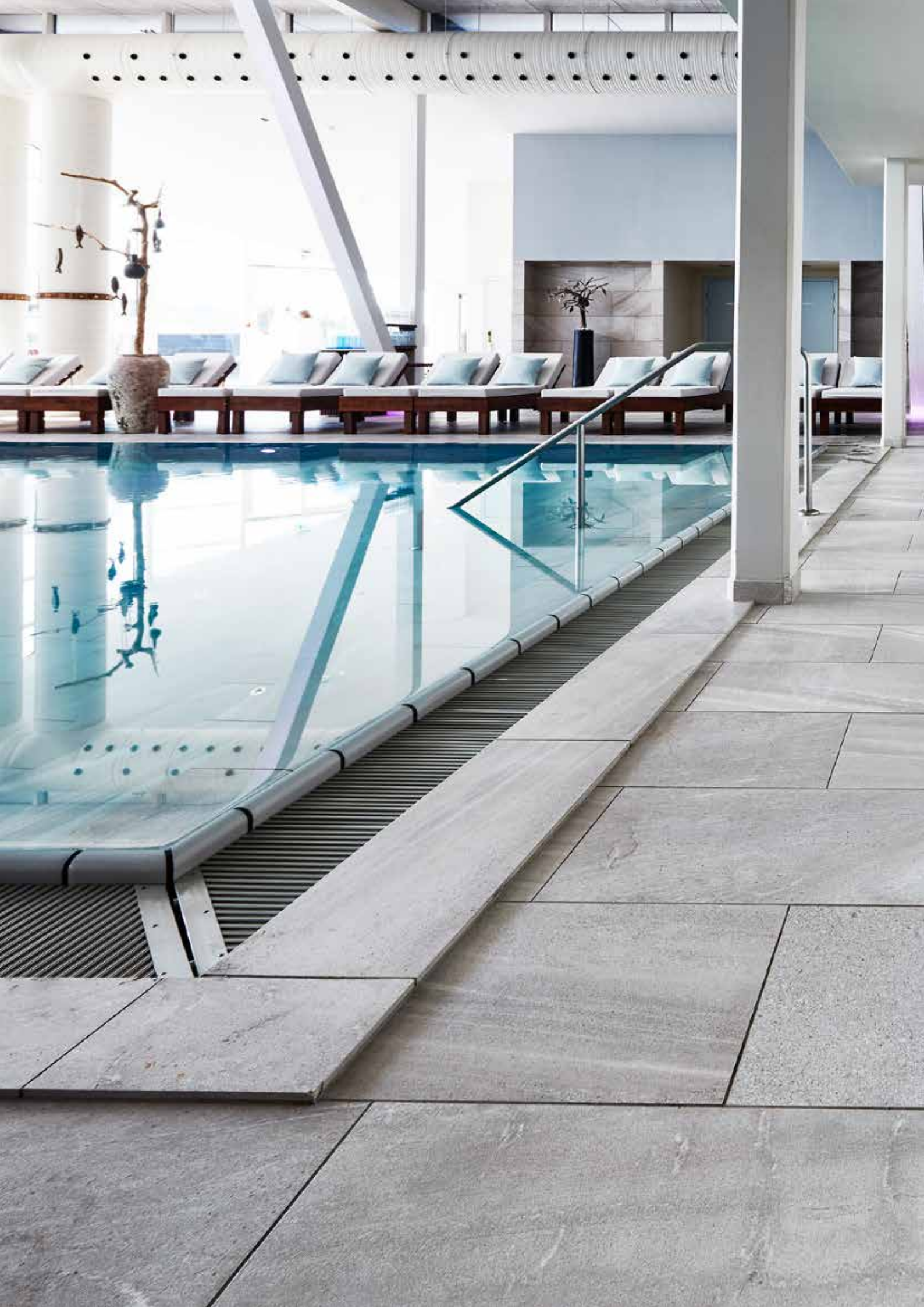

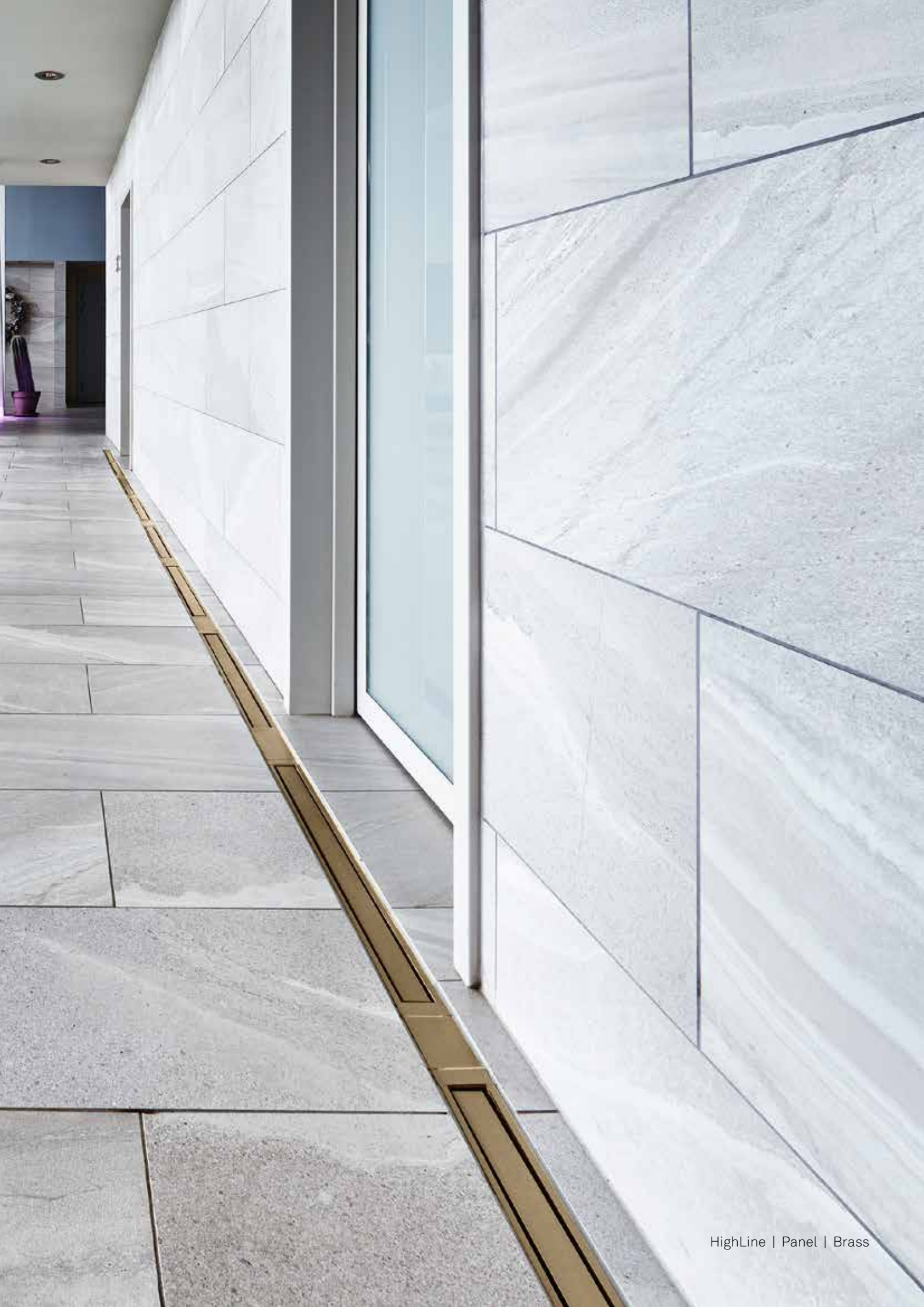

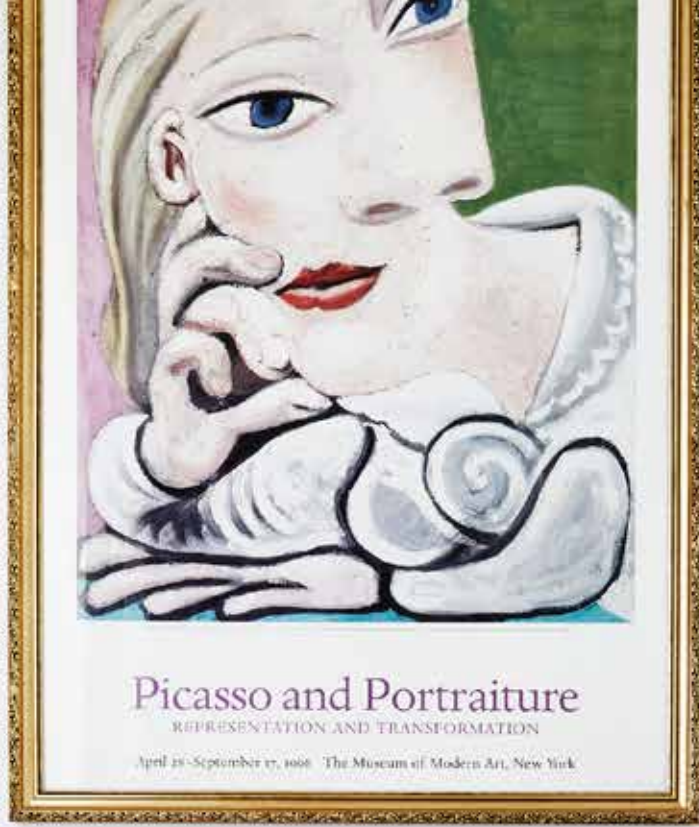





wm
wetroom materials

Wetroom Materials UK
Derwentside
25 Town Street
Duffield
Belper
Derbyshire
DE56 4EH
England
+ 44 (0) 1332 840 820

Wetroom Materials Ireland
Unit E1
Ballymount Ind Est
Walkinstown
Dublin
Co. Dublin
D12 WR60
Ireland
+353 (0)1 2973488

sales@wetroommaterials.com
www.wetroommaterials.com

HighLine | Panel | Black and ReFrame