

# THE PLATINUM COLLECTION

SCANDINAVIAN WETROOM SOLUTIONS

## STERLING PRICE LIST

# UniSlope® | 1 K

## ALL KITS INCLUDE

A DRAIN – 48LTR / MIN  
 PREFORMED SLOPE BOARD  
 8m<sup>2</sup> WATERPROOFING SYSTEM



Wall Mounted Drain



Preformed Slope



Waterproofing kit

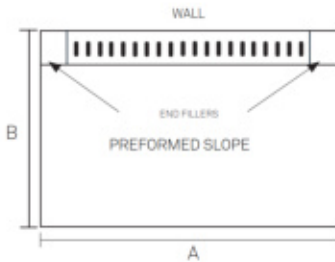

Size		Minimum		Board	Drain	Anniversario Grate	RRP Ex VAT	Highline Custom	RRP Ex VAT	Highline Panel	RRP Ex VAT	Highline Cassette	RRP Ex VAT
A	B	Size	Height										
750	x	900	432 x 500	19	300	1K0750.09001	£1,025.00	1K0750.09002	£1,034.00	1K0750.09003	£1,265.00	1K0750.09004	£1,212.00
750	x	1200	432 x 900	23	300	1K0750.12001	£1,142.00	1K0750.12002	£1,151.00	1K0750.12003	£1,382.00	1K0750.12004	£1,330.00
750	x	1660	432 x 1200	30	300	1K0750.16601	£1,222.00	1K0750.16602	£1,230.00	1K0750.16603	£1,462.00	1K0750.16604	£1,408.00
800	x	900	712 x 500	19	600	1K0800.09001	£1,174.00	1K0800.09002	£1,216.00	N/A		N/A	
800	x	1200	712 x 900	23	600	1K0800.12001	£1,333.00	1K0800.12002	£1,374.00	N/A		N/A	
800	x	1660	712 x 1200	30	600	1K0800.16601	£1,427.00	1K0800.16602	£1,467.00	N/A		N/A	
900	x	900	812 x 500	19	700	1K0900.09001	£1,174.00	1K0900.09002	£1,216.00	1K0900.09003	£1,494.00	1K0900.09004	£1,433.00
900	x	1200	812 x 900	23	700	1K0900.12001	£1,333.00	1K0900.12002	£1,374.00	1K0900.12003	£1,652.00	1K0900.12004	£1,590.00
900	x	1660	812 x 1200	30	700	1K0900.16601	£1,427.00	1K0900.16602	£1,467.00	1K0900.16603	£1,746.00	1K0900.16604	£1,684.00
1000	x	900	912 x 500	19	800	1K1000.09001	£1,203.00	1K1000.09002	£1,254.00	1K1000.09003	£1,527.00	1K1000.09004	£1,479.00
1000	x	1200	912 x 900	23	800	1K1000.12001	£1,216.00	1K1000.12002	£1,411.00	1K1000.12003	£1,684.00	1K1000.12004	£1,638.00
1000	x	1660	912 x 1200	30	800	1K1000.16601	£1,456.00	1K1000.16602	£1,505.00	1K1000.16603	£1,778.00	1K1000.16604	£1,732.00
1200	x	900	1012 x 500	19	900	1K1200.09001	£1,321.00	1K1200.09002	£1,376.00	1K1200.09003	£1,670.00	1K1200.09004	£1,621.00
1200	x	1200	1012 x 900	23	900	1K1200.12001	£1,556.00	1K1200.12002	£1,611.00	1K1200.12003	£1,904.00	1K1200.12004	£1,855.00
1200	x	1660	1012 x 1200	30	900	1K1200.16601	£1,713.00	1K1200.16602	£1,770.00	1K1200.16603	£2,063.00	1K1200.16604	£2,013.00
1500	x	900	1112 x 500	19	1000	1K1500.09001	£1,365.00	1K1500.09002	£1,427.00	1K1500.09003	£1,732.00	1K1500.09004	£1,684.00
1500	x	1200	1112 x 900	23	1000	1K1500.12001	£1,599.00	1K1500.12002	£1,661.00	1K1500.12003	£1,966.00	1K1500.12004	£1,919.00
1500	x	1660	1112 x 1200	30	1000	1K1500.16601	£1,758.00	1K1500.16602	£1,820.00	1K1500.16603	£2,125.00	1K1500.16604	£2,078.00
1650	x	900	1312 x 500	19	1200	1K1650.09001	£1,544.00	1K1650.09002	£1,593.00	1K1650.09003	£1,923.00	1K1650.09004	£1,623.00
1650	x	1200	1312 x 900	23	1200	1K1650.12001	£1,820.00	1K1650.12002	£1,869.00	1K1650.12003	£2,198.00	1K1650.12004	£1,898.00
1650	x	1660	1312 x 1200	30	1200	1K1650.16601	£1,992.00	1K1650.16602	£2,043.00	1K1650.16603	£2,371.00	1K1650.16604	£2,072.00
1800	x	900	1509 x 500	19	1400	1K1800.09001	£1,946.00	1K1800.09002	£2,028.00	1K1800.09003	£2,585.00	1K1800.09004	£2,462.00
1800	x	1200	1509 x 900	23	1400	1K1800.12001	£2,262.00	1K1800.12002	£2,345.00	1K1800.12003	£2,902.00	1K1800.12004	£2,779.00
1800	x	1660	1509 x 1200	30	1400	1K1800.16601	£2,450.00	1K1800.16602	£2,533.00	1K1800.16603	£3,089.00	1K1800.16604	£2,966.00
2000	x	900	1709 x 500	19	1600	1K2000.09001	£2,057.00	1K2000.09002	£2,157.00	1K2000.09003	£2,702.00	1K2000.09004	£2,608.00
2000	x	1200	1709 x 900	23	1600	1K2000.12001	£2,374.00	1K2000.12002	£2,474.00	1K2000.12003	£3,019.00	1K2000.12004	£2,925.00
2000	x	1660	1709 x 1200	30	1600	1K2000.16601	£2,562.00	1K2000.16602	£2,661.00	1K2000.16603	£3,207.00	1K2000.16604	£3,113.00
2250	x	900	1909 x 500	19	1800	1K2250.09001	£2,221.00	1K2250.09002	£2,333.00	1K2250.09003	£2,919.00	1K2250.09004	£2,819.00
2250	x	1200	1909 x 900	23	1800	1K2250.12001	£2,573.00	1K2250.12002	£2,685.00	1K2250.12003	£3,271.00	1K2250.12004	£3,172.00
2250	x	1660	1909 x 1200	30	1800	1K2250.16601	£2,811.00	1K2250.16602	£2,922.00	1K2250.16603	£3,509.00	1K2250.16604	£3,409.00



Linear Drain Strainer  
 Order Ref  
**WM1810.0010**  
 Page 110



Hook  
 Order Ref  
**WM1840.0000**  
 Page 110



Maintenance Kit  
 Order Ref  
**WMMK**  
 Page 109



Installation Kit  
 Order Ref  
**WMIKU**  
 Page 109



Tanking Kit  
 Order Ref  
**WMVS30K**  
 Page 90

# UniSlope® | 1 K

## ALL KITS INCLUDE

A DRAIN – 48LTR / MIN  
 PVD DURABLE COATING  
 PREFORMED SLOPE BOARD  
 8m<sup>2</sup> WATERPROOFING SYSTEM



Wall Mounted Drain



Preformed Slope



Waterproofing kit

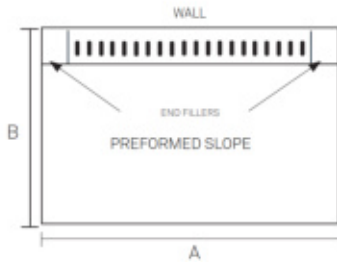

## DESIGN OPTION WITHOUT FRAME



Size		Minimum	Board	Drain	Brass	RRP Ex VAT	Copper	RRP Ex VAT	Black	RRP Ex VAT	Polished Stainless	RRP Ex VAT
A	B	Size	Height	Model	Kit Order Ref	£	Kit Order Ref	£	Kit Order Ref	£	Steel Kit Order Ref	£
750	x 900	432 x 500	19	300	1K0750.09005NF	£1,145.00	1K0750.09006NF	£1,145.00	1K0750.09007NF	£1,160.00	1K0750.09008NF	£1,145.00
750	x 1200	432 x 900	23	300	1K0750.12005NF	£1,262.00	1K0750.12006NF	£1,262.00	1K0750.12007NF	£1,277.00	1K0750.12008NF	£1,262.00
750	x 1660	432 x 1200	30	300	1K0750.16605NF	£1,342.00	1K0750.16606NF	£1,342.00	1K0750.16607NF	£1,356.00	1K0750.16608NF	£1,342.00
900	x 900	812 x 500	19	700	1K0900.09005NF	£1,350.00	1K0900.09006NF	£1,350.00	1K0900.09007NF	£1,376.00	1K0900.09008NF	£1,350.00
900	x 1200	812 x 900	23	700	1K0900.12005NF	£1,508.00	1K0900.12006NF	£1,508.00	1K0900.12007NF	£1,535.00	1K0900.12008NF	£1,508.00
900	x 1660	812 x 1200	30	700	1K0900.16605NF	£1,602.00	1K0900.16606NF	£1,602.00	1K0900.16607NF	£1,629.00	1K0900.16608NF	£1,602.00
1000	x 900	912 x 500	19	800	1K1000.09005NF	£1,411.00	1K1000.09006NF	£1,411.00	1K1000.09007NF	£1,436.00	1K1000.09008NF	£1,411.00
1000	x 1200	912 x 900	23	800	1K1000.12005NF	£1,570.00	1K1000.12006NF	£1,570.00	1K1000.12007NF	£1,593.00	1K1000.12008NF	£1,570.00
1000	x 1660	912 x 1200	30	800	1K1000.16605NF	£1,664.00	1K1000.16606NF	£1,664.00	1K1000.16607NF	£1,687.00	1K1000.16608NF	£1,664.00
1200	x 900	1012 x 500	19	900	1K1200.09005NF	£1,538.00	1K1200.09006NF	£1,538.00	1K1200.09007NF	£1,561.00	1K1200.09008NF	£1,538.00
1200	x 1200	1012 x 900	23	900	1K1200.12005NF	£1,773.00	1K1200.12006NF	£1,773.00	1K1200.12007NF	£1,796.00	1K1200.12008NF	£1,773.00
1200	x 1660	1012 x 1200	30	900	1K1200.16605NF	£1,931.00	1K1200.16606NF	£1,931.00	1K1200.16607NF	£1,955.00	1K1200.16608NF	£1,931.00
1500	x 900	1112 x 500	19	1000	1K1500.09005NF	£1,585.00	1K1500.09006NF	£1,585.00	1K1500.09007NF	£1,608.00	1K1500.09008NF	£1,585.00
1500	x 1200	1112 x 900	23	1000	1K1500.12005NF	£1,820.00	1K1500.12006NF	£1,820.00	1K1500.12007NF	£1,843.00	1K1500.12008NF	£1,820.00
1500	x 1660	1112 x 1200	30	1000	1K1500.16605NF	£1,978.00	1K1500.16606NF	£1,978.00	1K1500.16607NF	£2,001.00	1K1500.16608NF	£1,978.00
1650	x 900	1509 x 500	19	1200	1K1650.09005NF	£1,752.00	1K1650.09006NF	£1,752.00	1K1650.09007NF	£1,784.00	1K1650.09008NF	£1,752.00
1650	x 1200	1509 x 900	23	1200	1K1650.12005NF	£2,028.00	1K1650.12006NF	£2,028.00	1K1650.12007NF	£2,060.00	1K1650.12008NF	£2,028.00
1650	x 1660	1509 x 1200	30	1200	1K1650.16605NF	£2,200.00	1K1650.16606NF	£2,200.00	1K1650.16607NF	£2,233.00	1K1650.16608NF	£2,200.00
1800	x 900	1509 x 500	19	1400	1K1800.09005NF	£2,297.00	1K1800.09006NF	£2,297.00	1K1800.09007NF	£2,351.00	1K1800.09008NF	£2,297.00
1800	x 1200	1509 x 900	23	1400	1K1800.12005NF	£2,614.00	1K1800.12006NF	£2,614.00	1K1800.12007NF	£2,667.00	1K1800.12008NF	£2,614.00
1800	x 1660	1509 x 1200	30	1400	1K1800.16605NF	£2,802.00	1K1800.16606NF	£2,802.00	1K1800.16607NF	£2,855.00	1K1800.16608NF	£2,802.00
2000	x 900	1709 x 500	19	1600	1K2000.09005NF	£2,474.00	1K2000.09006NF	£2,474.00	1K2000.09007NF	£2,520.00	1K2000.09008NF	£2,474.00
2000	x 1200	1709 x 900	23	1600	1K2000.12005NF	£2,790.00	1K2000.12006NF	£2,790.00	1K2000.12007NF	£2,838.00	1K2000.12008NF	£2,790.00
2000	x 1660	1709 x 1200	30	1600	1K2000.16605NF	£2,978.00	1K2000.16606NF	£2,978.00	1K2000.16607NF	£3,025.00	1K2000.16608NF	£2,978.00
2250	x 900	1909 x 500	19	1800	1K2250.09005NF	£2,656.00	1K2250.09006NF	£2,656.00	1K2250.09007NF	£2,702.00	1K2250.09008NF	£2,656.00
2250	x 1200	1909 x 900	23	1800	1K2250.12005NF	£3,007.00	1K2250.12006NF	£3,007.00	1K2250.12007NF	£3,055.00	1K2250.12008NF	£3,007.00
2250	x 1660	1909 x 1200	30	1800	1K2250.16605NF	£3,245.00	1K2250.16606NF	£3,245.00	1K2250.16607NF	£3,292.00	1K2250.16608NF	£3,245.00



Linear Drain Strainer  
 Order Ref  
**WM1810.0010**  
 Page 110



Hook  
 Order Ref  
**WM1840.0000**  
 Page 110



Maintenance Kit  
 Order Ref  
**WMMK**  
 Page 109



Installation Kit  
 Order Ref  
**WMIKU**  
 Page 109



Tanking Kit  
 Order Ref  
**WMVS30K**  
 Page 90

# UniSlope® | 1 K

## ALL KITS INCLUDE

A DRAIN – 48LTR / MIN  
 PVD DURABLE COATING  
 PREFORMED SLOPE BOARD  
 8m<sup>2</sup> WATERPROOFING SYSTEM



Wall Mounted Drain



Preformed Slope



Waterproofing kit

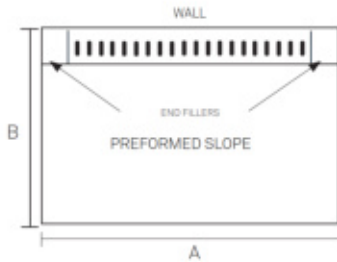

## DESIGN OPTION WITH FRAME



Size		Minimum	Board	Drain	Brass	RRP Ex VAT	Copper	RRP Ex VAT	Black	RRP Ex VAT	Polished Stainless	RRP Ex VAT			
A	B	Size	Height	Model	Kit Order Ref	£	Kit Order Ref	£	Kit Order Ref	£	Kit Order Ref	£			
750	x	900	432	x	500	19	300	1K0750.09005	£1,376.00	1K0750.09006	£1,376.00	1K0750.09007	£1,406.00	1K0750.09008	£1,376.00
750	x	1200	432	x	900	23	300	1K0750.12005	£1,494.00	1K0750.12006	£1,494.00	1K0750.12007	£1,527.00	1K0750.12008	£1,494.00
750	x	1660	432	x	1200	30	300	1K0750.16605	£1,573.00	1K0750.16606	£1,573.00	1K0750.16607	£1,605.00	1K0750.16608	£1,573.00
900	x	900	812	x	500	19	700	1K0900.09005	£1,729.00	1K0900.09006	£1,729.00	1K0900.09007	£1,784.00	1K0900.09008	£1,729.00
900	x	1200	812	x	900	23	700	1K0900.12005	£1,887.00	1K0900.12006	£1,887.00	1K0900.12007	£1,943.00	1K0900.12008	£1,887.00
900	x	1660	812	x	1200	30	700	1K0900.16605	£1,981.00	1K0900.16606	£1,981.00	1K0900.16607	£2,037.00	1K0900.16608	£1,981.00
1000	x	900	912	x	500	19	800	1K1000.09005	£1,802.00	1K1000.09006	£1,802.00	1K1000.09007	£1,855.00	1K1000.09008	£1,802.00
1000	x	1200	912	x	900	23	800	1K1000.12005	£1,960.00	1K1000.12006	£1,960.00	1K1000.12007	£2,013.00	1K1000.12008	£1,960.00
1000	x	1660	912	x	1200	30	800	1K1000.16605	£2,054.00	1K1000.16606	£2,054.00	1K1000.16607	£2,107.00	1K1000.16608	£2,054.00
1200	x	900	1012	x	500	19	900	1K1200.09005	£1,949.00	1K1200.09006	£1,949.00	1K1200.09007	£2,001.00	1K1200.09008	£1,949.00
1200	x	1200	1012	x	900	23	900	1K1200.12005	£2,183.00	1K1200.12006	£2,183.00	1K1200.12007	£2,236.00	1K1200.12008	£2,183.00
1200	x	1660	1012	x	1200	30	900	1K1200.16605	£2,342.00	1K1200.16606	£2,342.00	1K1200.16607	£2,394.00	1K1200.16608	£2,342.00
1500	x	900	1112	x	500	19	1000	1K1500.09005	£2,160.00	1K1500.09006	£2,160.00	1K1500.09007	£2,225.00	1K1500.09008	£2,160.00
1500	x	1200	1112	x	900	23	1000	1K1500.12005	£2,394.00	1K1500.12006	£2,394.00	1K1500.12007	£2,459.00	1K1500.12008	£2,394.00
1500	x	1660	1112	x	1200	30	1000	1K1500.16605	£2,553.00	1K1500.16606	£2,553.00	1K1500.16607	£2,617.00	1K1500.16608	£2,553.00
1650	x	900	1509	x	500	19	1200	1K1650.09005	£2,614.00	1K1650.09006	£2,359.00	1K1650.09007	£2,433.00	1K1650.09008	£2,359.00
1650	x	1200	1509	x	900	23	1200	1K1650.12005	£2,890.00	1K1650.12006	£2,635.00	1K1650.12007	£2,708.00	1K1650.12008	£2,635.00
1650	x	1660	1509	x	1200	30	1200	1K1650.16605	£3,063.00	1K1650.16606	£2,808.00	1K1650.16607	£2,881.00	1K1650.16608	£2,808.00
1800	x	900	1509	x	500	19	1400	1K1800.09005	£3,055.00	1K1800.09006	£3,055.00	1K1800.09007	£3,166.00	1K1800.09008	£3,055.00
1800	x	1200	1509	x	900	23	1400	1K1800.12005	£3,371.00	1K1800.12006	£3,371.00	1K1800.12007	£3,483.00	1K1800.12008	£3,371.00
1800	x	1660	1509	x	1200	30	1400	1K1800.16605	£3,559.00	1K1800.16606	£3,559.00	1K1800.16607	£3,670.00	1K1800.16608	£3,559.00
2000	x	900	1709	x	500	19	1600	1K2000.09005	£3,254.00	1K2000.09006	£3,254.00	1K2000.09007	£3,360.00	1K2000.09008	£3,254.00
2000	x	1200	1709	x	900	23	1600	1K2000.12005	£3,571.00	1K2000.12006	£3,571.00	1K2000.12007	£3,676.00	1K2000.12008	£3,571.00
2000	x	1660	1709	x	1200	30	1600	1K2000.16605	£3,759.00	1K2000.16606	£3,759.00	1K2000.16607	£3,864.00	1K2000.16608	£3,759.00
2250	x	900	1909	x	500	19	1800	1K2250.09005	£3,477.00	1K2250.09006	£3,477.00	1K2250.09007	£3,582.00	1K2250.09008	£3,477.00
2250	x	1200	1909	x	900	23	1800	1K2250.12005	£3,828.00	1K2250.12006	£3,828.00	1K2250.12007	£3,934.00	1K2250.12008	£3,828.00
2250	x	1660	1909	x	1200	30	1800	1K2250.16605	£4,066.00	1K2250.16606	£4,066.00	1K2250.16607	£4,172.00	1K2250.16608	£4,066.00



Linear Drain Strainer  
 Order Ref  
**WM1810.0010**  
 Page 110



Hook  
 Order Ref  
**WM1840.0000**  
 Page 110



Maintenance Kit  
 Order Ref  
**WMMK**  
 Page 109



Installation Kit  
 Order Ref  
**WMIKU**  
 Page 109



Tanking Kit  
 Order Ref  
**WMVS30K**  
 Page 90

# UniSlope® | 2K

## ALL KITS INCLUDE

A DRAIN – 48LTR / MIN  
 PREFORMED SLOPE BOARD  
 8m<sup>2</sup> WATERPROOFING SYSTEM



Corner Drain



Preformed Slope



Waterproofing kit

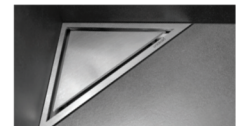
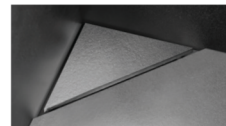
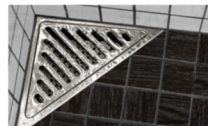
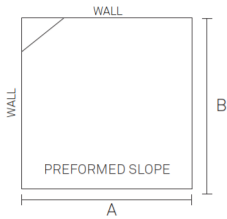

Size A	Size B	Minimum Size	Board Height	Drain Model	Classic Grate Kit Order Ref	RRP Ex VAT £	Column Grate Kit Order Ref	RRP Ex VAT £	Highline Custom Kit Order Ref	RRP Ex VAT £	Highline Panel Kit Order Ref	RRP Ex VAT £
900	x 900	500 x 500	19	Corner	2K0900.09001	£1,119.00	2K0900.09011	£1,119.00	2K0900.09002	£1,146.00	2K0900.09003	£1,280.00



Corner Drain Strainer  
 Order Ref  
**WM1810.0010**  
 Page 110



Hook  
 Order Ref  
**WM1840.0000**  
 Page 110



Maintenance Kit  
 Order Ref  
**WMMK**  
 Page 109



Installation Kit  
 Order Ref  
**WMIKU**  
 Page 109



Tanking Kit  
 Order Ref  
**WMVS30K**  
 Page 90

# UniSlope® | 3K

## ALL KITS INCLUDE

A DRAIN – 48LTR / MIN  
 PVD DURABLE COATING  
 PREFORMED SLOPE BOARD  
 8m<sup>2</sup> WATERPROOFING SYSTEM



Centre Drain

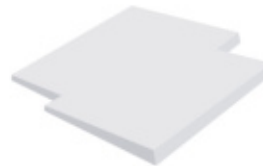

Preformed Slope



Waterproofing kit

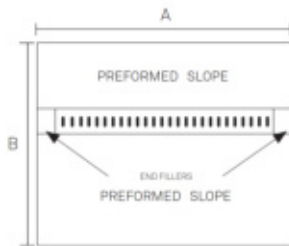

## DESIGN OPTIONS



Size		Minimum Size	Board Height	Drain Model	Anniversario Grate Kit Order Ref	RRP Ex VAT £	Highline Custom Kit Order Ref	RRP Ex VAT £	Highline Panel Kit Order Ref	RRP Ex VAT £	Highline Cassette Kit Order Ref	RRP Ex VAT £
A	B											
1000	x 1728	812 x 500	19	700	3K1000.17281	£1,424.00	3K1000.17282	£1,447.00	3K1000.17283	£1,755.00	3K1000.17284	£1,693.00
1000	x 2028	812 x 1728	23	700	3K1000.20281	£1,579.00	3K1000.20282	£1,602.00	3K1000.20283	£1,910.00	3K1000.20284	£1,849.00
1000	x 2488	812 x 2028	30	700	3K1000.24881	£1,673.00	3K1000.24882	£1,696.00	3K1000.24883	£2,004.00	3K1000.24884	£1,943.00
1500	x 1728	1312 x 500	19	1200	3K1500.17281	£1,881.00	3K1500.17282	£1,907.00	3K1500.17283	£2,283.00	3K1500.17284	£2,239.00
1500	x 2028	1312 x 1728	23	1200	3K1500.20281	£2,109.00	3K1500.20282	£2,137.00	3K1500.20283	£2,511.00	3K1500.20284	£2,468.00
1500	x 2488	1312 x 2028	30	1200	3K1500.24881	£2,268.00	3K1500.24882	£2,294.00	3K1500.24883	£2,670.00	3K1500.24884	£2,626.00

## DESIGN OPTIONS WITHOUT FRAME



Size		Minimum Size	Board Height	Drain Model	Brass		Copper		Black		Polished Stainless	
A	B				Kit Order Ref	RRP Ex VAT £	Kit Order Ref	RRP Ex VAT £	Kit Order Ref	RRP Ex VAT £	Kit Order Ref	RRP Ex VAT £
1000	x 1728	812 x 500	19	700	3K1000.17285NF	£1,582.00	3K1000.17286NF	£1,582.00	3K1000.17287NF	£1,608.00	3K1000.17288NF	£1,582.00
1000	x 2028	812 x 1728	23	700	3K1000.20285NF	£1,738.00	3K1000.20286NF	£1,738.00	3K1000.20287NF	£1,764.00	3K1000.20288NF	£1,738.00
1000	x 2488	812 x 2028	30	700	3K1000.24885NF	£1,832.00	3K1000.24886NF	£1,832.00	3K1000.24887NF	£1,858.00	3K1000.24888NF	£1,832.00
1500	x 1728	1312 x 500	19	1200	3K1500.17285NF	£2,066.00	3K1500.17286NF	£2,066.00	3K1500.17287NF	£2,098.00	3K1500.17288NF	£2,066.00
1500	x 2028	1312 x 1728	23	1200	3K1500.20285NF	£2,294.00	3K1500.20286NF	£2,294.00	3K1500.20287NF	£2,327.00	3K1500.20288NF	£2,294.00
1500	x 2488	1312 x 2028	30	1200	3K1500.24885NF	£2,453.00	3K1500.24886NF	£2,453.00	3K1500.24887NF	£2,485.00	3K1500.24888NF	£2,453.00



Linear Drain Strainer  
 Order Ref  
**WM1810.0010**  
 Page 110



Hook  
 Order Ref  
**WM1840.0000**  
 Page 110



Maintenance Kit  
 Order Ref  
**WMMK**  
 Page 109



Installation Kit  
 Order Ref  
**WMIKU**  
 Page 109



Tanking Kit  
 Order Ref  
**WMVS30K**  
 Page 90

# UniSlope® | 4K

## ALL KITS INCLUDE

A DRAIN – 48LTR / MIN  
 PVD DURABLE COATING  
 PREFORMED SLOPE BOARD  
 8m<sup>2</sup> WATERPROOFING SYSTEM



Centre Drain



Preformed Slope



Waterproofing kit

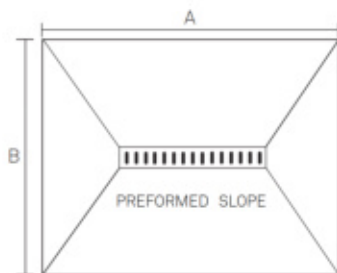

## DESIGN OPTIONS



Size		Minimum Size	Board Height	Drain Model	Anniversario Grate	RRP Ex VAT	Highline Custom	RRP Ex VAT	Highline Panel	RRP Ex VAT	Highline Cassette	RRP Ex VAT
A	B				Kit Order Ref	£	Kit Order Ref	£	Kit Order Ref	£	Kit Order Ref	£
900 x	900	800 x 600	19	300	4K0900.09001	£1,156.00	4K0900.09002	£1,150.00	4K0900.09003	£1,379.00	4K0900.09004	£1,332.00
1200 x	900	900 x 600	19	700	4K1200.09001	£1,281.00	4K1200.09002	£1,302.00	4K1200.09003	£1,582.00	4K1200.09004	£1,527.00
1500 x	1000	1200 x 600	19	700	4K1500.10001	£1,260.00	4K1500.10002	£1,281.00	4K1500.10003	£1,561.00	4K1500.10004	£1,504.00

## DESIGN OPTION WITHOUT FRAME

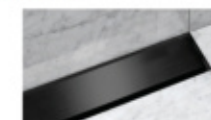

Size		Minimum Size	Board Height	Drain Model	Brass	RRP Ex VAT	Copper	RRP Ex VAT	Black	RRP Ex VAT	Polished Stainless	RRP Ex VAT
A	B				Kit Order Ref	£	Kit Order Ref	£	Kit Order Ref	£	Kit Order Ref	£
900 x	900	800 x 600	19	300	4K0900.09005NF	£1,252.00	4K0900.09006NF	£1,252.00	4K0900.09007NF	£1,265.00	4K0900.09008NF	£1,252.00
1200 x	900	900 x 600	19	700	4K1200.09005NF	£1,425.00	4K1200.09006NF	£1,425.00	4K1200.09007NF	£1,486.00	4K1200.09008NF	£1,425.00
1500 x	1000	1200 x 600	19	700	4K1500.10005NF	£1,403.00	4K1500.10006NF	£1,403.00	4K1500.10007NF	£1,465.00	4K1500.10008NF	£1,403.00



Linear Drain Strainer  
 Order Ref  
**WM1810.0010**  
 Page 110



Hook  
 Order Ref  
**WM1840.0000**  
 Page 110



Maintenance Kit  
 Order Ref  
**WMMK**  
 Page 109



Installation Kit  
 Order Ref  
**WMIKU**  
 Page 109



Tanking Kit  
 Order Ref  
**WMVS30K**  
 Page 90

# UNIDRIAN GLASSLINE

GLASSLINE BASE. GLASS SOLD SEPARATELY.



## RIGHT-ALIGNED SHOWER SCREEN DESIGN OPTIONS



A	B	Drain Depth	Anniversario Grate Kit Order Ref	RRP Ex VAT £	Highline Custom Kit Order Ref	RRP Ex VAT £	Highline Panel Kit Order Ref	RRP Ex VAT £	Highline Cassette Kit Order Ref	RRP Ex VAT £
800	800	105	5002.0808K1	£1,277.00	5002.0808K2	£1,327.00	5002.0808K3	£1,599.00	5002.0808K4	£1,553.00
800	900	105	5002.0809K1	£1,315.00	5002.0809K2	£1,365.00	5002.0809K3	£1,638.00	5002.0809K4	£1,590.00
800	1000	105	5002.0810K1	£1,321.00	5002.0810K2	£1,371.00	5002.0810K3	£1,644.00	5002.0810K4	£1,596.00
800	1200	105	5002.0812K1	£1,374.00	5002.0812K2	£1,424.00	5002.0812K3	£1,696.00	5002.0812K4	£1,650.00
900	800	106	5002.0908K1	£1,321.00	5002.0908K2	£1,376.00	5002.0908K3	£1,670.00	5002.0908K4	£1,621.00
900	900	106	5002.0909K1	£1,321.00	5002.0909K2	£1,376.00	5002.0909K3	£1,670.00	5002.0909K4	£1,621.00
900	1000	106	5002.0910K1	£1,327.00	5002.0910K2	£1,382.00	5002.0910K3	£1,676.00	5002.0910K4	£1,626.00
900	1200	106	5002.0912K1	£1,379.00	5002.0912K2	£1,436.00	5002.0912K3	£1,729.00	5002.0912K4	£1,679.00
1000	900	108	5002.1009K1	£1,374.00	5002.1009K2	£1,436.00	5002.1009K3	£1,741.00	5002.1009K4	£1,693.00
1000	1000	108	5002.1010K1	£1,385.00	5002.1010K2	£1,447.00	5002.1010K3	£1,752.00	5002.1010K4	£1,705.00
1000	1200	108	5002.1012K1	£1,499.00	5002.1012K2	£1,561.00	5002.1012K3	£1,866.00	5002.1012K4	£1,820.00



## LEFT-ALIGNED SHOWER SCREEN DESIGN OPTIONS



A	B	Drain Depth	Anniversario Grate Kit Order Ref	RRP Ex VAT £	Highline Custom Kit Order Ref	RRP Ex VAT £	Highline Panel Kit Order Ref	RRP Ex VAT £	Highline Cassette Kit Order Ref	RRP Ex VAT £
800	800	105	5003.0808K1	£1,277.00	5003.0808K2	£1,327.00	5003.0808K3	£1,599.00	5003.0808K4	£1,553.00
800	900	105	5003.0809K1	£1,315.00	5003.0809K2	£1,365.00	5003.0809K3	£1,638.00	5003.0809K4	£1,590.00
800	1000	105	5003.0810K1	£1,321.00	5003.0810K2	£1,371.00	5003.0810K3	£1,644.00	5003.0810K4	£1,596.00
800	1200	105	5003.0812K1	£1,374.00	5003.0812K2	£1,424.00	5003.0812K3	£1,696.00	5003.0812K4	£1,650.00
900	800	106	5003.0908K1	£1,321.00	5003.0908K2	£1,376.00	5003.0908K3	£1,670.00	5003.0908K4	£1,621.00
900	900	106	5003.0909K1	£1,321.00	5003.0909K2	£1,376.00	5003.0909K3	£1,670.00	5003.0909K4	£1,621.00
900	1000	106	5003.0910K1	£1,327.00	5003.0910K2	£1,382.00	5003.0910K3	£1,676.00	5003.0910K4	£1,626.00
900	1200	106	5003.0912K1	£1,379.00	5003.0912K2	£1,436.00	5003.0912K3	£1,729.00	5003.0912K4	£1,679.00
1000	900	108	5003.1009K1	£1,374.00	5003.1009K2	£1,436.00	5003.1009K3	£1,741.00	5003.1009K4	£1,693.00
1000	1000	108	5003.1010K1	£1,385.00	5003.1010K2	£1,447.00	5003.1010K3	£1,752.00	5003.1010K4	£1,705.00
1000	1200	108	5003.1012K1	£1,499.00	5003.1012K2	£1,561.00	5003.1012K3	£1,866.00	5003.1012K4	£1,820.00



# UNIDRIAN GLASSLINE

GLASSLINE BASE. GLASS SOLD SEPARATELY.



## RIGHT-ALIGNED SHOWER SCREEN DESIGN OPTIONS



A	B	Drain Depth	Brass		Copper		Black		Polished Stainless Steel	
			Highline Panel Kit Order Ref	RRP Ex VAT £	Highline Panel Kit Order Ref	RRP Ex VAT £	Highline Panel Kit Order Ref	RRP Ex VAT £	Highline Panel Kit Order Ref	RRP Ex VAT £
800	800	105	5002.0808K5	£1,875.00	5002.0808K6	£1,875.00	5002.0808K7	£1,928.00	5002.0808K8	£1,875.00
800	900	105	5002.0809K5	£1,913.00	5002.0809K6	£1,913.00	5002.0809K7	£1,926.00	5002.0809K8	£1,913.00
800	1000	105	5002.0810K5	£1,919.00	5002.0810K6	£1,919.00	5002.0810K7	£1,972.00	5002.0810K8	£1,919.00
800	1200	105	5002.0812K5	£1,972.00	5002.0812K6	£1,972.00	5002.0812K7	£2,025.00	5002.0812K8	£1,972.00
900	800	106	5002.0908K5	£1,949.00	5002.0908K6	£1,949.00	5002.0908K7	£2,001.00	5002.0908K8	£1,949.00
900	900	106	5002.0909K5	£1,949.00	5002.0909K6	£1,949.00	5002.0909K7	£2,001.00	5002.0909K8	£1,949.00
900	1000	106	5002.0910K5	£1,955.00	5002.0910K6	£1,955.00	5002.0910K7	£2,007.00	5002.0910K8	£1,955.00
900	1200	106	5002.0912K5	£2,007.00	5002.0912K6	£2,007.00	5002.0912K7	£2,060.00	5002.0912K8	£2,007.00
1000	900	108	5002.1009K5	£2,169.00	5002.1009K6	£2,169.00	5002.1009K7	£2,233.00	5002.1009K8	£2,169.00
1000	1000	108	5002.1010K5	£2,180.00	5002.1010K6	£2,180.00	5002.1010K7	£2,245.00	5002.1010K8	£2,180.00
1000	1200	108	5002.1012K5	£2,294.00	5002.1012K6	£2,294.00	5002.1012K7	£2,359.00	5002.1012K8	£2,294.00



## LEFT-ALIGNED SHOWER SCREEN DESIGN OPTIONS



A	B	Drain Depth	Brass		Copper		Black		Polished Stainless Steel	
			Highline Panel Kit Order Ref	RRP Ex VAT £	Highline Panel Kit Order Ref	RRP Ex VAT £	Highline Panel Kit Order Ref	RRP Ex VAT £	Highline Panel Kit Order Ref	RRP Ex VAT £
800	800	105	5003.0808K5	£1,875.00	5003.0808K6	£1,875.00	5003.0808K7	£1,928.00	5003.0808K8	£1,875.00
800	900	105	5003.0809K5	£1,913.00	5003.0809K6	£1,913.00	5003.0809K7	£1,926.00	5003.0809K8	£1,913.00
800	1000	105	5003.0810K5	£1,919.00	5003.0810K6	£1,919.00	5003.0810K7	£1,972.00	5003.0810K8	£1,919.00
800	1200	105	5003.0812K5	£1,972.00	5003.0812K6	£1,972.00	5003.0812K7	£2,025.00	5003.0812K8	£1,972.00
900	800	106	5003.0908K5	£1,949.00	5003.0908K6	£1,949.00	5003.0908K7	£2,001.00	5003.0908K8	£1,949.00
900	900	106	5003.0909K5	£1,949.00	5003.0909K6	£1,949.00	5003.0909K7	£2,001.00	5003.0909K8	£1,949.00
900	1000	106	5003.0910K5	£1,955.00	5003.0910K6	£1,955.00	5003.0910K7	£2,007.00	5003.0910K8	£1,955.00
900	1200	106	5003.0912K5	£2,007.00	5003.0912K6	£2,007.00	5003.0912K7	£2,060.00	5003.0912K8	£2,007.00
1000	900	108	5003.1009K5	£2,169.00	5003.1009K6	£2,169.00	5003.1009K7	£2,233.00	5003.1009K8	£2,169.00
1000	1000	108	5003.1010K5	£2,180.00	5003.1010K6	£2,180.00	5003.1010K7	£2,245.00	5003.1010K8	£2,180.00
1000	1200	108	5003.1012K5	£2,294.00	5003.1012K6	£2,294.00	5003.1012K7	£2,359.00	5003.1012K8	£2,294.00

# UNIDRIAN GLASSLINE



BLACK POWDER COATED FRAME



CAN BE RIGHT- OR LEFT-ALIGNED

A	B		
Shower Screen	Shower Screen Height	Black Kit Order Ref	RRP Ex Vat £
800	2104	5117.0800	£1,019.00
900	2104	5117.0900	£1,054.00
1000	2104	5117.1000	£1,089.00
1200	2104	n/a	



STAINLESS STEEL



CAN BE RIGHT- OR LEFT-ALIGNED

A	B		
Shower Screen	Shower Screen Height	Transparent Kit Order Ref	RRP Ex Vat £
800	2104	5100.0800	£1,136.00
900	2104	5100.0900	£1,174.00
1000	2104	5100.1000	£1,408.00
1200	2104	5100.1200	£1,559.00

## UNIDRIAN GLASSLINE ACCESSORIES



Model No	Glass Door Order Ref	RRP Ex Vat £
800	5400.0800	£951.00
900	5400.0900	£1,013.00
1000	5400.1000	£1,089.00



Model No	Right Bar Order Ref	Left Bar Order Ref	RRP Ex Vat £
700	5310.1202	5310.1203	£619.00
800	5310.1202	5310.1203	£619.00
900	5310.1202	5310.1203	£619.00
1000	5310.1202	5310.1203	£619.00
1200	5310.1202	5310.1203	£619.00

# UNIDRIAN SHOWERLINE

RIGHT-ALIGNED SHOWER SCREEN

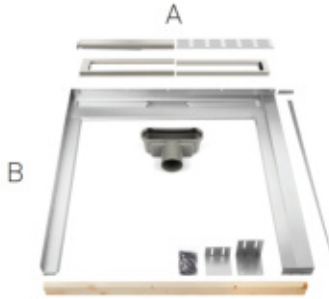

LEFT-ALIGNED SHOWER SCREEN

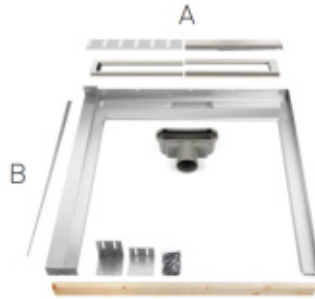

RIGHT-ALIGNED SHOWER SCREEN

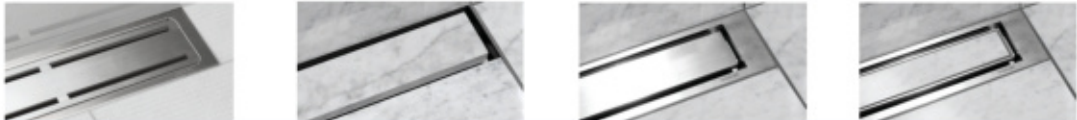

A Drain Size	B Shower Screen	Depth	Anniversario Grate Kit Order Ref	RRP Ex VAT £	Highline Custom Kit Order Ref	RRP Ex VAT £	Highline Panel Kit Order Ref	RRP Ex VAT £	Highline Cassette Kit Order Ref	RRP Ex VAT £
800	900	105	5022.0809K1	£1,315.00	5022.0809K2	£1,365.00	5022.0809K3	£1,638.00	5022.0809K4	£1,590.00
900	900	106	5022.0909K1	£1,321.00	5022.0909K2	£1,376.00	5022.0909K3	£1,670.00	5022.0909K4	£1,621.00



A Drain Size	B Shower Screen	Depth	Brass Highline Panel Kit Order Ref	RRP Ex VAT £	Copper Highline Panel Kit Order Ref	RRP Ex VAT £	Black Highline Panel Kit Order Ref	RRP Ex VAT £	Polished Stainless Steel Highline Panel Kit Order Ref	RRP Ex VAT £
800	900	105	5022.0809K5	£1,913.00	5022.0809K6	£1,913.00	5022.0809K7	£1,966.00	5022.0809K8	£1,913.00
900	900	106	5022.0909K5	£1,949.00	5022.0909K6	£1,949.00	5022.0909K7	£2,001.00	5022.0909K8	£1,949.00

LEFT-ALIGNED SHOWER SCREEN



A Drain Size	B Shower Screen	Depth	Anniversario Grate Kit Order Ref	RRP Ex VAT £	Highline Custom Kit Order Ref	RRP Ex VAT £	Highline Panel Kit Order Ref	RRP Ex VAT £	Highline Cassette Kit Order Ref	RRP Ex VAT £
800	900	105	5023.0809K1	£1,315.00	5023.0809K2	£1,365.00	5023.0809K3	£1,638.00	5023.0809K4	£1,590.00
900	900	106	5023.0909K1	£1,321.00	5023.0909K2	£1,376.00	5023.0909K3	£1,670.00	5023.0909K4	£1,621.00



A Drain Size	B Shower Screen	Depth	Brass Highline Panel Kit Order Ref	RRP Ex VAT £	Copper Highline Panel Kit Order Ref	RRP Ex VAT £	Black Highline Panel Kit Order Ref	RRP Ex VAT £	Polished Stainless Steel Highline Panel Kit Order Ref	RRP Ex VAT £
800	900	105	5023.0809K5	£1,913.00	5023.0809K6	£1,913.00	5023.0809K7	£1,966.00	5023.0809K8	£1,913.00
900	900	106	5023.0909K5	£1,949.00	5023.0909K6	£1,949.00	5023.0909K7	£2,001.00	5023.0909K8	£1,949.00

# WALL MOUNTED UNIDRAIN®

## CLASSICLINE

Model No	A Structural Length	B Visual Length	C Drain Depth	Classicline Kit Order Ref	RRP Ex VAT £
300	432	300	98	1004.0300K1	£470.00
600	712	600	102	1004.0600K1	£584.00
700	812	700	103	1004.0700K1	£584.00
800	912	800	104	1004.0800K1	£614.00
900	1012	900	105	1004.0900K1	£641.00
1000	1112	1000	106	1004.1000K1	£684.00
1200	1312	1200	108	1004.1200K1	£828.00
1400	1509	1400	103	1004.1400K1	£1,424.00
1600	1709	1600	104	1004.1600K1	£1,535.00
1800	1909	1800	105	1004.1800K1	£1,635.00

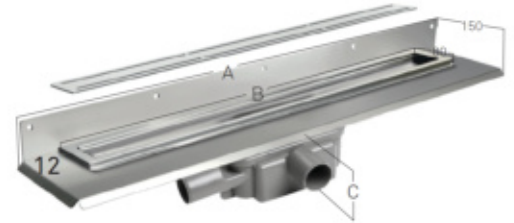

## CHOOSE YOUR GRATE STYLE



Anniversario  
Standard Grate



Classic



Column



Inca



Square



Stripe

# WALL MOUNTED UNIDRAIN®

## HIGHLINE CUSTOM



Model No	A Structural Length	B Base Length	C Drain Depth	HighLine Custom Kit Order Ref	RRP Ex VAT £
300	432	253	98	1004.0300K2	£479.00
600	712	533	102	1004.0600K2	£626.00
700	812	633	103	1004.0700K2	£626.00
800	912	733	104	1004.0800K2	£664.00
900	1012	833	105	1004.0900K2	£696.00
1000	1112	933	106	1004.1000K2	£746.00
1200	1312	1133	108	1004.1200K2	£878.00
1400	1509	633 x 2	103	1004.1400K2	£1,505.00
1600	1709	733 x 2	104	1004.1600K2	£1,635.00
1800	1909	833 x 2	105	1004.1800K2	£1,746.00

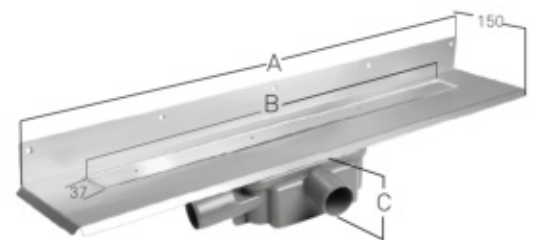

Linear Drain Strainer  
Order Ref  
WM1810.0010  
Page 110



Hook  
Order Ref  
WM1840.0000  
Page 110



Maintenance Kit  
Order Ref  
WMMK  
Page 109



Installation Kit  
Order Ref  
WMIKU  
Page 109



Tanking Kit  
Order Ref  
WMVS30K  
Page 90

# WALL MOUNTED UNIDRAIN®

## HIGHLINE PANEL



Model No	A Structural Length	B Visual Length	C Drain Depth	Highline Brushed Stainless Steel		Highline Brass	
				Panel Kit Order Ref	RRP Ex Vat £	Panel Kit Order Ref	RRP Ex Vat £
300	432	300	98	1004.0300K3	£711.00	1004.0300K5	£823.00
700	812	700	103	1004.0700K3	£904.00	1004.0700K5	£1,139.00
800	912	800	104	1004.0800K3	£937.00	1004.0800K5	£1,212.00
900	1012	900	105	1004.0900K3	£989.00	1004.0900K5	£1,268.00
1000	1112	1000	106	1004.1000K3	£1,051.00	1004.1000K5	£1,479.00
1200	1312	1200	108	1004.1200K3	£1,206.00	1004.1200K5	£1,644.00
1400	1509	1400	103	1004.1400K3	£2,063.00	1004.1400K5	£2,533.00
1600	1709	1600	104	1004.1600K3	£2,180.00	1004.1600K5	£2,732.00
1800	1909	1800	105	1004.1800K3	£2,333.00	1004.1800K5	£2,890.00

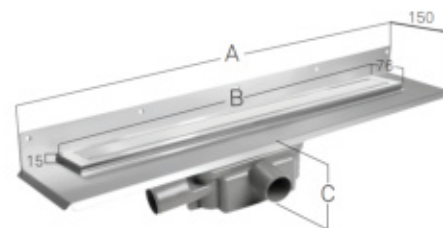

Model No	A Structural Length	B Visual Length	C Drain Depth	Highline Copper		Highline Black		Highline Polished	
				Panel Kit Order Ref	RRP Ex Vat £	Panel Kit Order Ref	RRP Ex Vat £	Stainless Steel Panel Kit Order Ref	RRP Ex Vat £
300	432	300	98	1004.0300K6	£823.00	1004.0300K7	£855.00	1004.0300K8	£823.00
700	812	700	103	1004.0700K6	£1,139.00	1004.0700K7	£1,194.00	1004.0700K8	£1,139.00
800	912	800	104	1004.0800K6	£1,212.00	1004.0800K7	£1,265.00	1004.0800K8	£1,212.00
900	1012	900	105	1004.0900K6	£1,268.00	1004.0900K7	£1,321.00	1004.0900K8	£1,268.00
1000	1112	1000	106	1004.1000K6	£1,479.00	1004.1000K7	£1,544.00	1004.1000K8	£1,479.00
1200	1312	1200	108	1004.1200K6	£1,644.00	1004.1200K7	£1,716.00	1004.1200K8	£1,644.00
1400	1509	1400	103	1004.1400K6	£2,533.00	1004.1400K7	£2,644.00	1004.1400K8	£2,533.00
1600	1709	1600	104	1004.1600K6	£2,732.00	1004.1600K7	£2,838.00	1004.1600K8	£2,732.00
1800	1909	1800	105	1004.1800K6	£2,890.00	1004.1800K7	£2,995.00	1004.1800K8	£2,890.00



Linear Drain Strainer  
Order Ref  
**WM1810.0010**  
Page 110



Hook  
Order Ref  
**WM1840.0000**  
Page 110



Maintenance Kit  
Order Ref  
**WMMK**  
Page 109



Installation Kit  
Order Ref  
**WMIKU**  
Page 109



Tanking Kit  
Order Ref  
**WMVS30K**  
Page 90

# WALL MOUNTED UNIDRAIN®

## HIGHLINE CASSETTE



Model No	A Structural Length	B Visual Length	C Drain Depth	Highline Cassette Kit Order Ref	RRP Ex VAT £
300	432	300	98	1004.0300K4	£658.00
700	812	700	103	1004.0700K4	£843.00
800	912	800	104	1004.0800K4	£889.00
900	1012	900	105	1004.0900K4	£940.00
1000	1112	1000	106	1004.1000K4	£1,004.00
1200	1312	1200	108	1004.1200K4	£1,162.00
1400	1509	1400	103	1004.1400K4	£1,940.00
1600	1709	1600	104	1004.1600K4	£2,086.00
1800	1909	1800	105	1004.1800K4	£2,233.00

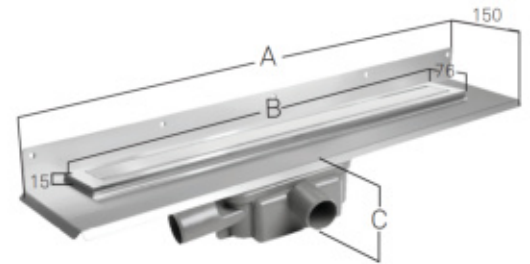

# WALL MOUNTED UNIDRAIN®

## CORNER DRAIN

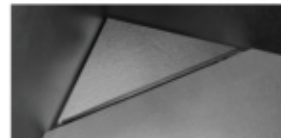
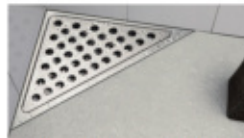
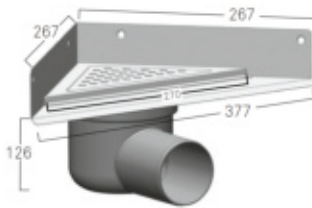

Model	Structural Length	Visual Length	Drain Depth	Classicline Kit Order Ref	RRP Ex VAT £	Highline Custom Kit Order Ref	RRP Ex VAT £	Highline Panel Kit Order Ref	RRP Ex VAT £
Corner	268	196	126	2001.0200K1	£461.00	2001.0200K2	£484.00	2001.0200K3	£623.00



Corner Drain Strainer  
Order Ref  
WM1810.0010  
Page 110



Linear Drain Strainer  
Order Ref  
WM1810.0010  
Page 110



Hook  
Order Ref  
WM1840.0000  
Page 110



Maintenance Kit  
Order Ref  
WMMK  
Page 109



Installation Kit  
Order Ref  
WMIKU  
Page 109



Tanking Kit  
Order Ref  
WMVS30K  
Page 90

# CENTRE FLOOR UNIDRAIN®

## CLASSICLINE

Model No	A Structural Length	B Visual Length	C Drain Depth	Classicline Kit Order Ref	RRP Ex VAT £
300	432	300	98	3004.0300K1	£481.00
700	812	700	103	3004.0700K1	£606.00
800	912	800	104	3004.0800K1	£638.00
900	1012	900	105	3004.0900K1	£678.00
1000	1112	1000	106	3004.1000K1	£742.00
1200	1312	1200	108	3004.1200K1	£849.00

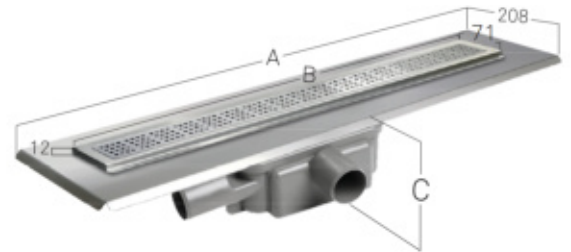

## CHOOSE YOUR GRATE STYLE



Anniversario  
Standard Grate



Classic



Column



Inca



Square



Stripe

# CENTRE FLOOR UNIDRAIN®

## HIGHLINE CUSTOM

Model No	A Structural Length	B Base Length	C Drain Depth	HighLine Custom Kit Order Ref	RRP Ex VAT £
300	432	253	98	3004.0300K2	£475.00
700	812	633	103	3004.0700K2	£628.00
800	912	733	104	3004.0800K2	£667.00
900	1012	833	105	3004.0900K2	£711.00
1000	1112	933	106	3004.1000K2	£782.00
1200	1312	1133	108	3004.1200K2	£873.00

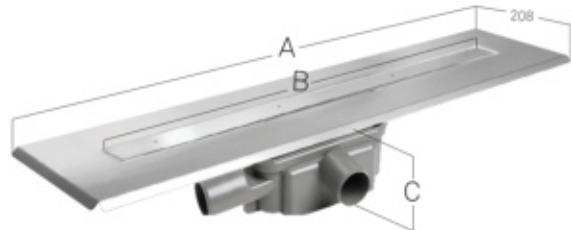

Linear Drain Strainer  
Order Ref  
WM1810.0010  
Page 110



Hook  
Order Ref  
WM1840.0000  
Page 110



Maintenance Kit  
Order Ref  
WMMK  
Page 109



Installation Kit  
Order Ref  
WMIKU  
Page 109



Tanking Kit  
Order Ref  
WMVS30K  
Page 90

# CENTRE FLOOR UNIDRAIN®

HIGHLINE PANEL WITHOUT FRAME



Model No	A Structural Length	B Visual Length	C Drain Depth	Highline Brushed Stainless Steel Panel		Highline Brass	
				Panel Kit Order Ref	RRP Ex Vat £	Panel Kit Order Ref	RRP Ex Vat £
300	432	253	98	3004.0300K3NF	£548.00	3004.0300K5NF	£577.00
700	812	633	103	3004.0700K3NF	£699.00	3004.0700K5NF	£750.00
800	912	733	104	3004.0800K3NF	£724.00	3004.0800K5NF	£812.00
900	1012	833	105	3004.0900K3NF	£771.00	3004.0900K5NF	£857.00
1000	1112	933	106	3004.1000K3NF	£838.00	3004.1000K5NF	£927.00
1200	1312	1133	108	3004.1200K3NF	£924.00	3004.1200K5NF	£1,017.00

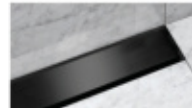
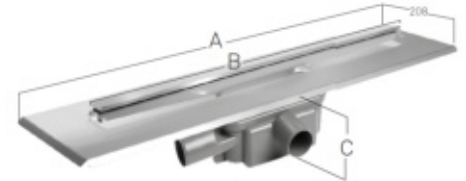

Model No	A Structural Length	B Visual Length	C Drain Depth	Highline Copper		Highline Black		Highline Polished Steel Panel	
				Panel Kit Order Ref	RRP Ex Vat £	Panel Kit Order Ref	RRP Ex Vat £	Panel Kit Order Ref	RRP Ex Vat £
300	432	253	98	3004.0300K6NF	£577.00	3004.0300K7NF	£590.00	3004.0300K8NF	£577.00
700	812	633	103	3004.0700K6NF	£750.00	3004.0700K7NF	£774.00	3004.0700K8NF	£750.00
800	912	733	104	3004.0800K6NF	£812.00	3004.0800K7NF	£833.00	3004.0800K8NF	£812.00
900	1012	833	105	3004.0900K6NF	£857.00	3004.0900K7NF	£878.00	3004.0900K8NF	£857.00
1000	1112	933	106	3004.1000K6NF	£927.00	3004.1000K7NF	£948.00	3004.1000K8NF	£927.00
1200	1312	1133	108	3004.1200K6NF	£1,017.00	3004.1200K7NF	£1,046.00	3004.1200K8NF	£1,017.00



Linear Drain Strainer  
Order Ref  
**WM1810.0010**  
Page 110



Hook  
Order Ref  
**WM1840.0000**  
Page 110



Maintenance Kit  
Order Ref  
**WMMK**  
Page 109



Installation Kit  
Order Ref  
**WMIKU**  
Page 109



Tanking Kit  
Order Ref  
**WMVS30K**  
Page 90



# CENTRE FLOOR UNIDRAIN®

## HIGHLINE PANEL WITH FRAME



Model No	A Structural Length	B Visual Length	C Drain Depth	HighLine Brushed Stainless Steel Panel Kit Order Ref	RRP Ex VAT £
300	432	300	98	3004.0300K3	£704.00
700	812	700	103	3004.0700K3	£907.00
800	912	800	104	3004.0800K3	£948.00
900	1012	900	105	3004.0900K3	£1,015.00
1000	1112	1000	106	3004.1000K3	£1,097.00
1200	1312	1200	108	3004.1200K3	£1,215.00

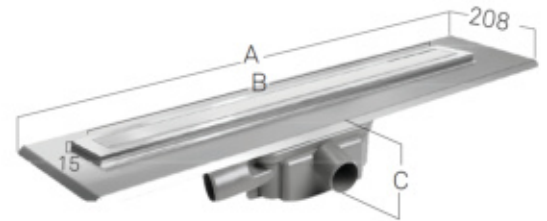

# CENTRE FLOOR UNIDRAIN®

## HIGHLINE CASSETTE



Model No	A Structural Length	B Visual Length	C Drain Depth	Highline Cassette Kit Order Ref	RRP Ex VAT £
300	432	300	98	3004.0300K4	£657.00
700	812	700	103	3004.0700K4	£852.00
800	912	800	104	3004.0800K4	£904.00
900	1012	900	105	3004.0900K4	£969.00
1000	1112	1000	106	3004.1000K4	£1,054.00
1200	1312	1200	108	3004.1200K4	£1,174.00

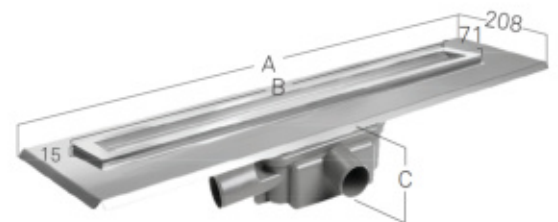

Linear Drain Strainer  
Order Ref  
**WM1810.0010**  
Page 110



Hook  
Order Ref  
**WM1840.0000**  
Page 110



Maintenance Kit  
Order Ref  
**WMMK**  
Page 109



Installation Kit  
Order Ref  
**WMIKU**  
Page 109



Tanking Kit  
Order Ref  
**WMVS30K**  
Page 90

# UNIDRAIN® SQUARE

Model No	A Structural Length	B Visual Length	C Drain Depth	Kit Order Ref	RRP Ex VAT £
WM810	314	100 x 100	116	WM82100	£362.00
WM815	314	150 x 150	116	WM82150	£373.00

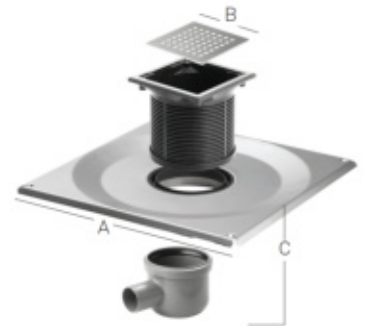

Model No	A Structural Length	B Visual Length	C Drain Depth	Kit Order Ref	RRP Ex VAT £
WM810V	314	100 x 100	116	WM82100V	£362.00
WM815V	314	150 x 150	116	WM82150V	£373.00

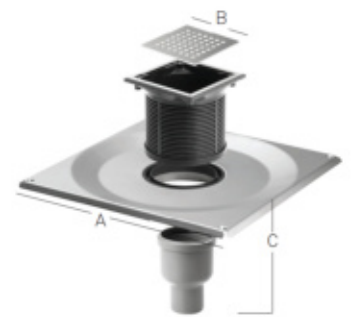

CHOOSE YOUR GRATE STYLE (100MM x 100MM & 150MM x 150MM)



Custom Base

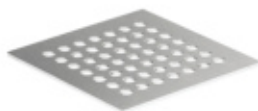

Classic

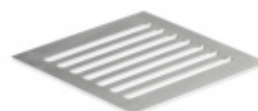

Column



Anniversario

Please check stock as some components have been discontinued

# UNIDRAIN® SQUARE

<b>A</b> Structural Length	<b>B</b> Visual Length	<b>C</b> Drain Depth	Kit Order Ref	RRP Ex VAT £
221	100 x 100	109-119	WM8021100	£362.00
221	150 x 150	109-119	WM8021150	£373.00

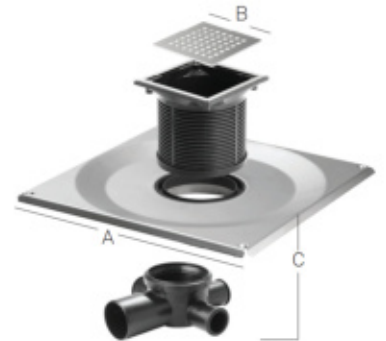

<b>A</b> Structural Length	<b>B</b> Visual Length	<b>C</b> Drain Depth	Kit Order Ref	RRP Ex VAT £
221	100 x 100	139 - 149	WM8022100V	£362.00
221	150 x 150	139-149	WM8022150V	£373.00

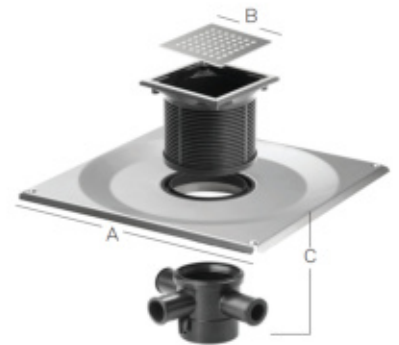

Custom Base

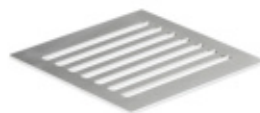

Column

# WETROOM MATERIALS

## CENTRE DRAIN



Vertical option available

	<b>A</b>	<b>B</b>	<b>C</b>		
Model No	Structural Length	Visual Length	Drain Depth	Centre Drain Kit Order Ref	RRP Ex VAT £
3159	215	200 x 200	59	PM059	£231.00

### CHOOSE YOUR GRATE STYLE



Art Deco



Classic



Drop

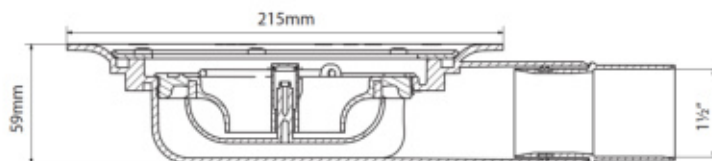

	<b>A</b>	<b>B</b>	<b>C</b>		
Model No	Structural Length	Visual Length	Drain Depth	Centre Drain Kit Order Ref	RRP Ex VAT £
3161	197	145 x 145	76	PM001	£126.00

### CHOOSE YOUR GRATE STYLE



Art Deco



Classic



Drop



Tile Insert

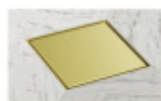
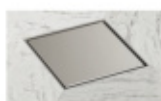
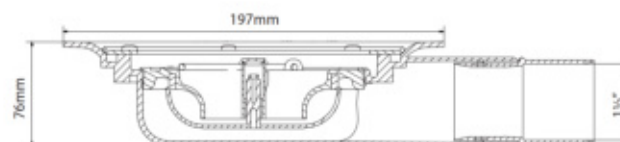

Steel Panel	RRP Ex VAT	Black Panel	RRP Ex VAT	Brass Panel	RRP Ex VAT	Nickel Panel	RRP Ex VAT	Bronze Panel	RRP Ex VAT
Kit Order Ref	£	Kit Order Ref	£	Kit Order Ref	£	Kit Order Ref	£	Kit Order Ref	£
SDSD.0076SS	£126.00	SDSD.0076BL	£336.00	SDSD.0076BS	£285.00	SDSD.0076NI	£285.00	SDSD.0076BZ	£285.00

# WETROOM MATERIALS

## CENTRE DRAIN



Plan View

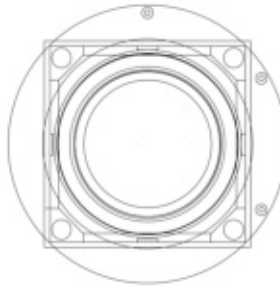

Side View

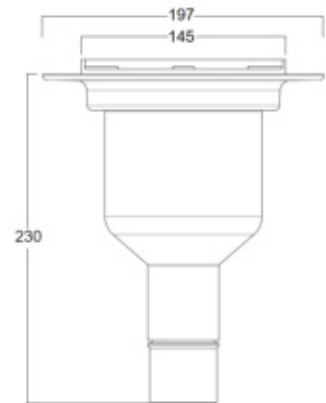

A	B	C	Centre Drain Kit Order Ref	RRP Ex VAT £
Structural Length	Visual Length	Drain Depth	WM189V	£117.00
197	145 x 145	230		

### CHOOSE YOUR GRATE STYLE



Art Deco



Classic



Drop



Tile Insert

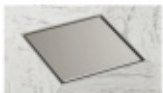

Steel Panel

RRP Ex VAT £

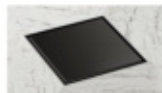

Black Panel

RRP Ex VAT £

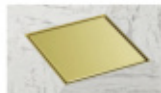

Brass Panel

RRP Ex VAT £

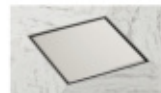

Nickel Panel

RRP Ex VAT £



Bronze Panel

RRP Ex VAT £

SDSD.0189SS

£133.00

SDSD.0189BL

£344.00

SDSD.0189BS

£294.00

SDSD.0189NI

£294.00

SDSD.0189BZ

£294.00

## LIP FOUNDATION MATERIALS

Product	Order Ref	RRP Ex Vat £
Waterproofing Membrane	WMVS30K	£139.00
Corner Piece (Internal)	WMICP	£13.00
Corner Piece (External)	WMECP	£13.00
Construction Glue	WMCG	£22.00
Transparent Silicone	WMTS	£19.00
Wet Room Screed	WM226	£34.00
Wet Room Tile Adhesive	WMSTF20	£42.00
Purestep (1m x 5m)	WMPS05	£133.00
Purestep (1m x 10m)	WMPS10	£191.00
Purestep (1m x 20m)	WMPS20	£309.00

## INSTALLATION / MAINTENANCE KITS

Product	Order Ref	RRP Ex Vat £
Installation Ktt	WMIKU	£104.00
Maintenance Kit	WMMK	£177.00

## ACCESSORIES

Product	Order Ref	RRP Ex Vat £
Foot Rest	WMFR0001	£94.00
Soap Shelf (Linear)	WM1850.0302	£168.00
Soap Shelf (Corner)	WM2850.0201	£168.00
Strainer (Linear)	WM1810.0010	£25.00
Strainer (Corner)	WM2811.0010	£25.00
Hook	WM1840.0000	£13.00

**wm**  
wetroom materials

Wetroom Materials UK  
Derwentside  
25 Town Street  
Duffield  
Belper  
Derbyshire  
DE56 4EH  
England  
+ 44 (0) 1332 840 820

Wetroom Materials Ireland  
Unit E1  
Ballymount Ind Est  
Walkinstown  
Dublin  
Co. Dublin  
D12 WR60  
Ireland  
+353 (0)1 2973488

sales@wetroommaterials.com  
www.wetroommaterials.com

PRICE LIST



[www.wetroommaterials.com/pricelist](http://www.wetroommaterials.com/pricelist)