



# THE SHARP COLLECTION

SCANDINAVIAN WETROOM SOLUTIONS

## EURO PRICE LIST

Terms and Conditions Apply



# WM | WETROOM MATERIALS

## OVERVIEW OF TERMS AND CONDITIONS

For Full and Up To Date Terms and Conditions visit  
<https://wetroommaterials.com/retailer-and-customer-terms-conditions/>

### Minimum Order Value

Extra delivery costs may apply when ordering tanking membrane, screed or tile adhesive.

### Cancellations

We must be notified of all cancellations or returns by Email to  
[sales@wetroommaterials.com](mailto:sales@wetroommaterials.com)

Most orders are processed and dispatched the same day therefore any orders that have been dispatched cannot be cancelled and must be returned once received. See return terms and conditions.

Deliveries cannot be refused once they have been dispatched by WM. WM will need to recover all delivery costs associated with the cancelled order.

Bespoke items are non-cancellable once manufacturing has commenced.

### Returns

All Returns must be notified within 14 days of date of Delivery by Email to  
[sales@wetroommaterials.com](mailto:sales@wetroommaterials.com)

Please request & complete a Return to Stock form . A copy of which must accompany the goods.

All goods must be returned to us in the original packaging and in the original condition.

All goods returned to us are at the customer's cost.

All goods must be returned by recorded or insured delivery service.

A Restocking fee of 25% of the invoiced amount may be levied on Returns.

Bespoke items are not returnable.

### Damaged Product / Shortages

Claims for damaged goods or shortages must be made in writing to  
[sales@wetroommaterials.com](mailto:sales@wetroommaterials.com) within 24 hours of receipt; failure will result in claims being rejected.

### Title To Goods

All goods remain the property of WM | Wetroom Materials until all outstanding invoices are paid for in full, irrelevant of the date, place, or method of delivery.

## USEFUL CONTACTS

### All Orders

[orders@wetroommaterials.com](mailto:orders@wetroommaterials.com)

### Delivery Queries

[sales@wetroommaterials.com](mailto:sales@wetroommaterials.com)

### Design / Technical Specification Assistance

[sales@wetroommaterials.com](mailto:sales@wetroommaterials.com)

### All Queries

[sales@wetroommaterials.com](mailto:sales@wetroommaterials.com)

### Telephone Number

01 297 3488



The Copenhagen profile takes its inspiration from the traditional spa seat. With an ergonomic shape, the curves are designed to provide maximum comfort. Copenhagen is a modular system which allows you to create a bespoke layout with a service void. Bespoke custom made heated seats can be provided.

## MAIN SEAT - 1.2m COPENHAGEN

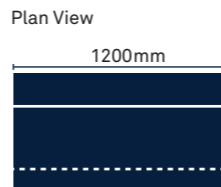
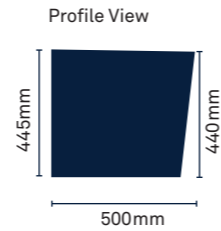

**SBCU12**  
Uncoated Sides

**SBCC12**  
Coated Sides - Required for Tiling

## MODULAR / BESPOKE PROFILES



**SBCRC**



**SBCLH/SBCRH**

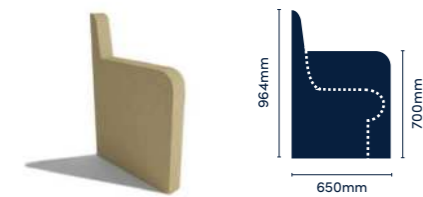

**SBCRA**



**SBCM (2 Part Set)**

Product Code	Description	RRP ex VAT €
SBCU12	Complete Seat Section 1.2m Long - Uncoated Sides	€959.00
SBCC12	Complete Seat Section 1.2m Long - Coated Sides	€1,206.00
SBCRC	Radius Corner	€1,945.00
SBCLH	Return End Large (Left Side)	€1,394.00
SBCRH	Return End Large (Right Side)	€1,394.00
SBCM	Mitred Section 1.2m x 1.2m (2 Part Set)	€2,346.00
SBCRA	Rounded Armrest	€566.00

DELIVERY NOT INCLUDED IN PRICE PLEASE CONTACT US



S-Bench  
Installation Kit  
Order Ref  
**WMSB.IK**  
RRP ex VAT  
**€165.00**

The Oslo profile is perfect for the contemporary design led shower or spa. With its clean lines, Oslo is suitable for any shape or size of tile. With no vertical back rest, which is ideal for large format tiles and stone. Oslo is a modular system which allows you to create a bespoke layout with a service void. Bespoke custom made heated seats can be provided.

## MAIN SEAT - 1.2m OSLO

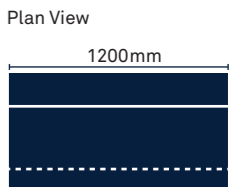
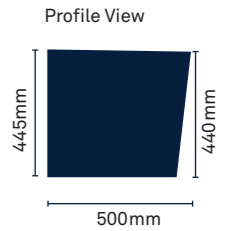
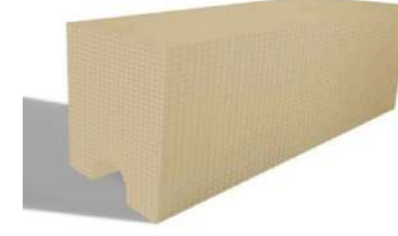

**SBOU12**  
Uncoated Sides

**SBOC12**  
Coated Sides - Required for Tiling

## MODULAR / BESPOKE PROFILES

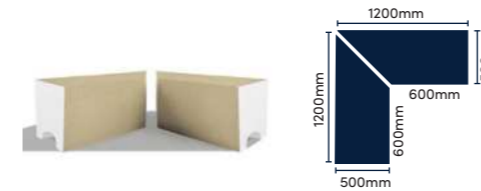

**SBOM (2 Part Set)**

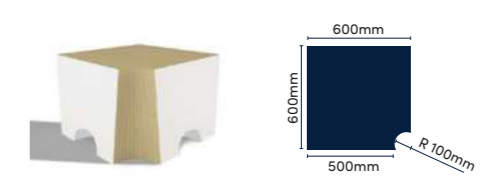

**SBORC**



**SBOLH/SBORH**

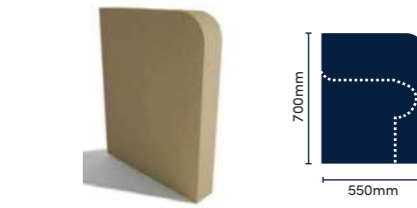

**SBORA**

Product Code	Description	RRP ex VAT €
SBOU12	Complete Seat Section 1.2m Long - Uncoated Sides	€704.00
SBOC12	Complete Seat Section 1.2m Long - Coated Sides	€952.00
SBORC	Radius Corner	€880.00
SBOLH	Return End Large (Left Side)	€880.00
SBORH	Return End Large (Right Side)	€880.00
SBOM	Mitred Section 1.2m x 1.2m (2 Part Set)	€1,887.00
SBORA	Rounded Armrest	€442.00

DELIVERY NOT INCLUDED IN PRICE PLEASE CONTACT US



S-Bench  
Installation Kit  
Order Ref  
**WMSB.IK**  
RRP ex VAT  
**€165.00**



The Stockholm profile is the perfect shower or spa seat. With an ergonomic shape base that sits neatly against a wall. This seat has no vertical back rest, which opens up a world of possibilities for wall finishes. Stockholm is a modular system which allows you to create a bespoke layout with a service void. Bespoke custom made heated seats can be provided.



**SBSU12**  
Uncoated Sides

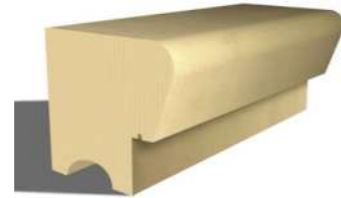

**SBSC12**  
Coated Sides - Required for Tiling

**MODULAR / BESPOKE PROFILES**

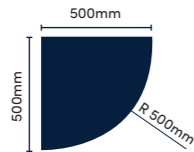

**SBSL/SBSR**

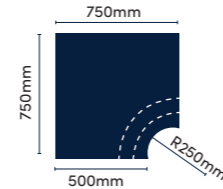

**SBSRC**

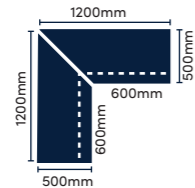

**SBSM (2 Part Set)**



**SBSRA**

Product Code	Description	RRP ex VAT €
SBSU12	Complete Seat Section 1.2m Long - Uncoated Sides	€804.00
SBSC12	Complete Seat Section 1.2m Long - Coated Sides	€1,052.00
SBSRC	Radius Corner	€1,159.00
SBSLH	Return End Large (Left Side)	€1,159.00
SBSRH	Return End Large (Right Side)	€1,159.00
SBSM	Mitred Section 1.2m x 1.2m (2 Part Set)	€2,064.00
SBSRA	Rounded Armrest	€447.00

**DELIVERY NOT INCLUDED IN PRICE PLEASE CONTACT US**



S-Bench  
Installation Kit  
Order Ref  
**WMSB.IK**  
RRP ex VAT  
**€165.00**

Wall Niches

High density Polystyrene with reinforced Cement coating and sealed gasket. Ready for tiling recesses for bathrooms and showers. Ideal for light installation.

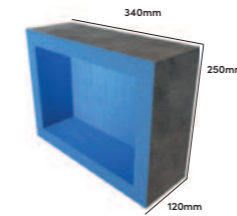

**N0250**

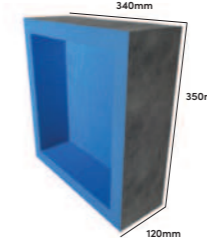

**N0350**

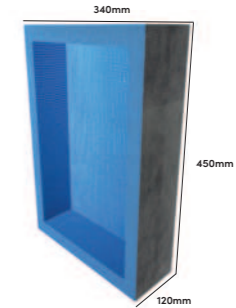

**N0450**

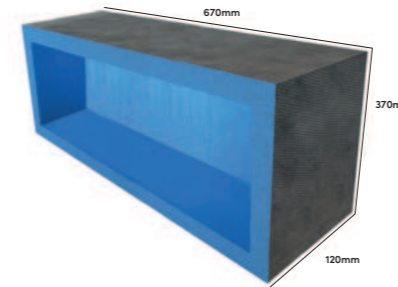

**N0670**  
Made to fit a 600mm x 300mm tile

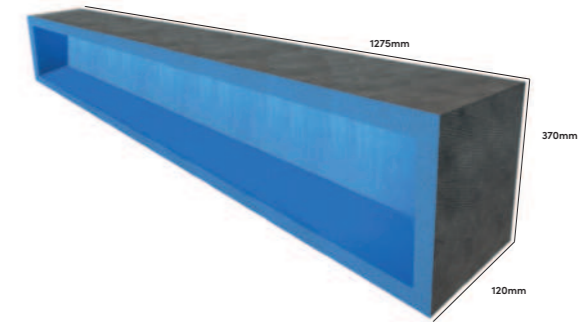

**N1275**  
Made to fit two 600mm x 300mm tiles

Product Code	External Dimensions	Internal Dimensions	RRP ex VAT €
N0250	250 x 340 x 120mm	190 x 280 x 110mm	€97.00
N0350	350 x 340 x 120mm	290 x 280 x 110mm	€103.00
N0450	450 x 340 x 120mm	390 x 280 x 110mm	€110.00
N0670	670 x 370 x 120mm	610 x 310 x 110mm	€220.00
N1275	1275 x 370 x 120mm	1215 x 310 x 110mm	€227.00



# SharpSlope® | Linear Tile Insert

## Kit Includes

- 36 Litres Per Minute Preformed Wetroom Tray
- Integrated Drain - 1½" Connection
- Sealed Gasket
- 50mm Water Seal
- Tile Insert and Frame
- Construction Glue
- 3m² Waterproofing Kit

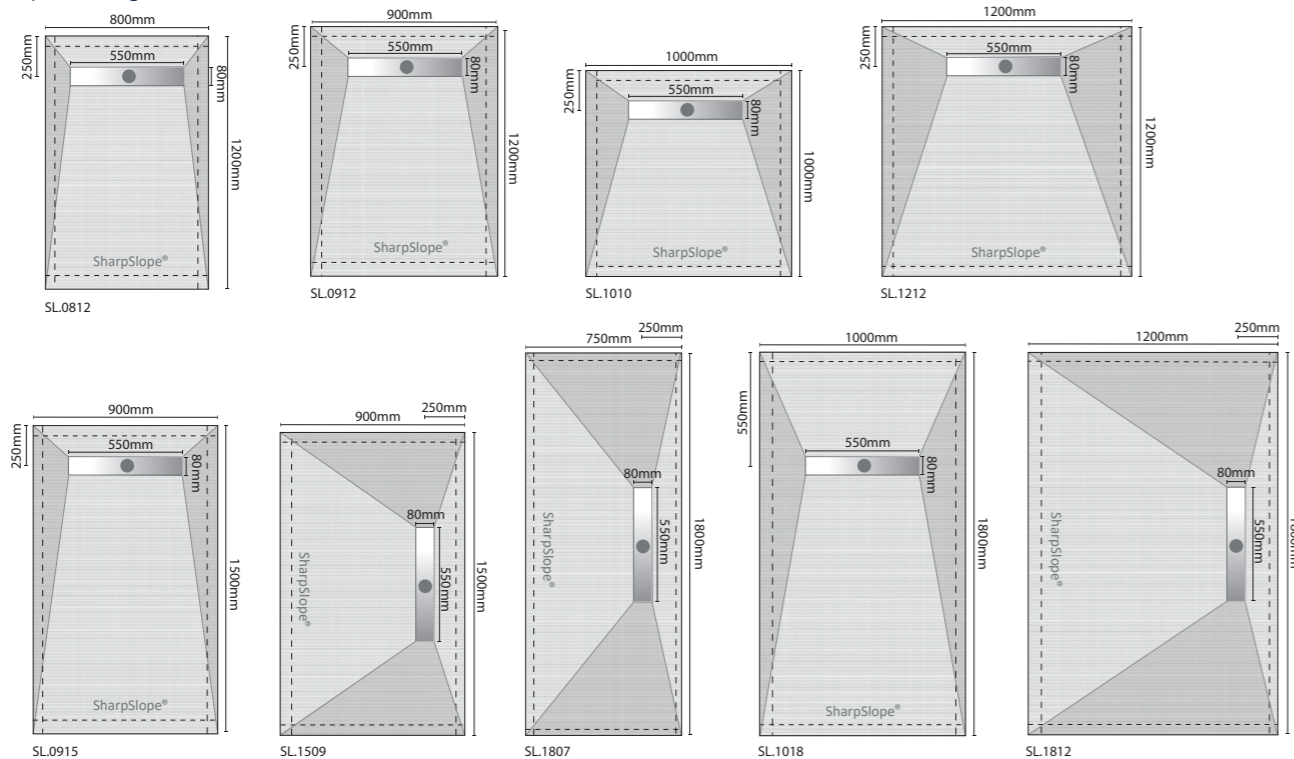
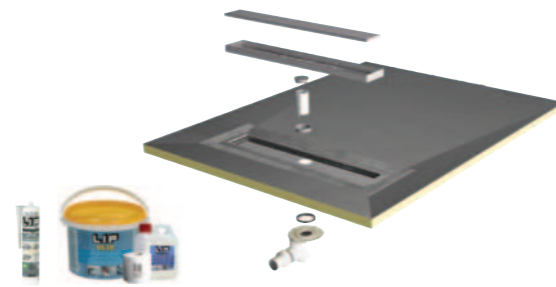

Size A B	Board Thickness	Steel Tile Insert Kit Order Ref	RRP EX VAT €	Black Tile Insert Kit Order Ref	RRP EX VAT €	Brass Tile Insert Kit Order Ref	RRP EX VAT €	Nickel Tile Insert Kit Order Ref	RRP EX VAT €	Bronze Tile Insert Kit Order Ref	RRP EX VAT €
800 x 1200	30	SL.0812SS	€776.00	SL.0812BL	€1,330.00	SL.0812BS	€1,293.00	SL.0812NI	€1,293.00	SL.0812BZ	€1,293.00
900 x 1200	30	SL.0912SS	€851.00	SL.0912BL	€1,475.00	SL.0912BS	€1,436.00	SL.0912NI	€1,436.00	SL.0912BZ	€1,436.00
900 x 1500	30	SL.0915SS	€909.00	SL.0915BL	€1,545.00	SL.0915BS	€1,506.00	SL.0915NI	€1,506.00	SL.0915BZ	€1,506.00
1000 x 1000	30	SL.1010SS	€839.00	SL.1010BL	€1,459.00	SL.1010BS	€1,420.00	SL.1010NI	€1,420.00	SL.1010BZ	€1,420.00
1000 x 1800	30	SL.1018SS	€1,048.00	SL.1018BL	€1,713.00	SL.1018BS	€1,674.00	SL.1018NI	€1,674.00	SL.1018BZ	€1,674.00
1200 x 1200	30	SL.1212SS	€939.00	SL.1212BL	€1,581.00	SL.1212BS	€1,542.00	SL.1212NI	€1,542.00	SL.1212BZ	€1,542.00
1500 x 900	30	SL.1509SS	€909.00	SL.1509BL	€1,545.00	SL.1509BS	€1,506.00	SL.1509NI	€1,506.00	SL.1509BZ	€1,506.00
1800 x 750	30	SL.1807SS	€949.00	SL.1807BL	€1,594.00	SL.1807BS	€1,556.00	SL.1807NI	€1,556.00	SL.1807BZ	€1,556.00
1800 x 1200	30	SL.1812SS	€1,157.00	SL.1812BL	€1,842.00	SL.1812BS	€1,803.00	SL.1812NI	€1,803.00	SL.1812BZ	€1,803.00



Drain Fitting Aid  
Order Ref  
**WMDFA**  
RRP exVAT  
**€64.00**



Wooden Floor Installation Kit  
Order Ref  
**WMSS.IKW**  
RRP exVAT  
**€219.00**



Concrete Floor Installation Kit  
Order Ref  
**WMSS.IKC**  
RRP exVAT  
**€146.00**



Vertical Outlet  
Order Ref  
**WMSLVO**  
RRP exVAT  
**€71.00**



Cleaning Hook  
Order Ref  
**WM1840.0000**  
RRP exVAT  
**€21.00**



Drain Fitting Aid  
Order Ref  
**WMDFA**  
RRP exVAT  
**€64.00**



Wooden Floor Installation Kit  
Order Ref  
**WMSS.IKW**  
RRP exVAT  
**€219.00**



Concrete Floor Installation Kit  
Order Ref  
**WMSS.IKC**  
RRP exVAT  
**€146.00**



Vertical Outlet  
Order Ref  
**WMSLVO**  
RRP exVAT  
**€71.00**



Cleaning Hook  
Order Ref  
**WM1840.0000**  
RRP exVAT  
**€21.00**

# SharpSlope® | Linear Panel

## Kit Includes

- 36 Litres Per Minute Preformed Wetroom Tray
- Integrated Drain - 1½" Connection
- Sealed Gasket
- 50mm Water Seal
- Tile Insert and Frame
- Construction Glue
- 3m² Waterproofing Kit

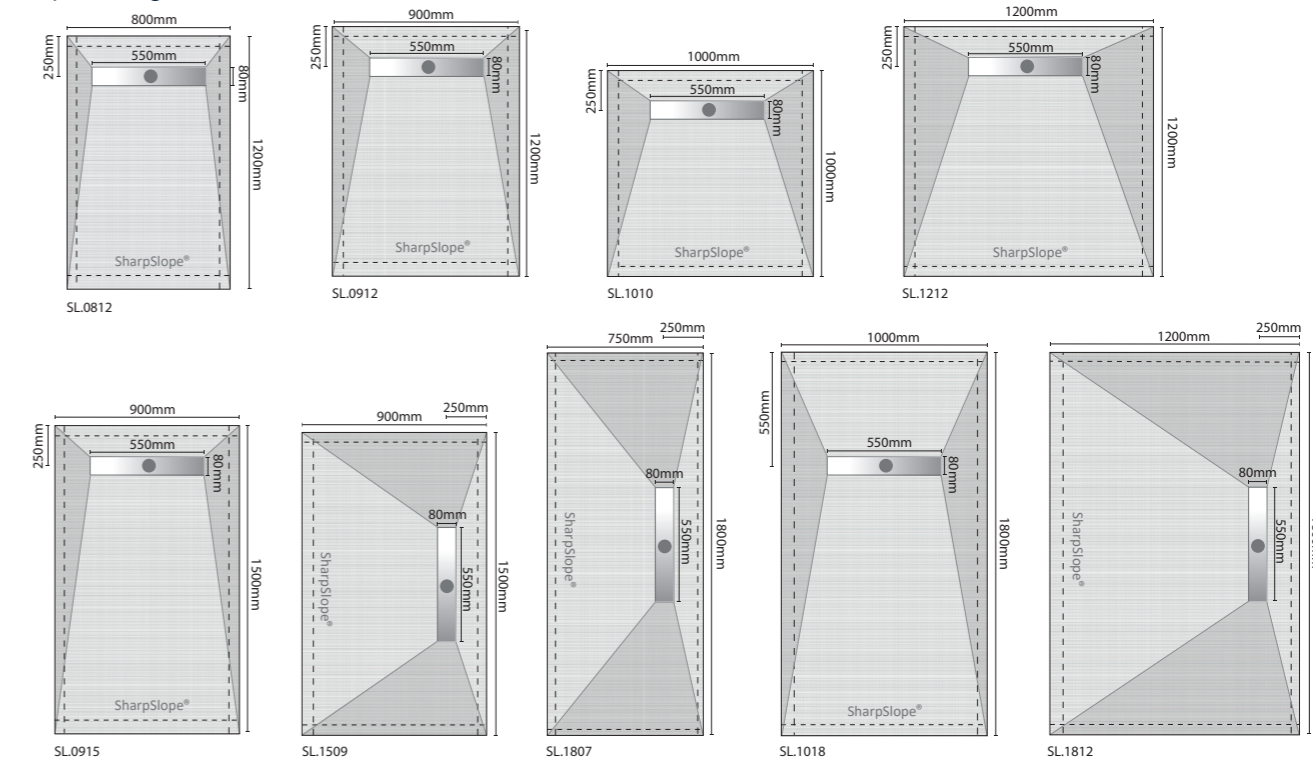

Size A B	Board Thickness	Steel Tile Insert Kit Order Ref	RRP EX VAT €	Black Tile Insert Kit Order Ref	RRP EX VAT €	Brass Tile Insert Kit Order Ref	RRP EX VAT €	Nickel Tile Insert Kit Order Ref	RRP EX VAT €	Bronze Tile Insert Kit Order Ref	RRP EX VAT €
800 x 1200	30	SL.0812SS	€776.00	SL.0812BL	€1,330.00	SL.0812BS	€1,293.00	SL.0812NI	€1,293.00	SL.0812BZ	€1,293.00
900 x 1200	30	SL.0912SS	€851.00	SL.0912BL	€1,475.00	SL.0912BS	€1,436.00	SL.0912NI	€1,436.00	SL.0912BZ	€1,436.00
900 x 1500	30	SL.0915SS	€909.00	SL.0915BL	€1,545.00	SL.0915BS	€1,506.00	SL.0915NI	€1,506.00	SL.0915BZ	€1,506.00
1000 x 1000	30	SL.1010SS	€839.00	SL.1010BL	€1,459.00	SL.1010BS	€1,420.00	SL.1010NI	€1,420.00	SL.1010BZ	€1,420.00
1000 x 1800	30	SL.1018SS	€1,048.00	SL.1018BL	€1,713.00	SL.1018BS	€1,674.00	SL.1018NI	€1,674.00	SL.1018BZ	€1,674.00
1200 x 1200	30	SL.1212SS	€939.00	SL.1212BL	€1,581.00	SL.1212BS	€1,542.00	SL.1212NI	€1,542.00	SL.1212BZ	€1,542.00
1500 x 900	30	SL.1509SS	€909.00	SL.1509BL	€1,545.00	SL.1509BS	€1,506.00	SL.1509NI	€1,506.00	SL.1509BZ	€1,506.00
1800 x 750	30	SL.1807SS	€949.00	SL.1807BL	€1,594.00	SL.1807BS	€1,556.00	SL.1807NI	€1,556.00	SL.1807BZ	€1,556.00
1800 x 1200	30	SL.1812SS	€1,157.00	SL.1812BL	€1,842.00	SL.1812BS	€1,803.00	SL.1812NI	€1,803.00	SL.1812BZ	€1,803.00



# SharpSlope® | Linear Tile Insert (Without Waterproofing Kit)

## Kit Includes

- 36 Litres Per Minute Preformed Wetroom Tray
- Integrated Drain - 1½" Connection
- Sealed Gasket
- 50mm Water Seal
- Tile Insert and Frame

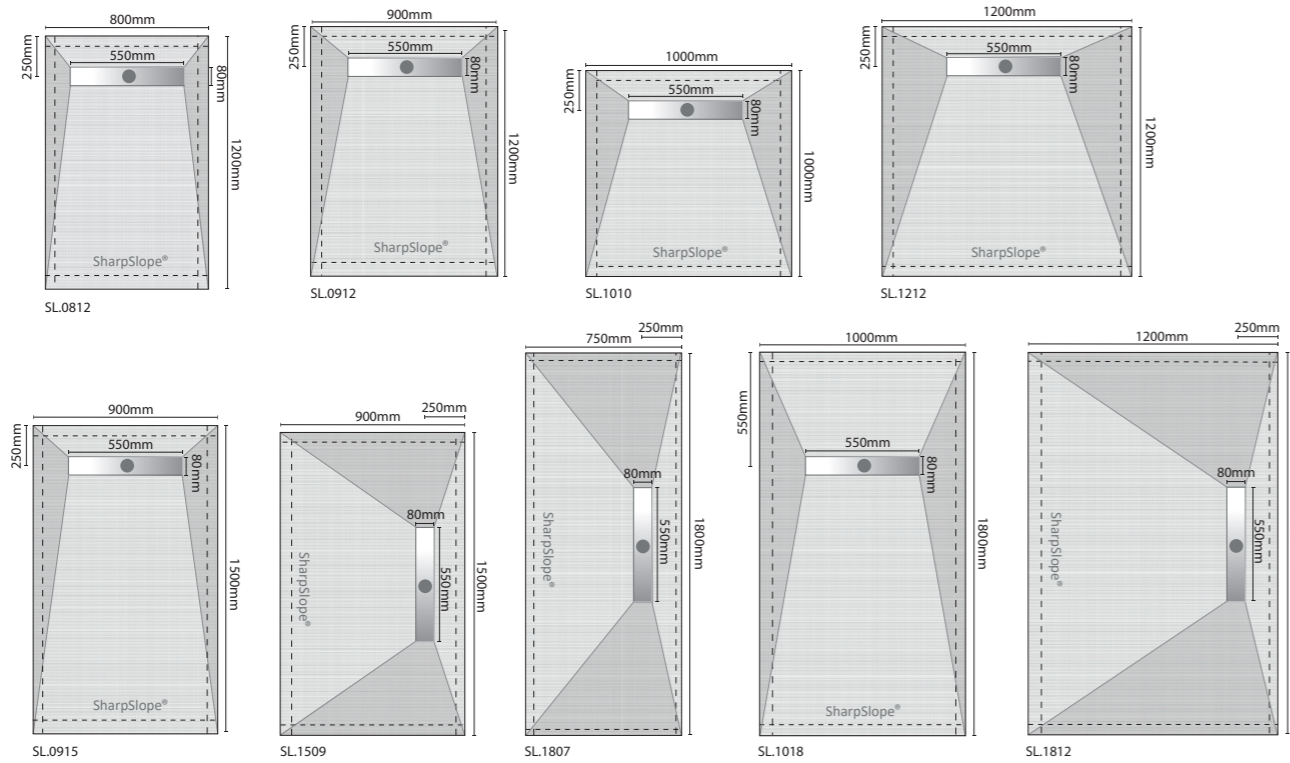
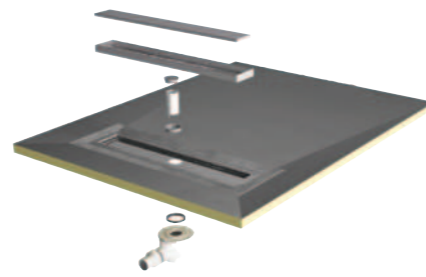

Size A B	Board Thickness	Steel Tile Insert Kit Order Ref	RRP EX VAT €	Black Tile Insert Kit Order Ref	RRP EX VAT €	Brass Tile Insert Kit Order Ref	RRP EX VAT €	Nickel Tile Insert Kit Order Ref	RRP EX VAT €	Bronze Tile Insert Kit Order Ref	RRP EX VAT €
800 x 1200	30	SL.0812SSNT	€671.00	SL.0812BLNT	€1,219.00	SL.0812BSNT	€1,185.00	SL.0812NINT	€1,185.00	SL.0812BZNT	€1,185.00
900 x 1200	30	SL.0912SSNT	€742.00	SL.0912BLNT	€1,366.00	SL.0912BSNT	€1,327.00	SL.0912NINT	€1,327.00	SL.0912BZNT	€1,327.00
900 x 1500	30	SL.0915SSNT	€800.00	SL.0915BLNT	€1,436.00	SL.0915BSNT	€1,397.00	SL.0915NINT	€1,397.00	SL.0915BZNT	€1,397.00
1000 x 1000	30	SL.1010SSNT	€730.00	SL.1010BLNT	€1,350.00	SL.1010BSNT	€1,311.00	SL.1010NINT	€1,311.00	SL.1010BZNT	€1,311.00
1000 x 1800	30	SL.1018SSNT	€939.00	SL.1018BLNT	€1,604.00	SL.1018BSNT	€1,565.00	SL.1018NINT	€1,565.00	SL.1018BZNT	€1,565.00
1200 x 1200	30	SL.1212SSNT	€830.00	SL.1212BLNT	€1,472.00	SL.1212BSNT	€1,433.00	SL.1212NINT	€1,433.00	SL.1212BZNT	€1,433.00
1500 x 900	30	SL.1509SSNT	€800.00	SL.1509BLNT	€1,436.00	SL.1509BSNT	€1,397.00	SL.1509NINT	€1,397.00	SL.1509BZNT	€1,397.00
1800 x 750	30	SL.1807SSNT	€840.00	SL.1807BLNT	€1,485.00	SL.1807BSNT	€1,447.00	SL.1807NINT	€1,447.00	SL.1807BZNT	€1,447.00
1800 x 1200	30	SL.1812SSNT	€1,048.00	SL.1812BLNT	€1,733.00	SL.1812BSNT	€1,694.00	SL.1812NINT	€1,694.00	SL.1812BZNT	€1,694.00



Drain Fitting Aid  
Order Ref  
**WMDFA**  
RRP exVAT  
**€64.00**



Wooden Floor  
Installation Kit  
Order Ref  
**WMSS.IKW**  
RRP exVAT  
**€219.00**



Concrete Floor  
Installation Kit  
Order Ref  
**WMSS.IKC**  
RRP exVAT  
**€146.00**



Vertical Outlet  
Order Ref  
**WMSLVO**  
RRP exVAT  
**€71.00**



Cleaning Hook  
Order Ref  
**WM1840.0000**  
RRP exVAT  
**€21.00**

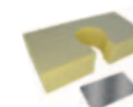

Drain Fitting Aid  
Order Ref  
**WMDFA**  
RRP exVAT  
**€64.00**



Wooden Floor  
Installation Kit  
Order Ref  
**WMSS.IKW**  
RRP exVAT  
**€219.00**



Concrete Floor  
Installation Kit  
Order Ref  
**WMSS.IKC**  
RRP exVAT  
**€146.00**



Vertical Outlet  
Order Ref  
**WMSLVO**  
RRP exVAT  
**€71.00**



Cleaning Hook  
Order Ref  
**WM1840.0000**  
RRP exVAT  
**€21.00**

# SharpSlope® | Linear Panel (Without Waterproofing Kit)

## Kit Includes

- 36 Litres Per Minute Preformed Wetroom Tray
- Integrated Drain - 1½" Connection
- Sealed Gasket
- 50mm Water Seal
- Panel and Frame

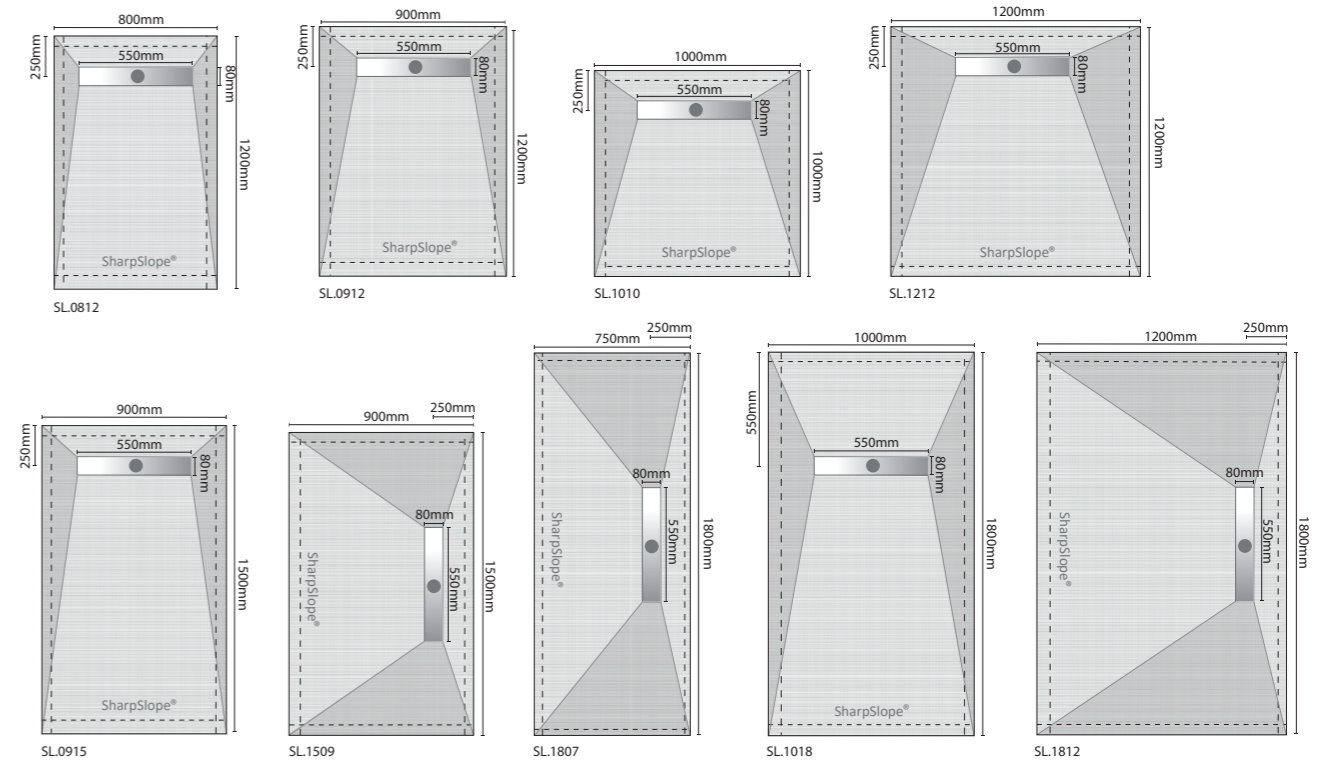
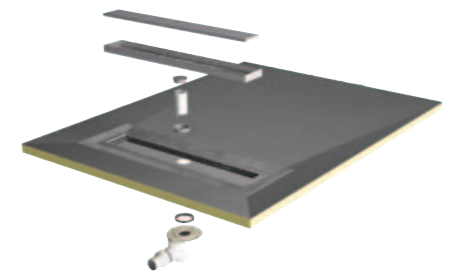

Size A B	Board Thickness	Steel Tile Insert Kit Order Ref	RRP EX VAT €	Black Tile Insert Kit Order Ref	RRP EX VAT €	Brass Tile Insert Kit Order Ref	RRP EX VAT €	Nickel Tile Insert Kit Order Ref	RRP EX VAT €	Bronze Tile Insert Kit Order Ref	RRP EX VAT €
800 x 1200	30	SL.0812SSNT	€671.00	SL.0812BLNT	€1,219.00	SL.0812BSNT	€1,185.00	SL.0812NINT	€1,185.00	SL.0812BZNT	€1,185.00
900 x 1200	30	SL.0912SSNT	€742.00	SL.0912BLNT	€1,366.00	SL.0912BSNT	€1,327.00	SL.0912NINT	€1,327.00	SL.0912BZNT	€1,327.00
900 x 1500	30	SL.0915SSNT	€800.00	SL.0915BLNT	€1,436.00	SL.0915BSNT	€1,397.00	SL.0915NINT	€1,397.00	SL.0915BZNT	€1,397.00
1000 x 1000	30	SL.1010SSNT	€730.00	SL.1010BLNT	€1,350.00	SL.1010BSNT	€1,311.00	SL.1010NINT	€1,311.00	SL.1010BZNT	€1,311.00
1000 x 1800	30	SL.1018SSNT	€939.00	SL.1018BLNT	€1,604.00	SL.1018BSNT	€1,565.00	SL.1018NINT	€1,565.00	SL.1018BZNT	€1,565.00
1200 x 1200	30	SL.1212SSNT	€830.00	SL.1212BLNT	€1,472.00	SL.1212BSNT	€1,433.00	SL.1212NINT	€1,433.00	SL.1212BZNT	€1,433.00
1500 x 900	30	SL.1509SSNT	€800.00	SL.1509BLNT	€1,436.00	SL.1509BSNT	€1,397.00	SL.1509NINT	€1,397.00	SL.1509BZNT	€1,397.00
1800 x 750	30	SL.1807SSNT	€840.00	SL.1807BLNT	€1,485.00	SL.1807BSNT	€1,447.00	SL.1807NINT	€1,447.00	SL.1807BZNT	€1,447.00
1800 x 1200	30	SL.1812SSNT	€1,048.00	SL.1812BLNT	€1,733.00	SL.1812BSNT	€1,694.00	SL.1812NINT	€1,694.00	SL.1812BZNT	€1,694.00

# SharpSlope® | Square Tile Insert

## Kit Includes

- 42 Litres Per Minute
- Preformed Wetroom Tray
- Integrated Drain - 1½" Connection
- Sealed Gasket
- 50mm Water Seal
- Tile Insert and Frame
- Construction Glue
- 3m² Waterproofing Kit

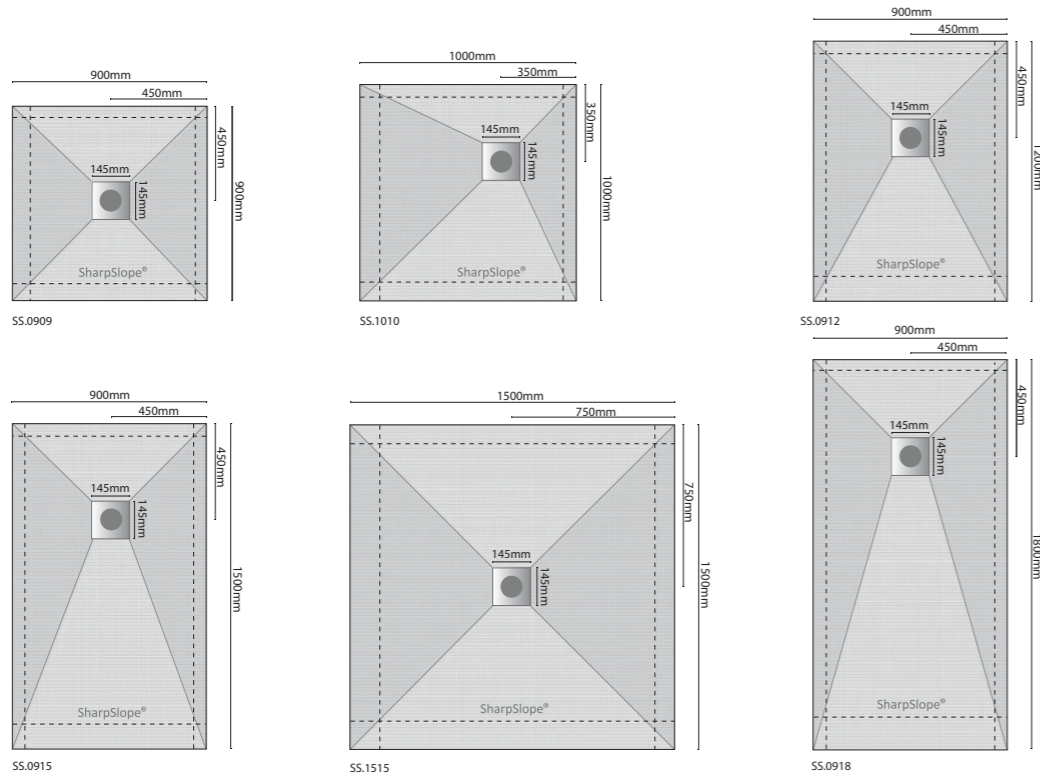

# SharpSlope® | Square Panel

## Kit Includes

- 42 Litres Per Minute
- Preformed Wetroom Tray
- Integrated Drain - 1½" Connection
- Sealed Gasket
- 50mm Water Seal
- Panel and Frame
- Construction Glue
- 3m² Waterproofing Kit

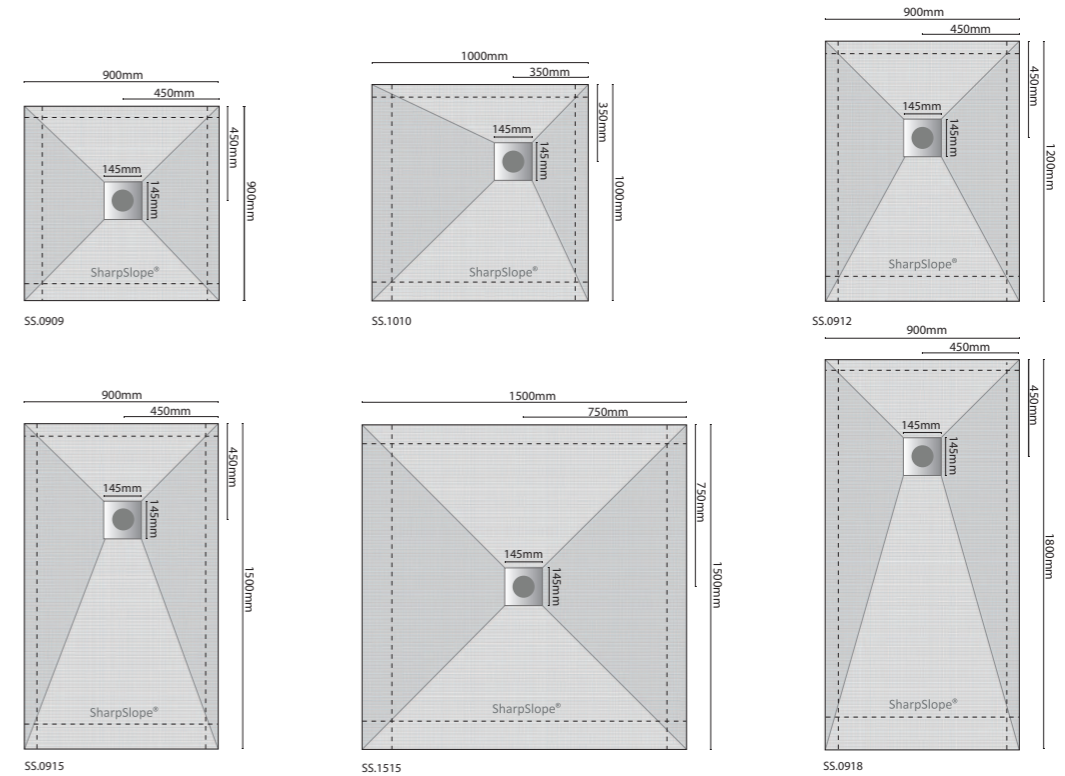

Size	Board	Steel Tile Insert	RRP EX VAT	Black Tile Insert	RRP EX VAT	Brass Tile Insert	RRP EX VAT	Nickel Tile Insert	RRP EX VAT	Bronze Tile Insert	RRP EX VAT
A B	Height	Kit Order Ref	€	Kit Order Ref	€	Kit Order Ref	€	Kit Order Ref	€	Kit Order Ref	€
900 x 900	22	SS.0909SS	€494.00	SS.0909BL	€975.00	SS.0909BS	€950.00	SS.0909NI	€950.00	SS.0909BZ	€950.00
900 x 1200	22	SS.0912SS	€517.00	SS.0912BL	€1,002.00	SS.0912BS	€978.00	SS.0912NI	€978.00	SS.0912BZ	€978.00
900 x 1500	27	SS.0915SS	€579.00	SS.0915BL	€1,077.00	SS.0915BS	€1,050.00	SS.0915NI	€1,050.00	SS.0915BZ	€1,050.00
1000 x 1000	22	SS.1010SS	€502.00	SS.1010BL	€985.00	SS.1010BS	€961.00	SS.1010NI	€961.00	SS.1010BZ	€961.00
1500 x 1500	27	SS.1515SS	€999.00	SS.1515BL	€1,793.00	SS.1515BS	€1,769.00	SS.1515NI	€1,769.00	SS.1515BZ	€1,769.00
900 x 1800	30	SS.0918SS	€672.00	SS.0918BL	€1,188.00	SS.0918BS	€1,163.00	SS.0918NI	€1,163.00	SS.0918BZ	€1,163.00

Size	Board	Frame & Grate	RRP EX VAT	Steel Panel	RRP EX VAT	Black Panel	RRP EX VAT	Brass Panel	RRP EX VAT	Nickel Panel	RRP EX VAT	Bronze Panel	RRP EX VAT
A B	Height	Kit Order Ref	€	Kit Order Ref	€	Kit Order Ref	€	Kit Order Ref	€	Kit Order Ref	€	Kit Order Ref	€
900 x 900	22	SS.0909FG	€462.00	SS.0909SS	€494.00	SS.0909BL	€975.00	SS.0909BS	€950.00	SS.0909NI	€950.00	SS.0909BZ	€950.00
900 x 1200	22	SS.0912FG	€486.00	SS.0912SS	€517.00	SS.0912BL	€1,002.00	SS.0912BS	€978.00	SS.0912NI	€978.00	SS.0912BZ	€978.00
900 x 1500	27	SS.0915FG	€548.00	SS.0915SS	€579.00	SS.0915BL	€1,077.00	SS.0915BS	€1,050.00	SS.0915NI	€1,050.00	SS.0915BZ	€1,050.00
1000 x 1000	22	SS.1010FG	€471.00	SS.1010SS	€502.00	SS.1010BL	€985.00	SS.1010BS	€961.00	SS.1010NI	€961.00	SS.1010BZ	€961.00
1500 x 1500	27	SS.1515FG	€968.00	SS.1515SS	€999.00	SS.1515BL	€1,793.00	SS.1515BS	€1,769.00	SS.1515NI	€1,769.00	SS.1515BZ	€1,769.00
900 x 1800	30	SS.0918FG	€641.00	SS.0918SS	€672.00	SS.0918BL	€1,188.00	SS.0918BS	€1,163.00	SS.0918NI	€1,163.00	SS.0918BZ	€1,163.00





# SharpSlope® | Square Tile Insert (Without Waterproofing Kit)

## Kit Includes

- 42 Litres Per Minute
- Preformed Wetroom Tray
- Integrated Drain - 1½" Connection
- Sealed Gasket
- 50mm Water Seal
- Tile Insert and Frame

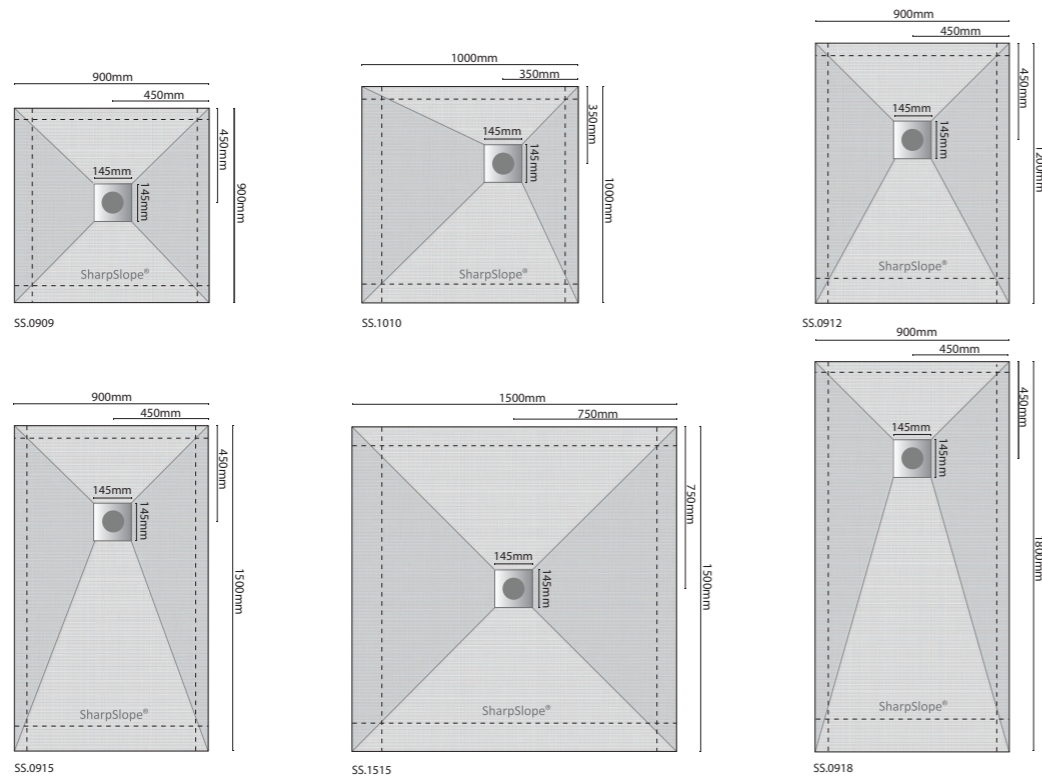

Size	Board	Steel Tile Insert	RRP EX VAT	Black Tile Insert	RRP EX VAT	Brass Tile Insert	RRP EX VAT	Nickel Tile Insert	RRP EX VAT	Bronze Tile Insert	RRP EX VAT
A B	Height	Kit Order Ref	€	Kit Order Ref	€	Kit Order Ref	€	Kit Order Ref	€	Kit Order Ref	€
900 x 900	22	SS.0909SSNT	€385.00	SS.0909BLNT	€866.00	SS.0909BSNT	€841.00	SS.0909NINT	€841.00	SS.0909BZNT	€841.00
900 x 1200	22	SS.0912SSNT	€408.00	SS.0912BLNT	€893.00	SS.0912BSNT	€869.00	SS.0912NINT	€869.00	SS.0912BZNT	€869.00
900 x 1500	27	SS.0915SSNT	€470.00	SS.0915BLNT	€968.00	SS.0915BSNT	€941.00	SS.0915NINT	€941.00	SS.0915BZNT	€941.00
1000 x 1000	22	SS.1010SSNT	€393.00	SS.1010BLNT	€876.00	SS.1010BSNT	€852.00	SS.1010NINT	€852.00	SS.1010BZNT	€852.00
1500 x 1500	27	SS.1515SSNT	€890.00	SS.1515BLNT	€1,684.00	SS.1515BSNT	€1,660.00	SS.1515NINT	€1,660.00	SS.1515BZNT	€1,660.00
900 x 1800	30	SS.0918SSNT	€563.00	SS.0918BLNT	€1,079.00	SS.0918BSNT	€1,054.00	SS.0918NINT	€1,054.00	SS.0918BZNT	€1,054.00



Drain Fitting Aid  
Order Ref  
**WMDFA**  
RRP exVAT  
**€64.00**



Wooden Floor  
Installation Kit  
Order Ref  
**WMSS.IKW**  
RRP exVAT  
**€219.00**



Concrete Floor  
Installation Kit  
Order Ref  
**WMSS.IKC**  
RRP exVAT  
**€146.00**



Vertical Outlet  
Order Ref  
**WMSSVO**  
RRP exVAT  
**€71.00**



Cleaning Hook  
Order Ref  
**WM1840.0000**  
RRP exVAT  
**€21.00**

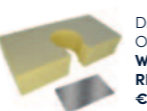

Drain Fitting Aid  
Order Ref  
**WMDFA**  
RRP exVAT  
**€64.00**



Wooden Floor  
Installation Kit  
Order Ref  
**WMSS.IKW**  
RRP exVAT  
**€219.00**



Concrete Floor  
Installation Kit  
Order Ref  
**WMSS.IKC**  
RRP exVAT  
**€146.00**



Vertical Outlet  
Order Ref  
**WMSSVO**  
RRP exVAT  
**€71.00**



Cleaning Hook  
Order Ref  
**WM1840.0000**  
RRP exVAT  
**€21.00**

# SharpSlope® | Square Panel (Without Waterproofing Kit)

## Kit Includes

- 42 Litres Per Minute
- Preformed Wetroom Tray
- Integrated Drain - 1½" Connection
- Sealed Gasket
- 50mm Water Seal
- Panel and Frame

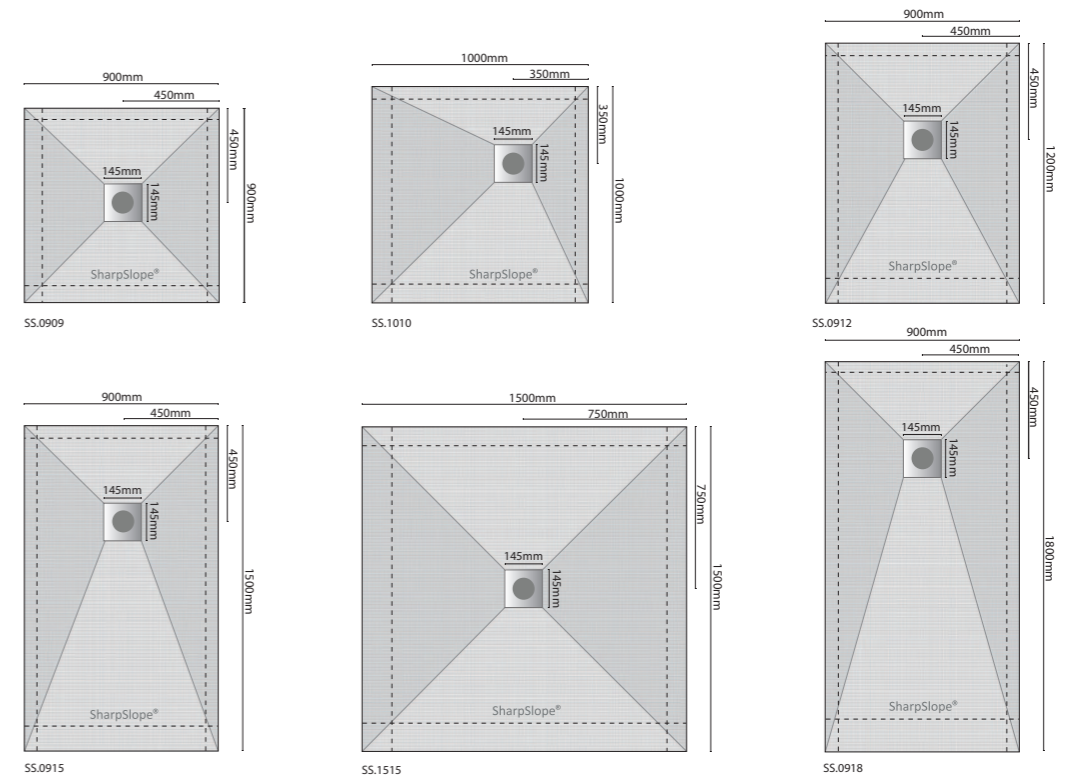

Size	Board	Frame & Grate	RRP EX VAT	Steel Panel	RRP EX VAT	Black Panel	RRP EX VAT	Brass Panel	RRP EX VAT	Nickel Panel	RRP EX VAT	Bronze Panel	RRP EX VAT
A B	Height	Kit Order Ref	€	Kit Order Ref	€	Kit Order Ref	€	Kit Order Ref	€	Kit Order Ref	€	Kit Order Ref	€
900 x 900	22	SS.0909FGNT	€353.00	SS.0909SSNT	€385.00	SS.0909BLNT	€866.00	SS.0909BSNT	€841.00	SS.0909NINT	€841.00	SS.0909BZNT	€841.00
900 x 1200	22	SS.0912FGNT	€377.00	SS.0912SSNT	€408.00	SS.0912BLNT	€893.00	SS.0912BSNT	€869.00	SS.0912NINT	€869.00	SS.0912BZNT	€869.00
900 x 1500	27	SS.0915FGNT	€439.00	SS.0915SSNT	€470.00	SS.0915BLNT	€968.00	SS.0915BSNT	€941.00	SS.0915NINT	€941.00	SS.0915BZNT	€941.00
1000 x 1000	22	SS.1010FGNT	€362.00	SS.1010SSNT	€393.00	SS.1010BLNT	€876.00	SS.1010BSNT	€852.00	SS.1010NINT	€852.00	SS.1010BZNT	€852.00
1500 x 1500	27	SS.1515FGNT	€859.00	SS.1515SSNT	€890.00	SS.1515BLNT	€1,684.00	SS.1515BSNT	€1,660.00	SS.1515NINT	€1,660.00	SS.1515BZNT	€1,660.00
900 x 1800	30	SS.0918FGNT	€532.00	SS.0918SSNT	€563.00	SS.0918BLNT	€1,079.00	SS.0918BSNT	€1,054.00	SS.0918NINT	€1,054.00	SS.0918BZNT	€1,054.00



# SharpDrain® Pro | Linear Tile Insert / Panel

## Kit Includes

- 48 Litres Per Minute Linear Drain
- 1½" Connection
- 360 rotating outlet
- 50mm Water Seal
- Tile Insert or Brushed Steel Panel and Frame
- Factory Fitted Membrane

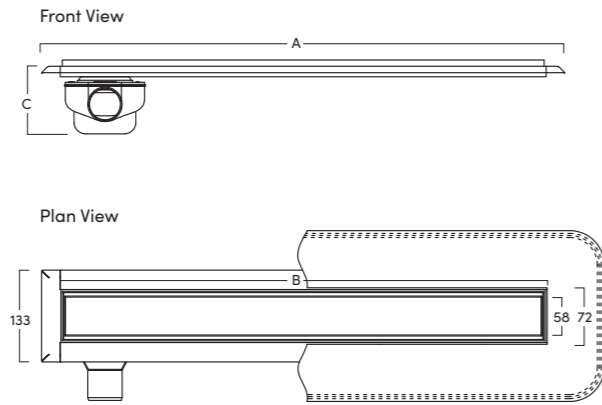

Model	Structural Length (A)	Visual Length (B)	Drain Depth (C)	Steel Tile Insert Kit Order Ref	RRP Ex VAT €	Steel Panel Kit Order Ref	RRP Ex VAT €
500	560	500	99	PSDTP:0500	€413.00	PSDTP:0500	€413.00
600	660	600	99	PSDTP:0600	€423.00	PSDTP:0600	€423.00
700	760	700	99	PSDTP:0700	€444.00	PSDTP:0700	€444.00
800	860	800	99	PSDTP:0800	€481.00	PSDTP:0800	€481.00
900	960	900	99	PSDTP:0900	€490.00	PSDTP:0900	€490.00
1000	1060	1000	99	PSDTP:1000	€512.00	PSDTP:1000	€512.00
1100	1160	1100	99	PSDTP:1100	€516.00	PSDTP:1100	€516.00
1200	1260	1200	99	PSDTP:1200	€554.00	PSDTP:1200	€554.00
1500	1560	1500	99	PSDTP:1500	€599.00	PSDTP:1500	€599.00

# SharpDrain® | Linear Tile Insert

## Kit Includes

- 32 Litres Per Minute Linear Drain
- 1½" Connection
- 50mm Water Seal
- Tile Insert
- 330mm Factory Fitted Membrane
- PVD Coated Colours

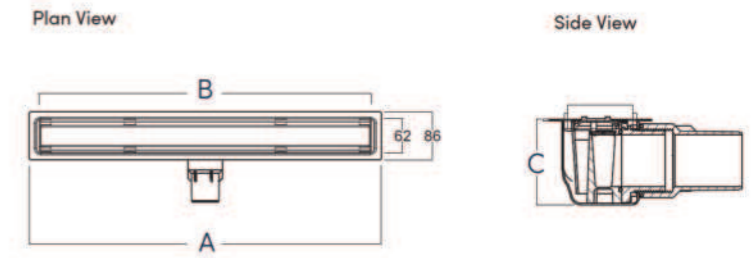

Model No.	Structural Length (A)	Visual Length (B)	Drain Depth (C)	Drain Width (D)	Steel Kit Order Ref	RRP Ex VAT €	Black Kit Order Ref	RRP Ex VAT €	Brass Kit Order Ref	RRP Ex VAT €	Nickel Kit Order Ref	RRP Ex VAT €	Bronze Kit Order Ref	RRP Ex VAT €
600	633	600	72	86	SDTP:0600	€423.00	SDTP:0600BL	€761.00	SDTP:0600BS	€720.00	SDTP:0600NI	€720.00	SDTP:0600BZ	€720.00
700	733	700	72	86	SDTP:0700	€444.00	SDTP:0700BL	€787.00	SDTP:0700BS	€745.00	SDTP:0700NI	€745.00	SDTP:0700BZ	€745.00
800	833	800	72	86	SDTP:0800	€481.00	SDTP:0800BL	€812.00	SDTP:0800BS	€770.00	SDTP:0800NI	€770.00	SDTP:0800BZ	€770.00
900	933	900	72	86	SDTP:0900	€490.00	SDTP:0900BL	€841.00	SDTP:0900BS	€801.00	SDTP:0900NI	€801.00	SDTP:0900BZ	€801.00
1000	1033	1000	72	86	SDTP:1000	€512.00	SDTP:1000BL	€866.00	SDTP:1000BS	€827.00	SDTP:1000NI	€827.00	SDTP:1000BZ	€827.00
1200	1233	1200	72	86	SDTP:1200	€554.00	SDTP:1200BL	€918.00	SDTP:1200BS	€877.00	SDTP:1200NI	€877.00	SDTP:1200BZ	€877.00

# SharpDrain® Pro | Linear Tile Line



Model	Structural Length (A)	Visual Length (B)	Drain Depth (C)	Order Ref	RRP Ex VAT €
500	560	500	104	PSDTL:0500	€403.00
600	660	600	104	PSDTL:0600	€428.00
700	760	700	104	PSDTL:0700	€440.00
800	860	800	104	PSDTL:0800	€457.00
900	960	900	104	PSDTL:0900	€478.00
1000	1060	1000	104	PSDTL:1000	€500.00
1100	1160	1100	104	PSDTL:1100	€519.00
1200	1260	1200	104	PSDTL:1200	€542.00
1500	1560	1500	104	PSDTL:1500	€595.00

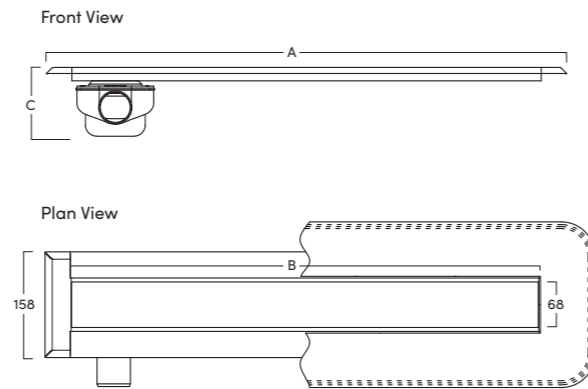

# SharpDrain® | Linear Panel

Model No.	Structural Length (A)	Visual Length (B)	Drain Depth (C)	Drain Width (D)	Steel Kit Order Ref	RRP Ex VAT €	Black Kit Order Ref	RRP Ex VAT €	Brass Kit Order Ref	RRP Ex VAT €	Nickel Kit Order Ref	RRP Ex VAT €	Bronze Kit Order Ref	RRP Ex VAT €
600	633	600	72	86	SDTP:0600	€423.00	SDTP:0600BL	€761.00	SDTP:0600BS	€720.00	SDTP:0600NI	€720.00	SDTP:0600BZ	€720.00
700	733	700	72	86	SDTP:0700	€444.00	SDTP:0700BL	€787.00	SDTP:0700BS	€745.00	SDTP:0700NI	€745.00	SDTP:0700BZ	€745.00
800	833	800	72	86	SDTP:0800	€481.00	SDTP:0800BL	€812.00	SDTP:0800BS	€770.00	SDTP:0800NI	€770.00	SDTP:0800BZ	€770.00
900	933	900	72	86	SDTP:0900	€490.00	SDTP:0900BL	€841.00	SDTP:0900BS	€801.00	SDTP:0900NI	€801.00	SDTP:0900BZ	€801.00
1000	1033	1000	72	86	SDTP:1000	€512.00	SDTP:1000BL	€866.00	SDTP:1000BS	€827.00	SDTP:1000NI	€827.00	SDTP:1000BZ	€827.00
1200	1233	1200	72	86	SDTP:1200	€554.00	SDTP:1200BL	€918.00	SDTP:1200BS	€877.00	SDTP:1200NI	€877.00	SDTP:1200BZ	€877.00



# SharpDrain® | Linear Tile Line

## Kit Includes

- 32 Litres Per Minute Linear Drain
- 1½" Connection
- 50mm Water Seal
- Tile Base
- 330mm Factory Fitted Membrane
- Polystyrene Fitting Aid



Plan View

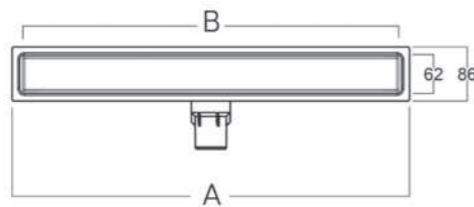

Side View

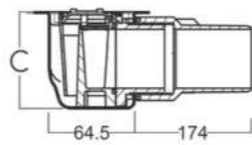

Model No.	Structural Length (A)	Visual Length (B)	Drain Depth (C)	Drain Width (D)	Kit Order Ref	RRP Ex VAT €
600	633	598	72	86	SDTL.0600	€428.00
700	733	698	72	86	SDTL.0700	€440.00
800	833	798	72	86	SDTL.0800	€457.00
900	933	898	72	86	SDTL.0900	€478.00
1000	1033	998	72	86	SDTL.1000	€500.00
1200	1233	1198	72	86	SDTL.1200	€542.00

# PourFlex® | Square

## Kit includes

- 24 Litres per minute
- 1½" Connection
- 30mm Water Seal
- PourFlex Panel



Model No.	Structural Length (A)	Visual Length (B)	Drain Depth (C)	Drain Width (D)	Kit Order Ref	RRP Ex VAT €
260	260	150	71	260	SDPF.0150	€743.00

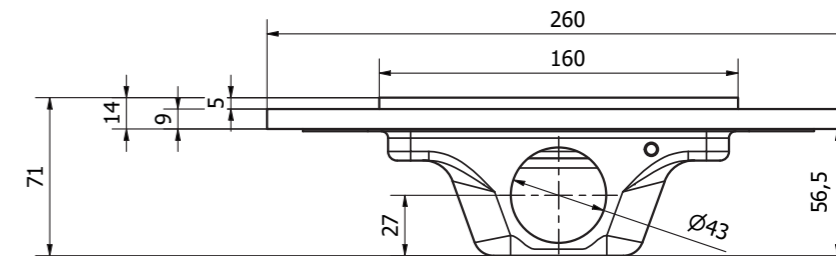

# AptLine® | Linear

## Kit Includes

- 48 Litres Per Minute
- 360° Outlet – 1½" Connection
- 50mm Water Seal
- Installation Feet
- Trimming & Tiling Guide
- Polished or Brushed
- Adjustable Panel
- 3.5m Membrane and Glue



Plan View

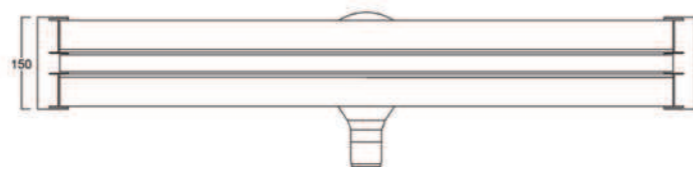

Side View

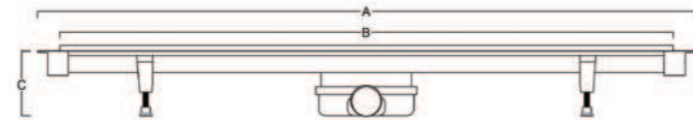

Model No.	Structural Length (A)	Visual Length (B)	Drain Depth (C)	Brushed Steel Kit Order Ref	RRP Ex VAT €	Polished Steel Kit Order Ref	RRP Ex VAT €	Tiled Kit Order Ref	RRP Ex VAT €
800	870-350	800-350	85-105	WMAL.0800SS	€398.00	WMAL.0800PS	€398.00	WMAL.0800T	€398.00
1000	1070-800	1000-800	85-105	WMAL.1000PS	€425.00	WMAL.1000SS	€425.00	WMAL.1000T	€425.00



# PourFlex® | Linear



Plan View

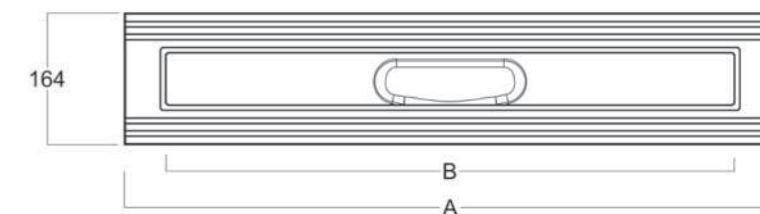

Side View

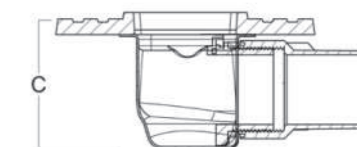

Model No.	Structural Length (A)	Visual Length (B)	Drain Depth (C)	Drain Width (D)	Kit Order Ref	RRP Ex VAT €
700	813	700	90	164	SDPF.0700	€849.00
800	913	800	90	164	SDPF.0800	€911.00
900	1013	900	90	164	SDPF.0900	€981.00





# SharpDrain® | Polished Concrete

## Kit Includes

- 36 Litres Per Minute Linear Drain
- 1½" Connection
- 360 rotating outlet
- Insert to fill with Polished Concrete or use as Brushed Stainless Steel Panel
- Installation Feet

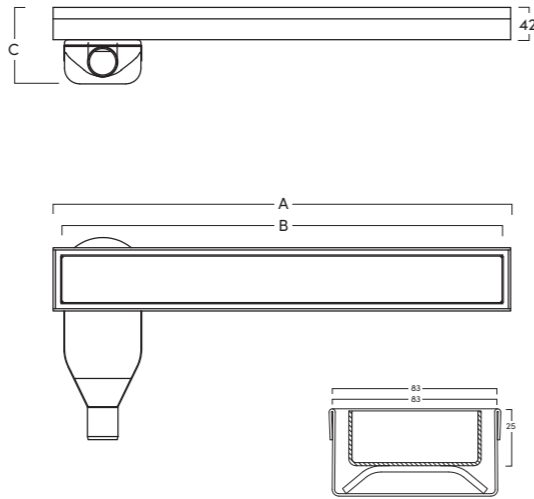

Model No.	Structural Length (A)	Visual Length (B)	Drain Depth (C)	Kit Order Ref	RRP EX VAT €
500	500	480	100	SDPC.0500	€349.00

# SharpDrain® | Square Horizontal Tile Insert

## Kit Includes

- 48 Litres Per Minute Square Drain
- 1½" Connection
- Anti Odour Barrier
- Tile Insert and Frame
- PVD Coloured Finishes

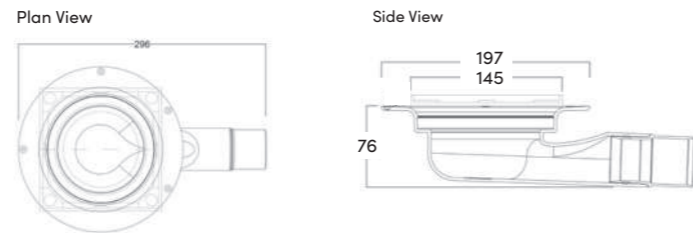

Steel Tile Insert Kit Order Ref	RRP EX VAT €	Black Tile Insert Kit Order Ref	RRP EX VAT €	Brass Tile Insert Kit Order Ref	RRP EX VAT €	Nickel Tile Insert Kit Order Ref	RRP EX VAT €	Bronze Tile Insert Kit Order Ref	RRP EX VAT €
SDSD.0076SS	€173.00	SDSD.0076BL	€438.00	SDSD.0076BS	€374.00	SDSD.0076NI	€374.00	SDSD.0076BZ	€374.00

Frame & Grate Kit Order Ref	RRP EX VAT €	Steel Panel Kit Order Ref	RRP EX VAT €	Black Panel Kit Order Ref	RRP EX VAT €	Brass Panel Kit Order Ref	RRP EX VAT €	Nickel Panel Kit Order Ref	RRP EX VAT €	Bronze Panel Kit Order Ref	RRP EX VAT €
SDSD.0076FG	€109.00	SDSD.0076SS	€173.00	SDSD.0076BL	€438.00	SDSD.0076BS	€374.00	SDSD.0076NI	€374.00	SDSD.0076BZ	€374.00

- Wooden Floor Mounting Set  
Order Ref: **WMSD.MS**  
RRP exVAT: **€75.00**
- Cleaning Hook  
Order Ref: **WM1840.0000**  
RRP exVAT: **€21.00**

# SharpDrain® | Square Vertical Tile Insert

## Kit Includes

- 48 Litres Per Minute Square Drain
- 1½" Connection
- Anti Odour Barrier
- Tile Insert and Frame
- PVD Colour Finishes

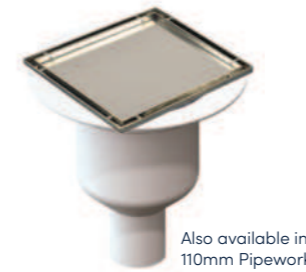

Also available in 110mm Pipework

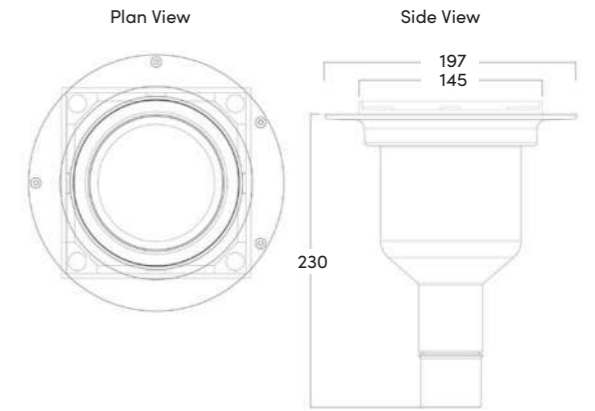

Steel Tile Insert Kit Order Ref	RRP EX VAT €	Black Tile Insert Kit Order Ref	RRP EX VAT €	Brass Tile Insert Kit Order Ref	RRP EX VAT €	Nickel Tile Insert Kit Order Ref	RRP EX VAT €	Bronze Tile Insert Kit Order Ref	RRP EX VAT €
SDSD.0189SS	€126.00	SDSD.0189BL	€450.00	SDSD.0189BS	€386.00	SDSD.0189NI	€386.00	SDSD.0189BZ	€386.00

Frame & Grate Kit Order Ref	RRP EX VAT €	Steel Panel Kit Order Ref	RRP EX VAT €	Black Panel Kit Order Ref	RRP EX VAT €	Brass Panel Kit Order Ref	RRP EX VAT €	Nickel Panel Kit Order Ref	RRP EX VAT €	Bronze Panel Kit Order Ref	RRP EX VAT €
SDSD.0189FG	€122.00	SDSD.0189SS	€126.00	SDSD.0189BL	€450.00	SDSD.0189BS	€386.00	SDSD.0189NI	€386.00	SDSD.0189BZ	€386.00

# U Channel

Length	Kit Order Ref	RRP EX VAT €
2500mm	SSUC.2500	€71.00

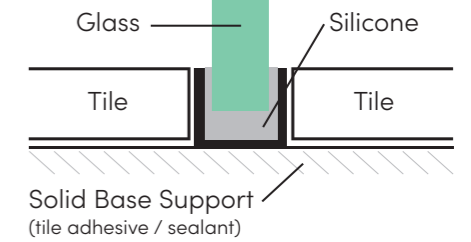
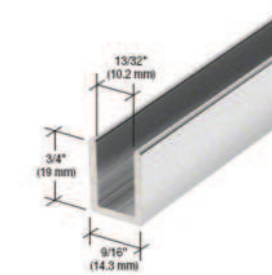

# Bracing Bar

Bracing Bar Length	Steel Kit Order Ref	RRP EX VAT €	Black Kit Order Ref	RRP EX VAT €	Brass Kit Order Ref	RRP EX VAT €	Nickel Kit Order Ref	RRP EX VAT €	Bronze Kit Order Ref	RRP EX VAT €
1000mm	SSBB.10SS	€143.00	SSBB.10BL	€252.00	SSBB.10BS	€232.00	SSBB.10NI	€232.00	SSBB.10BZ	€232.00

## Waterproofing Systems

Product Name	Description	Quantity of kits	Order Reference	RRP ex VAT Per Kit
12kg VS30 Tanking Kit 	Easy paint on application approved for wooden, cementitious, metal and plastic surfaces. Coverage up to 12m <sup>2</sup> based on 0.58mm thickness. Kit contains liquid membrane, primer and 25m reinforcement tape. <b>EC1 Plus Approved Low emissions</b>	1 - 9	WMVS30.12K	€167.00
		10 - 24	WMVS30.12K.10	€159.00
		25 +	WMVS30.12K.25	€142.00
				<b>Extra Delivery Cost May Apply</b>

Product Name	Description	Quantity of kits	Order Reference	RRP ex VAT Per Kit
3kg Tanking Kit 	Easy paint on application approved for wooden, cementitious, metal and plastic surfaces. Coverage up to 3m <sup>2</sup> based on 0.58mm thickness. Kit contains liquid membrane, primer and 25m reinforcement tape. <b>EC1 Plus Approved Low emissions</b>	1 - 9	WMVS30.03K	€81.00
		10 - 24	WMVS30.03K.10	€77.00
		25 +	WMVS30.03K.25	€73.00
				<b>Extra Delivery Cost May Apply</b>

Product Name	Description	Quantity of kits	Order Reference	RRP ex VAT Per Kit
12kg VS30 Liquid Membrane 	Easy paint on application approved for wooden, cementitious, metal and plastic surfaces. Coverage up to 12m <sup>2</sup> based on 0.58mm thickness. To be used with LIP Primer 54 and reinforcement tape.	1	WMVS30.12	€133.00
		<b>Extra Delivery Cost May Apply</b>		

Product Name	Description	Quantity of kits	Order Reference	RRP ex VAT Per Kit
3kg VS30 Liquid Membrane 	Easy paint on application approved for wooden, cementitious, metal and plastic surfaces. Coverage up to 3m <sup>2</sup> based on 0.58mm thickness. To be used with LIP Primer 54 and reinforcement tape.	1	WMVS30.03	€47.00
		<b>Extra Delivery Cost May Apply</b>		

Product Name	Description	Quantity of kits	Order Reference	RRP ex VAT Per Kit
Pipework Reinforcement Collar 	Preformed collar for waterproofing around shower pipework.	1	WMPPC	€17.00
		<b>Extra Delivery Cost May Apply</b>		

Product Name	Description	Quantity of kits	Order Reference	RRP ex VAT Per Kit
Reinforcement Tape 	Reinforcement tape to be used with LIPVS30 on all joints and around first fixes. 25 metres of tape.	1	WMT25	€17.00
		<b>Extra Delivery Cost May Apply</b>		

Product Name	Description	Quantity of kits	Order Reference	RRP ex VAT Per Kit
Construction Glue 	High performance adhesion that is water resistant. Required to fill gaps smaller than 5mm around boards and to bond tile / stone to tile insert	1	WMCG	€28.00
		<b>Extra Delivery Cost May Apply</b>		

## Waterproofing Systems

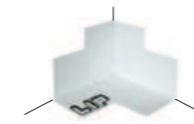

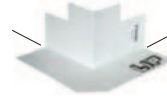
Product Name	Description	Order Reference	RRP ex VAT
Internal Corner Piece	LIP preformed reinforcement tape is used to secure the internal/external corners. This is used with LIP VS30.	WMICP	€17.00
		<b>RRP ex VAT</b>	
External Corner Piece 		WMECP	€17.00
		<b>RRP ex VAT</b>	



Product Name	Description	Order Reference	RRP ex VAT
Primer 54	Priming of substrate before applying LIP VS30. Seals pores and binds dust. 1L Bottle.	WMPR54.01	€19.00



Product Name	Description	Order Reference	RRP ex VAT
Supergrund Primer	Special primer for when extra high adhesion is required and normal primer is not suitable. 3kg Tub.	WMPRSG.03	€32.00



Product Name	Description	Order Reference	RRP ex VAT
20kg Installation Adhesive	C2TE Adhesive. Used for sheet membrane, SharpSlope Tray and PureStep and tiling Installation. EC1 Plus Approved.	WM527	€53.00
		<b>Extra Delivery Cost May Apply</b>	

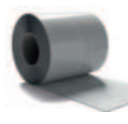

Product Name	Description	Order Reference	RRP ex VAT
10m Butyl Tape	Self adhesive waterproof tape with very strong adhesion. Can be used where RED Defence membrane meets the drain.	WMBT10	€72.00



Product Name	Description	Order Reference	RRP ex VAT
2 Component Waterproof Paste	Waterproof paste to apply sheet membrane. Use with Special Cement for faster curing. 5m <sup>2</sup> Coverage when used with Special Cement.	WMWP2K.05	€92.00
		<b>Extra Delivery Cost May Apply</b>	



Product Name	Description	Order Reference	RRP ex VAT
2 Component Special Cement	Mix with 2 Component Waterproofing Paste at 1:1 ratio for faster curing.	WMSC2K.05	€17.00
		<b>Extra Delivery Cost May Apply</b>	



Product Name	Description	Order Reference	RRP ex VAT
Wetroom Screed	20kg bag of cement based, fibre reinforced screed. Works from 2mm. Coverage 1.8kg per m <sup>2</sup> at 1mm thickness.	WM226	€42.00
		<b>Extra Delivery Cost May Apply</b>	



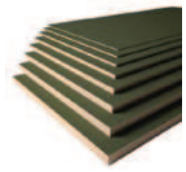

Product Name	Description	Order Reference	RRP ex VAT Per Board
SharpBoard® 6mm	Lightweight high-density construction board designed for wetrooms and bathrooms.	SB06M	€18.00
SharpBoard® 10mm		SB10M	€20.00
SharpBoard® 12.5mm	<ul style="list-style-type: none"> <li>1200 x 600mm</li> <li>Waterproof</li> <li>Insulation Properties improves heat retention</li> </ul>	SB12.5M	€23.00
SharpBoard® 20mm	<ul style="list-style-type: none"> <li>Maximises underfloor heating performance</li> </ul>	SB20M	€26.00
SharpBoard® 30mm	<ul style="list-style-type: none"> <li>Ideal for tiles, synthetic renders and decorative plaster</li> </ul>	SB30M	€32.00



Product Name	Description	Order Reference
Galvanised Washers	35mm Galvanised Washers to mechanically fix SharpBoard® to walls and floors. 100 Washers per bag.	SBGW100
		RRP ex VAT
		€25.00



Product Name	Description	Order Reference
Transparent Silicone	Highly elastic alcohol based silicone for sealing of wetroom joints.	WMTS
		RRP ex VAT
		€20.00



Product Name	Description	Order Reference	RRP ex VAT Per Board
PureStep Decoupling	Neutralises tension to reduce movement protecting floor tiles. Up to 70 dB acoustical reduction. 5, 10 and 20m roll options.	WMPS05	€121.00
		WMPS10	€187.00
		WMPS20	€321.00



Product Name	Description	Order Reference
Red Defence Sheet Membrane	Red Defence is a 3 ply waterproof sheet membrane. It has high shear resistance and is fast to install with no drying time required before tiling. It can be installed with Lip 527 installation adhesive or 2 Component waterproofing paste and cement. Available as 1m x 5m Roll.	WMRD.05
		RRP ex VAT
		€54.00



Product Name	Description	Order Reference
Reinforcement Tape	Reinforcement tape to be used with Red Defence Sheet Membrane to seal all joints and around first fixes. 10 metre rolls.	WMRD.T10
		RRP ex VAT
		€17.00



Product Name	Description	Order Reference
Corner Pieces	Preformed reinforcement pieces to be used with Red Defence Sheet Membrane.	WMRD.ICP WMRD.ECP
		RRP ex VAT
		€17.00



Product Name	Description	Order Reference
Pipework Reinforcement Collar	Preformed collar for waterproofing around shower pipework. To be used with Red Defence Sheet Membrane.	WMRD.PPL
		RRP ex VAT
		€17.00

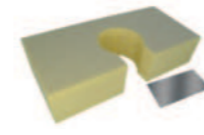

Product Name	Description	Order Reference
SharpSlope® Fitting Aid	Preformed support allowing for faster installation compared to installer creating supports. The Fitting Aid is highly recommended as it is designed for the SharpSlope® drain and provides the support required under the SharpSlope tray and around the drain to reduce movement.	WMDF A
		RRP ex VAT
		€64.00



Product Name	Description	Order Reference
SharpSlope® Wooden Floor Installation Kit	A kit designed specifically for installing SharpSlope® on a wooden floor. It includes the SharpSlope® Fitting Aid. Two 20kg bags of wetroom adhesive for installation of SharpSlope® and tiling. Two preformed internal corner pieces.	WMSS.WFIK WMSS.IKW
		RRP ex VAT
		€219.00



Product Name	Description	Order Reference
SharpSlope® Concrete Floor Installation Kit	A kit designed specifically for installing SharpSlope® on a concrete floor. It includes two 20kg bags of wetroom adhesive for installation of SharpSlope® and tiling. Two preformed internal corner pieces.	WMSS.WCIK WMSS.IKC
		RRP ex VAT
		€146.00



Product Name	Description	Order Reference
Bench Installation Kit	A kit designed specifically for installing S-Bench®. It includes one 20kg bag of wetroom adhesive to bed bench to floor, glue to fit bench to base and waterproofing membrane and tape for joints.	WMSB.IK
		RRP ex VAT
		€165.00



Product Name	Description	Order Reference
SharpDrain® Pro Linear Wooden Floor Fitting Aid	For drain model 500 – 900. It includes four wooden supports to install under the drain, four flange supports to glue or screw the drain down into position. Cut to size where required. Glue for installation, two waterproofing internal corner pieces and a pipework reinforcement collar.	WMPSD.WFIK.01
		RRP ex VAT
		€89.00



Product Name	Description	Order Reference
SharpDrain® Pro Linear Wooden Floor Fitting Aid	For drain model 1000 – 1500. It includes four wooden supports to install under the drain, four flange supports to glue or screw the drain down into position. Cut to size where required. Glue for installation and two waterproofing internal corner pieces.	WMPSD.WFIK.02
		RRP ex VAT
		€99.00



Product Name	Description	Order Reference
SharpDrain® Linear Wooden Floor Installation Set	When installing on wooden floors, you may need to cut out part of the floor around the drain. This installation set covers the hole and provides support.	WMSDL.D.WFIK
		RRP ex VAT
		€44.00

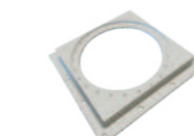

Product Name	Description	Order Reference
SharpDrain® Square Mounting Set	The mounting set makes installation on wooden floors easy. Screw the mounting set into the floor and screw the drain into the mounting set.	WMSD.MS
		RRP ex VAT
		€75.00



Product Name	Description	Order Reference
Hook	To lift drain cover and trap to remove for cleaning and maintenance.	WM1840.0000
		<b>RRP ex VAT</b>
		€21.00
Product Name	Description	Order Reference
SharpSlope® Linear Tile Insert / Panel and Frame	Replacement Brushed Stainless Steel Tile Insert and Frame Set.	SL.0550.SS
		<b>RRP ex VAT</b>
		€115.00
Product Name	Description	Order Reference
SharpSlope® Square Frame and Grate	Replacement Stainless Steel Grate and Plastic Frame Set.	SD.0150.FG
		<b>RRP ex VAT</b>
		€27.00
Product Name	Description	Order Reference
SharpSlope® Square Tile Insert / Panel and Frame	Replacement Brushed Stainless Steel Tile Insert and Frame Set.	WSD.0150.SS
		<b>RRP ex VAT</b>
		€31.00
Product Name	Description	Order Reference
SharpSlope® Linear Trap	Replacement trap for SharpSlope Linear horizontal outlet.	WMSS.SLRT
		<b>RRP ex VAT</b>
		€44.00
Product Name	Description	Order Reference
SharpSlope® Square Trap	Replacement trap for SharpSlope square horizontal outlet.	WMSS.SSRT
		<b>RRP ex VAT</b>
		€44.00
Product Name	Description	Order Reference
SharpSlope® Linear Horizontal Outlet and trap	Replacement horizontal outlet and trap set for Linear.	WMSLHO
		<b>RRP ex VAT</b>
		€71.00
Product Name	Description	Order Reference
SharpSlope® Square Horizontal Outlet and trap	Replacement horizontal outlet and trap set for Square.	WMSSH0
		<b>RRP ex VAT</b>
		€71.00
Product Name	Description	Order Reference
SharpSlope® Linear Vertical Outlet and trap	Replacement Vertical outlet and trap set for Linear.	WMSLVO
		<b>RRP ex VAT</b>
		€71.00



Product Name	Description	Order Reference			
SharpSlope® Square Vertical Outlet and trap	Replacement Vertical outlet and trap set for Square.	WMSSVO			
		<b>RRP ex VAT</b>			
		€71.00			
Product Name	Description	Order Reference			
SharpDrain® Square trap	Replacement trap.	WMSD.SQRT			
		<b>RRP ex VAT</b>			
		€45.00			
Product Name	Description	Order Reference			
SharpDrain® Square Frame and Grate	Replacement Stainless Steel Grate and Plastic Frame Set.	SD.0150.FG			
		<b>RRP ex VAT</b>			
		€27.00			
Product Name	Description	Order Reference			
SharpDrain® Square Tile Insert / Panel and Frame	Replacement Brushed Stainless Steel Tile Insert and Frame Set.	SD.0150.SS			
		<b>RRP ex VAT</b>			
		€31.00			
Product Name	Description	Order Reference			
SharpDrain® and PourFlex Linear Trap	SharpDrain® and PourFlex Linear Trap.	WMSD.LIRT			
		<b>RRP ex VAT</b>			
		€44.00			
Product Name	Description	Order Reference			
SharpDrain® Pro Linear trap	Replacement trap.	WMPSD.LIRT			
		<b>RRP ex VAT</b>			
		€44.00			
Product Name	Order Reference Linear Tile Insert and Panel	RRP ex VAT	Order Reference Linear Tile Line	RRP ex VAT	
SharpDrain® Linear Tile Insert and Panel	600 - SDTP.0600.FINISH.SS	€94.00	600 - SDTL.0600.FINISH.SS	€88.00	
	700 - SDTP.0700.FINISH.SS	€98.00	700 - SDTL.0700.FINISH.SS	€87.00	
	800 - SDTP.0800.FINISH.SS	€107.00	800 - SDTL.0800.FINISH.SS	€96.00	
	900 - SDTP.0900.FINISH.SS	€109.00	900 - SDTL.0900.FINISH.SS	€98.00	
	1000 - SDTP.1000.FINISH.SS	€113.00	1000 - SDTL.1000.FINISH.SS	€102.00	
SharpDrain® Linear Tile Line	1200 - SDTP.1200.FINISH.SS	€123.00	1200 - SDTL.1200.FINISH.SS	€112.00	
	Product Name	Order Reference Linear Tile Insert and Panel	RRP ex VAT	Order Reference Linear Tile Line	RRP ex VAT
	SharpDrain® Pro Linear Tile Insert and Panel	500 - PSDTP.0500.FINISH.SS	€91.00	500 - PSDTL.0500.FINISH.SS	€79.00
		600 - PSDTP.0600.FINISH.SS	€94.00	600 - PSDTL.0600.FINISH.SS	€88.00
	SharpDrain® Linear Tile Line	700 - PSDTP.0700.FINISH.SS	€98.00	700 - PSDTL.0700.FINISH.SS	€87.00
800 - PSDTP.0800.FINISH.SS		€107.00	800 - PSDTL.0800.FINISH.SS	€96.00	
900 - PSDTP.0900.FINISH.SS		€109.00	900 - PSDTL.0900.FINISH.SS	€98.00	
1000 - PSDTP.1000.FINISH.SS		€113.00	1000 - PSDTL.1000.FINISH.SS	€102.00	
1100 - PSDTP.1100.FINISH.SS		€117.00	1100 - PSDTL.1100.FINISH.SS	€106.00	
1200 - PSDTP.1200.FINISH.SS	€123.00	1200 - PSDTL.1200.FINISH.SS	€112.00		
1500 - PSDTP.1500.FINISH.SS	€127.00	1500 - PSDTL.1500.FINISH.SS	€117.00		





**wm**  
wetroom materials

**WM | Wetroom Materials**

Derwentside  
25 Town Street  
Duffield  
Belper  
Derbyshire  
DE56 4EH  
England  
+44 (0) 1332 840 820

[sales@wetroommaterials.com](mailto:sales@wetroommaterials.com)  
[www.wetroommaterials.com](http://www.wetroommaterials.com)

**WM | Wetroom Materials**

Unit E1  
Ballymount Ind Est  
Walkinstown  
Dublin  
Co. Dublin  
D12 WR60  
Ireland  
+353 (0)1 297 3488

FOR UP TO DATE PRICE LIST



[www.wetroommaterials.com/pricelist-euro](http://www.wetroommaterials.com/pricelist-euro)