

SharpDrain® | Vinyl Linear

SDVL.0600

New Linear SharpDrain Vinyl with 360 rotating offset outlet for tricky joists and easy connection. The drain can be rotated to have the outlet offset on the opposite site. The Vinyl Linear has a clamping ring to secure the vinyl inside the drain.



Specification

MATERIAL

STAINLESS STEEL AND PLASTIC

GRATING

BRUSHED STAINLESS STEEL PANEL

CAPACITY

48 l/min

USAGE

LINEAR DRAIN

CLAMPING RING

YES

FLOORING

VINYL

WATER TRAP HEIGHT

50mm

REMOVABLE TRAP FOR CLEANING

YES

OUTLET

360° ROTATING OUTLET

SharpDrain® | Vinyl Linear

SDVL.0600

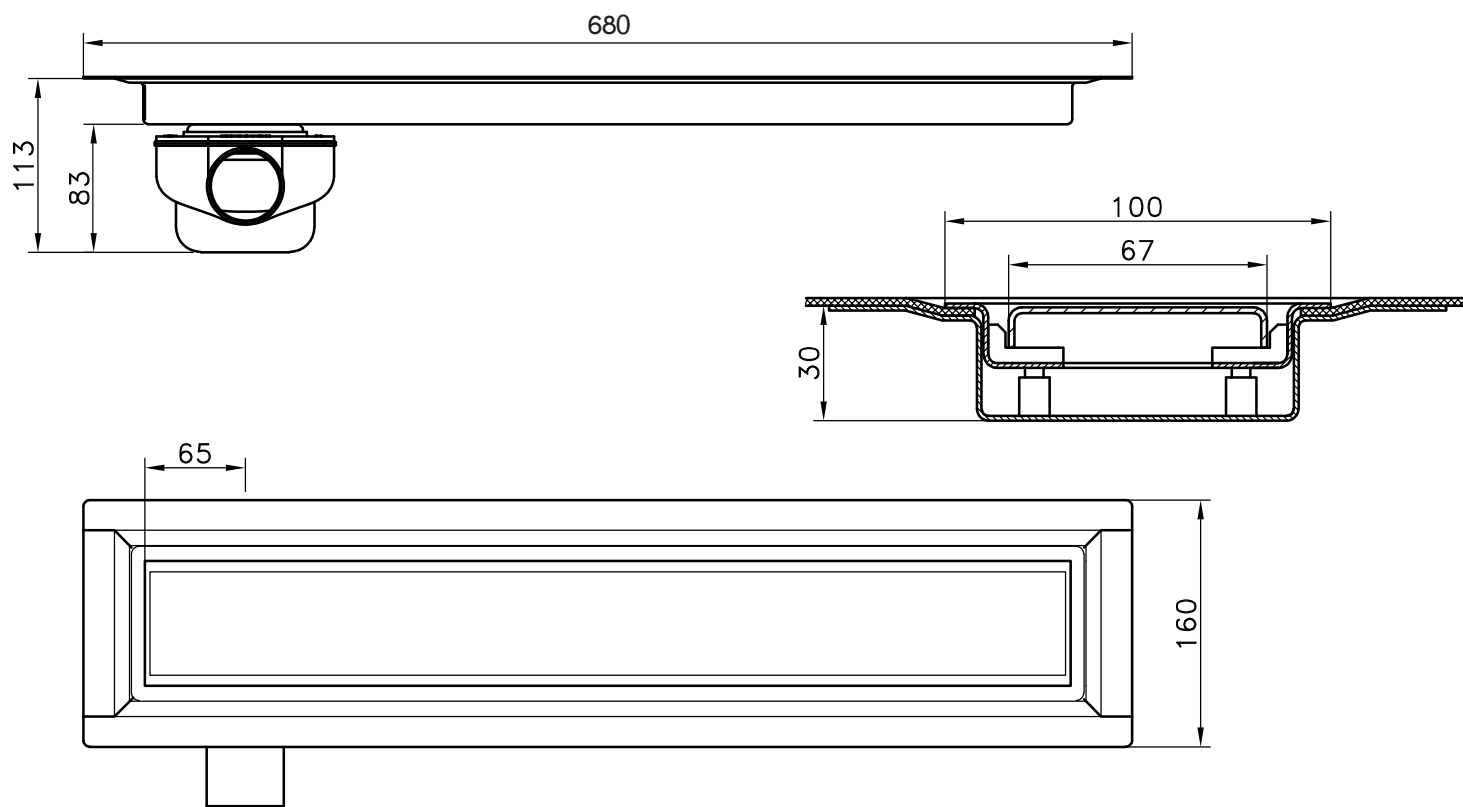

STRUCTURAL LENGTH

680mm

VISUAL LENGTH

600mm

DRAIN DEPTH

113mm

WM | Wetroom Materials

www.wetroommaterials.com sales@wetroommaterials.com

UK: Derwentside, 25 Town Street, Duffield, Belper, Derbyshire, DE56 4EH T: +44 (0) 1332 840 820
IRE: Unit E1 Ballymount Industrial Estate, Walkinstown, Dublin 12, D12 WR60 T: +353 (0) 1 297 3488