

SharpDrain® Pro | Linear Tile Line

PSDTL.0800

New and improved SharpDrain with 360 rotating offset outlet for tricky joists and easy connection. The drain can be rotated to have the outlet offset on the opposite site. Factory fitted membrane for added waterproof protection. Tile Line gives you the option to tile onto the drain with no visible metal trim for the invisible drain look.

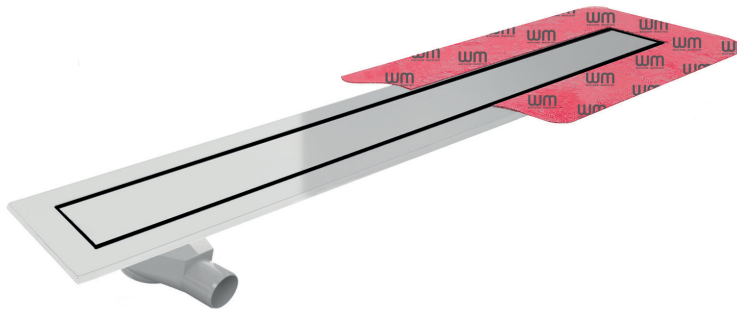

Specification

MATERIAL

Stainless Steel and Plastic

GRATING

Brushed Stainless Steel Panel to tile onto

CAPACITY

48 l/min

USAGE

LINEAR DRAIN

MEMBRANE

FACTORY FITTED SHEET MEMBRANE

FLOORING

TILES

WATER TRAP HEIGHT

50mm

REMOVABLE TRAP FOR CLEANING

YES

OUTLET

360° ROTATING OUTLET

SharpDrain® Pro Tile Line

PSDTL.0800

Front View

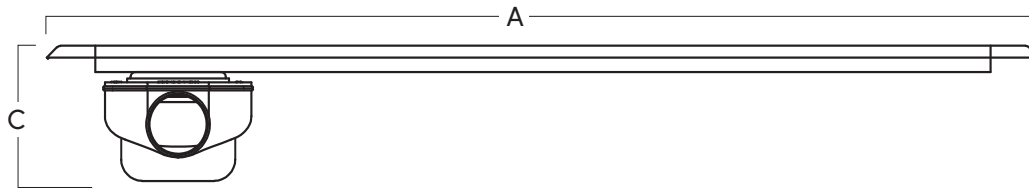

Plan View

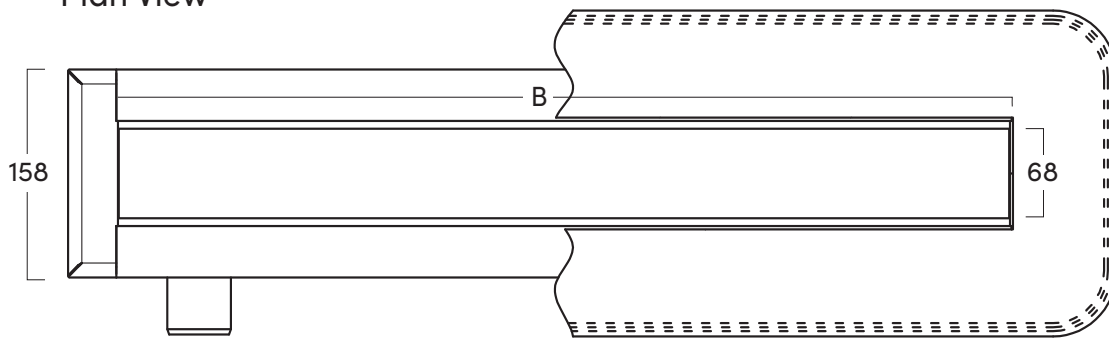

STRUCTURAL LENGTH - A

880mm

VISUAL LENGTH - B

800mm

DRAIN DEPTH - C

104mm