

# THE PLATINUM COLLECTION

SCANDINAVIAN WETROOM SOLUTIONS

## EURO PRICE LIST

Terms and Conditions Apply

Delivery Costs

Pallet for Dublin €30.00 | Outside Dublin €80.00

Parcel Costs €10.00

# WM | Wetroom Materials

## Retailer Terms & Conditions

For the most up-to-date version, visit:

[www.wetroommaterials.com/retailer-and-customer-terms-conditions/](http://www.wetroommaterials.com/retailer-and-customer-terms-conditions/)

### 1. Minimum Order Value

A minimum order value applies to all purchases. Additional delivery charges may apply for tanking membrane, screed, or tile adhesive due to weight and handling requirements. Please contact WM for specific cost details.

### 2. Payment Terms

Unless otherwise agreed in writing, all invoices are payable within 30 days from the date of invoice.

WM reserves the right to require pro forma payment or deposit payments for certain orders, including but not limited to large orders, special orders, or bespoke items.

Late payments may result in:

- Suspension of future deliveries until the account is brought up to date.
- Withdrawal of any previously agreed credit facilities.
- All payments must be made in full and without deduction, set-off, or counterclaim unless agreed by WM in writing.
- Ownership of goods does not pass to the customer until all outstanding invoices are settled in full (see Section 6: Title to Goods).

### 3. Cancellations

All cancellations must be made in writing via email to [sales@wetroommaterials.com](mailto:sales@wetroommaterials.com)

Orders can only be cancelled before dispatch. Many orders are dispatched the same day, so rapid notification is essential.

Once an order has been dispatched, it cannot be cancelled. Goods must instead be returned in accordance with the Returns Policy.

Deliveries cannot be refused once dispatched; all associated delivery and return costs will be recovered by WM.

Bespoke or made-to-order items cannot be cancelled once manufacturing has commenced.

### 4. Returns

All return requests must be made within 14 days of delivery by emailing [sales@wetroommaterials.com](mailto:sales@wetroommaterials.com)

Approved returns must arrive at our warehouse no later than 30 days from the original delivery date.

A completed Returns Form must accompany all returned goods.

Goods must be in their original packaging and in unused, resalable condition.

Refunds are not available for items that have already been assembled or installed.

Return shipping costs are the responsibility of the customer. All goods must be sent via recorded or insured delivery.

A 25% restocking fee will be applied to returned items.

Bespoke or made-to-order products are not returnable.

### 5. Damaged Goods & Shortages

Claims for damaged items, missing parts, or shortages must be submitted in writing within 24 hours of delivery to

[sales@wetroommaterials.com](mailto:sales@wetroommaterials.com)

Claims received outside this timeframe cannot be accepted.

Customers may be required to supply photographs, retain packaging, or hold goods for inspection.

### 6. Delivery

Delivery times provided by WM are estimates only and may vary.

Additional charges may apply for palletised, oversized, or heavy goods.

Risk transfers to the customer once goods are delivered to the address provided, regardless of whether the customer is present to receive the delivery.

### 7. Title to Goods

All goods remain the property of WM | Wetroom Materials until all invoices relating to the order are paid in full.

This includes:

- The right to reclaim goods if payment is not received.
- No transfer of ownership until full settlement of all outstanding balances.

### 8. Bespoke Orders

Items that are bespoke, customised, or made to order are:

- Non-cancellable once manufacturing has commenced.
- Non-returnable.
- Non-refundable.

### 9. Liability

WM shall not be liable for indirect, incidental, or consequential losses arising from the use, installation, or resale of goods.

WM's total liability is limited to the invoiced value of the goods supplied.

Retailers are responsible for ensuring that products are installed correctly and in accordance with manufacturer guidelines.

WM are not responsible for any incorrect installations that result in damaged goods or property.

### 10. Amendments to Terms

WM reserves the right to update or amend these Terms & Conditions at any time.

The most recent version published on our website will apply to all orders.



## USEFUL CONTACTS

### All Orders

[orders@wetroommaterials.com](mailto:orders@wetroommaterials.com)

### Delivery Queries

[sales@wetroommaterials.com](mailto:sales@wetroommaterials.com)

### Design / Technical Specification Assistance

[sales@wetroommaterials.com](mailto:sales@wetroommaterials.com)

### All Queries

[sales@wetroommaterials.com](mailto:sales@wetroommaterials.com)

### Telephone Number

01 297 3488

**ALL KITS INCLUDE**  
 A DRAIN – 48LTR / MIN  
 PREFORMED SLOPE BOARD  
 12m<sup>2</sup> WATERPROOFING SYSTEM

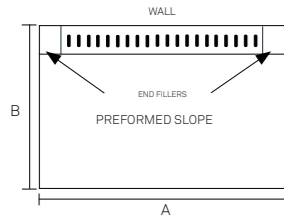
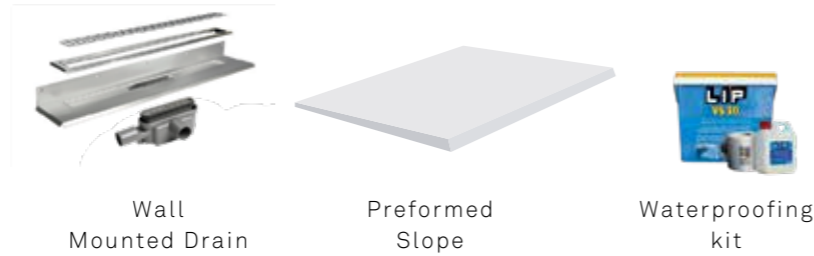

## DESIGN OPTIONS

A	B	Minimum Size	Board Height	Drain Model	Anniversario Grate 12mm Frame Kit Order Ref	RRP	Highline Custom Kit Order Ref	RRP	Highline Panel 15mm Frame Kit Order Ref	RRP	Highline Cassette 15mm Frame Kit Order Ref	RRP	
						EX VAT		EX VAT		EX VAT		EX VAT	
750	x 900	432	x 500	19	300	1K0750.09001	€1,108.00	1K0750.09002	€1,098.00	1K0750.09003	€1,410.00	1K0750.09004	€1,344.00
750	x 1200	432	x 900	23	300	1K0750.12001	€1,256.00	1K0750.12002	€1,267.00	1K0750.12003	€1,556.00	1K0750.12004	€1,490.00
750	x 1660	432	x 1200	30	300	1K0750.16601	€1,355.00	1K0750.16602	€1,366.00	1K0750.16603	€1,655.00	1K0750.16604	€1,589.00
800	x 900	712	x 500	19	600	1K0800.09001	€1,295.00	1K0800.09002	€1,348.00	N/A	N/A	N/A	N/A
800	x 1200	712	x 900	23	600	1K0800.12001	€1,494.00	1K0800.12002	€1,545.00	N/A	N/A	N/A	N/A
800	x 1660	712	x 1200	30	600	1K0800.16601	€1,611.00	1K0800.16602	€1,661.00	N/A	N/A	N/A	N/A
900	x 900	812	x 500	19	700	1K0900.09001	€1,295.00	1K0900.09002	€1,348.00	1K0900.09003	€1,696.00	1K0900.09004	€1,619.00
900	x 1200	812	x 900	23	700	1K0900.12001	€1,494.00	1K0900.12002	€1,545.00	1K0900.12003	€1,894.00	1K0900.12004	€1,817.00
900	x 1660	812	x 1200	30	700	1K0900.16601	€1,611.00	1K0900.16602	€1,661.00	1K0900.16603	€2,011.00	1K0900.16604	€1,934.00
1000	x 900	912	x 500	19	800	1K1000.09001	€1,331.00	1K1000.09002	€1,394.00	1K1000.09003	€1,735.00	1K1000.09004	€1,678.00
1000	x 1200	912	x 900	23	800	1K1000.12001	€1,348.00	1K1000.12002	€1,593.00	1K1000.12003	€1,934.00	1K1000.12004	€1,875.00
1000	x 1660	912	x 1200	30	800	1K1000.16601	€1,647.00	1K1000.16602	€1,710.00	1K1000.16603	€2,051.00	1K1000.16604	€1,991.00
1200	x 900	1012	x 500	19	900	1K1200.09001	€1,479.00	1K1200.09002	€1,548.00	1K1200.09003	€1,916.00	1K1200.09004	€1,853.00
1200	x 1200	1012	x 900	23	900	1K1200.12001	€1,771.00	1K1200.12002	€1,842.00	1K1200.12003	€2,208.00	1K1200.12004	€2,147.00
1200	x 1660	1012	x 1200	30	900	1K1200.16601	€1,971.00	1K1200.16602	€2,040.00	1K1200.16603	€2,406.00	1K1200.16604	€2,345.00
1500	x 900	1112	x 500	19	1000	1K1500.09001	€1,534.00	1K1500.09002	€1,611.00	1K1500.09003	€1,991.00	1K1500.09004	€1,934.00
1500	x 1200	1112	x 900	23	1000	1K1500.12001	€1,828.00	1K1500.12002	€1,905.00	1K1500.12003	€2,285.00	1K1500.12004	€2,228.00
1500	x 1660	1112	x 1200	30	1000	1K1500.16601	€2,026.00	1K1500.16602	€2,101.00	1K1500.16603	€2,484.00	1K1500.16604	€2,425.00
1650	x 900	1312	x 500	19	1200	1K1650.09001	€1,757.00	1K1650.09002	€1,820.00	1K1650.09003	€2,231.00	1K1650.09004	€1,856.00
1650	x 1200	1312	x 900	23	1200	1K1650.12001	€2,101.00	1K1650.12002	€2,164.00	1K1650.12003	€2,576.00	1K1650.12004	€2,200.00
1650	x 1660	1312	x 1200	30	1200	1K1650.16601	€2,318.00	1K1650.16602	€2,381.00	1K1650.16603	€2,792.00	1K1650.16604	€2,417.00



Hook  
Order Ref **WM1840.0000**  
RRP EX VAT **€21.00**

Linear Drain Strainer  
Order Ref **WM1810.0010**  
RRP EX VAT **€25.00**

Less Cleaning Trap  
Order Ref **1820.0080**  
RRP EX VAT **€80.00**

Maintenance Kit  
Order Ref **WMMK**  
RRP EX VAT **€210.00**

Installation Kit  
Order Ref **WMSSIK**  
RRP EX VAT **€146.00**

Tanking Kit  
Order Ref **WMVS30.12K**  
RRP EX VAT **€167.00**

**ALL KITS INCLUDE**  
 A DRAIN – 96LTR / MIN  
 PREFORMED SLOPE BOARD  
 12m<sup>2</sup> WATERPROOFING SYSTEM

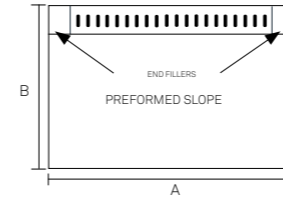
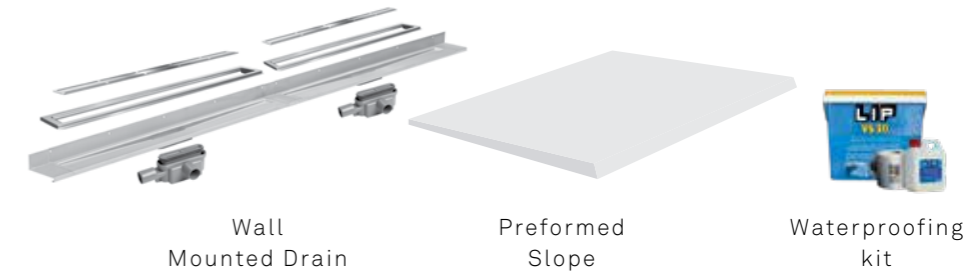

## DESIGN OPTIONS

A	B	Minimum Size	Board Height	Drain Model	Anniversario Grate 12mm Frame Kit Order Ref	RRP	Highline Custom Kit Order Ref	RRP	Highline Panel 15mm Frame Kit Order Ref	RRP	Highline Cassette 15mm Frame Kit Order Ref	RRP	
						EX VAT		EX VAT		EX VAT		EX VAT	
1800	x 900	1509	x 500	19	1400	1K1800.09001	€2,260.00	1K1800.09002	€2,363.00	1K1800.09003	€3,060.00	1K1800.09004	€2,906.00
1800	x 1200	1509	x 900	23	1400	1K1800.12001	€2,656.00	1K1800.12002	€2,758.00	1K1800.12003	€3,456.00	1K1800.12004	€3,300.00
1800	x 1660	1509	x 1200	30	1400	1K1800.16601	€2,891.00	1K1800.16602	€2,992.00	1K1800.16603	€3,690.00	1K1800.16604	€3,536.00
2000	x 900	1709	x 500	19	1600	1K2000.09001	€2,400.00	1K2000.09002	€2,524.00	1K2000.09003	€3,206.00	1K2000.09004	€3,088.00
2000	x 1200	1709	x 900	23	1600	1K2000.12001	€2,796.00	1K2000.12002	€2,920.00	1K2000.12003	€3,602.00	1K2000.12004	€3,484.00
2000	x 1660	1709	x 1200	30	1600	1K2000.16601	€3,030.00	1K2000.16602	€3,154.00	1K2000.16603	€3,836.00	1K2000.16604	€3,720.00
2250	x 900	1909	x 500	19	1800	1K2250.09001	€2,604.00	1K2250.09002	€2,744.00	1K2250.09003	€3,478.00	1K2250.09004	€3,353.00
2250	x 1200	1909	x 900	23	1800	1K2250.12001	€3,044.00	1K2250.12002	€3,184.00	1K2250.12003	€3,918.00	1K2250.12004	€3,793.00
2250	x 1660	1909	x 1200	30	1800	1K2250.16601	€3,342.00	1K2250.16602	€3,481.00	1K2250.16603	€4,213.00	1K2250.16604	€4,089.00
2500	x 900	2109	x 500	19	2000	1K2500.09001	€3,016.00	1K2500.09002	€3,169.00	1K2500.09003	€3,959.00	1K2500.09004	€3,820.00
2500	x 1200	2109	x 900	23	2000	1K2500.12001	€3,585.00	1K2500.12002	€3,752.00	1K2500.12003	€4,576.00	1K2500.12004	€4,442.00
2500	x 1660	2109	x 1200	30	2000	1K2500.16601	€3,886.00	1K2500.16602	€4,052.00	1K2500.16603	€4,880.00	1K2500.16604	€4,747.00
2750	x 900	2509	x 500	19	2400	1K2750.09001	€3,811.00	1K2750.09002	€3,943.00	1K2750.09003	€4,840.00	1K2750.09004	€4,713.00
2750	x 1200	2509	x 900	23	2400	1K2750.12001	€4,399.00	1K2750.12002	€4,533.00	1K2750.12003	€5,436.00	1K2750.12004	€5,307.00
2750	x 1660	2509	x 1200	30	2400	1K2750.16601	€4,713.00	1K2750.16602	€4,849.00	1K2750.16603	€5,754.00	1K2750.16604	€5,625.00



Hook  
Order Ref **WM1840.0000**  
RRP EX VAT **€25.00**

Linear Drain 2 x Strainers  
Order Ref **WM1810.0010.2**  
RRP EX VAT **€50.00**

Less Cleaning Trap  
Order Ref **1820.0080**  
RRP EX VAT **€80.00**

Maintenance Kit 2 x Strainers  
Order Ref **WMMK.2**  
RRP EX VAT **€235.00**

Installation Kit  
Order Ref **WMSSIK**  
RRP EX VAT **€146.00**

Tanking Kit  
Order Ref **WMVS30.12K**  
RRP EX VAT **€167.00**

**ALL KITS INCLUDE**

A DRAIN – 48LTR / MIN  
 PVD DURABLE FINISH  
 PREFORMED SLOPE BOARD  
 12m<sup>2</sup> WATERPROOFING SYSTEM

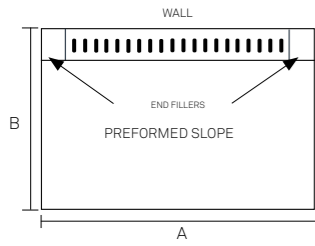
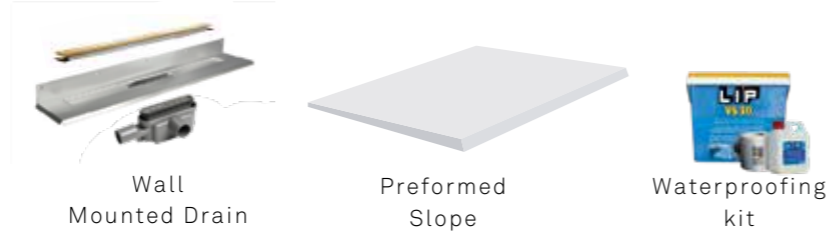

**DESIGN OPTIONS WITHOUT FRAME**



Size A	Size B	Minimum Size	Board Height	Drain Model	Highline Panel Brass Kit Order Ref	RRP EX VAT €	Highline Panel Copper Kit Order Ref	RRP EX VAT €	Highline Panel Black Kit Order Ref	RRP EX VAT €	Highline Panel Polished Stainless Kit Order Ref	RRP EX VAT €
750 x 900	432 x 500	19	300	1K0750.09005NF	€1,259.00	1K0750.09006NF	€1,259.00	1K0750.09007NF	€1,278.00	1K0750.09008NF	€1,259.00	
750 x 1200	432 x 900	23	300	1K0750.12005NF	€1,405.00	1K0750.12006NF	€1,405.00	1K0750.12007NF	€1,424.00	1K0750.12008NF	€1,405.00	
750 x 1660	432 x 1200	30	300	1K0750.16605NF	€1,504.00	1K0750.16606NF	€1,504.00	1K0750.16607NF	€1,523.00	1K0750.16608NF	€1,504.00	
900 x 900	812 x 500	19	700	1K0900.09005NF	€1,515.00	1K0900.09006NF	€1,515.00	1K0900.09007NF	€1,548.00	1K0900.09008NF	€1,515.00	
900 x 1200	812 x 900	23	700	1K0900.12005NF	€1,714.00	1K0900.12006NF	€1,714.00	1K0900.12007NF	€1,746.00	1K0900.12008NF	€1,714.00	
900 x 1660	812 x 1200	30	700	1K0900.16605NF	€1,831.00	1K0900.16606NF	€1,831.00	1K0900.16607NF	€1,864.00	1K0900.16608NF	€1,831.00	
1000 x 900	912 x 500	19	800	1K1000.09005NF	€1,593.00	1K1000.09006NF	€1,593.00	1K1000.09007NF	€1,622.00	1K1000.09008NF	€1,593.00	
1000 x 1200	912 x 900	23	800	1K1000.12005NF	€1,791.00	1K1000.12006NF	€1,791.00	1K1000.12007NF	€1,820.00	1K1000.12008NF	€1,791.00	
1000 x 1660	912 x 1200	30	800	1K1000.16605NF	€1,908.00	1K1000.16606NF	€1,908.00	1K1000.16607NF	€1,938.00	1K1000.16608NF	€1,908.00	
1200 x 900	1012 x 500	19	900	1K1200.09005NF	€1,751.00	1K1200.09006NF	€1,751.00	1K1200.09007NF	€1,780.00	1K1200.09008NF	€1,751.00	
1200 x 1200	1012 x 900	23	900	1K1200.12005NF	€2,044.00	1K1200.12006NF	€2,044.00	1K1200.12007NF	€2,073.00	1K1200.12008NF	€2,044.00	
1200 x 1660	1012 x 1200	30	900	1K1200.16605NF	€2,242.00	1K1200.16606NF	€2,242.00	1K1200.16607NF	€2,271.00	1K1200.16608NF	€2,242.00	
1500 x 900	1112 x 500	19	1000	1K1500.09005NF	€1,809.00	1K1500.09006NF	€1,809.00	1K1500.09007NF	€1,839.00	1K1500.09008NF	€1,809.00	
1500 x 1200	1112 x 900	23	1000	1K1500.12005NF	€2,101.00	1K1500.12006NF	€2,101.00	1K1500.12007NF	€2,132.00	1K1500.12008NF	€2,101.00	
1500 x 1660	1112 x 1200	30	1000	1K1500.16605NF	€2,301.00	1K1500.16606NF	€2,301.00	1K1500.16607NF	€2,329.00	1K1500.16608NF	€2,301.00	
1650 x 900	1312 x 500	19	1200	1K1650.09005NF	€2,018.00	1K1650.09006NF	€2,018.00	1K1650.09007NF	€2,059.00	1K1650.09008NF	€2,018.00	
1650 x 1200	1312 x 900	23	1200	1K1650.12005NF	€2,363.00	1K1650.12006NF	€2,363.00	1K1650.12007NF	€2,403.00	1K1650.12008NF	€2,363.00	
1650 x 1660	1312 x 1200	30	1200	1K1650.16605NF	€2,579.00	1K1650.16606NF	€2,579.00	1K1650.16607NF	€2,620.00	1K1650.16608NF	€2,579.00	



Hook  
Order Ref **WM1840.0000**  
RRP EX VAT **€21.00**

Linear Drain Strainer  
Order Ref **WM1810.0010**  
RRP EX VAT **€25.00**

Less Cleaning Trap  
Order Ref **1820.0080**  
RRP EX VAT **€80.00**

Maintenance Kit  
Order Ref **WMMK**  
RRP EX VAT **€210.00**

Installation Kit  
Order Ref **WMSSIK**  
RRP EX VAT **€146.00**

Tanking Kit  
Order Ref **WMVS30.12K**  
RRP EX VAT **€167.00**

**ALL KITS INCLUDE**

A DRAIN – 96LTR / MIN  
 PVD DURABLE FINISH  
 PREFORMED SLOPE BOARD  
 12m<sup>2</sup> WATERPROOFING SYSTEM

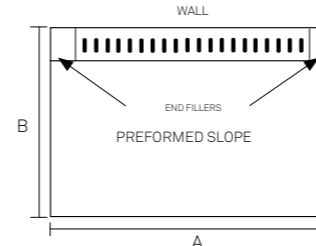
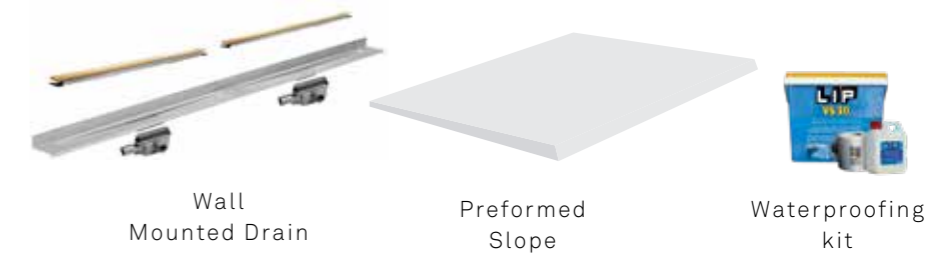

**DESIGN OPTIONS WITHOUT FRAME**



Size A	Size B	Minimum Size	Board Height	Drain Model	Highline Panel Brass Kit Order Ref	RRP EX VAT €	Highline Panel Copper Kit Order Ref	RRP EX VAT €	Highline Panel Black Kit Order Ref	RRP EX VAT €	Highline Panel Polished Stainless Kit Order Ref	RRP EX VAT €
1800 x 900	1509 x 500	19	1400	1K1800.09005NF	€2,700.00	1K1800.09006NF	€2,700.00	1K1800.09007NF	€2,766.00	1K1800.09008NF	€2,700.00	
1800 x 1200	1509 x 900	23	1400	1K1800.12005NF	€3,096.00	1K1800.12006NF	€3,096.00	1K1800.12007NF	€3,162.00	1K1800.12008NF	€3,096.00	
1800 x 1660	1509 x 1200	30	1400	1K1800.16605NF	€3,330.00	1K1800.16606NF	€3,330.00	1K1800.16607NF	€3,396.00	1K1800.16608NF	€3,330.00	
2000 x 900	1709 x 500	19	1600	1K2000.09005NF	€2,920.00	1K2000.09006NF	€2,920.00	1K2000.09007NF	€2,978.00	1K2000.09008NF	€2,920.00	
2000 x 1200	1709 x 900	23	1600	1K2000.12005NF	€3,316.00	1K2000.12006NF	€3,316.00	1K2000.12007NF	€3,374.00	1K2000.12008NF	€3,316.00	
2000 x 1660	1709 x 1200	30	1600	1K2000.16605NF	€3,550.00	1K2000.16606NF	€3,550.00	1K2000.16607NF	€3,610.00	1K2000.16608NF	€3,550.00	
2250 x 900	1909 x 500	19	1800	1K2250.09005NF	€3,148.00	1K2250.09006NF	€3,148.00	1K2250.09007NF	€3,206.00	1K2250.09008NF	€3,148.00	
2250 x 1200	1909 x 300	23	1800	1K2250.12005NF	€3,588.00	1K2250.12006NF	€3,588.00	1K2250.12007NF	€3,646.00	1K2250.12008NF	€3,588.00	
2250 x 1660	1909 x 1200	30	1800	1K2250.16605NF	€3,883.00	1K2250.16606NF	€3,883.00	1K2250.16607NF	€3,943.00	1K2250.16608NF	€3,883.00	
2500 x 900	2109 x 500	19	2000	1K2500.09005NF	€3,599.00	1K2500.09006NF	€3,599.00	1K2500.09007NF	€3,655.00	1K2500.09008NF	€3,599.00	
2500 x 1200	2109 x 900	23	2000	1K2500.12005NF	€4,173.00	1K2500.12006NF	€4,173.00	1K2500.12007NF	€4,235.00	1K2500.12008NF	€4,173.00	
2500 x 1660	2109 x 1200	30	2000	1K2500.16605NF	€4,476.00	1K2500.16606NF	€4,476.00	1K2500.16607NF	€4,538.00	1K2500.16608NF	€4,476.00	
2750 x 900	2509 x 500	19	2400	1K2750.09005NF	€4,372.00	1K2750.09006NF	€4,372.00	1K2750.09007NF	€4,449.00	1K2750.09008NF	€4,372.00	
2750 x 1200	2509 x 900	23	2400	1K2750.12005NF	€4,965.00	1K2750.12006NF	€4,965.00	1K2750.12007NF	€5,042.00	1K2750.12008NF	€4,965.00	
2750 x 1660	2509 x 1200	30	2400	1K2750.16605NF	€5,284.00	1K2750.16606NF	€5,284.00	1K2750.16607NF	€5,358.00	1K2750.16608NF	€5,284.00	



Hook  
Order Ref **WM1840.0000**  
RRP EX VAT **€25.00**

Linear Drain 2 x Strainers  
Order Ref **WM1810.0010.2**  
RRP EX VAT **€50.00**

Less Cleaning Trap  
Order Ref **1820.0080**  
RRP EX VAT **€80.00**

Maintenance Kit 2 x Strainers  
Order Ref **WMMK.2**  
RRP EX VAT **€235.00**

Installation Kit  
Order Ref **WMSSIK**  
RRP EX VAT **€146.00**

Tanking Kit  
Order Ref **WMVS30.12K**  
RRP EX VAT **€167.00**

**ALL KITS INCLUDE**

A DRAIN – 48LTR / MIN  
 PVD DURABLE FINISH  
 PREFORMED SLOPE BOARD  
 12m<sup>2</sup> WATERPROOFING SYSTEM

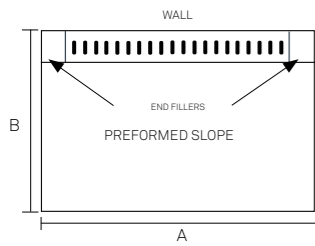
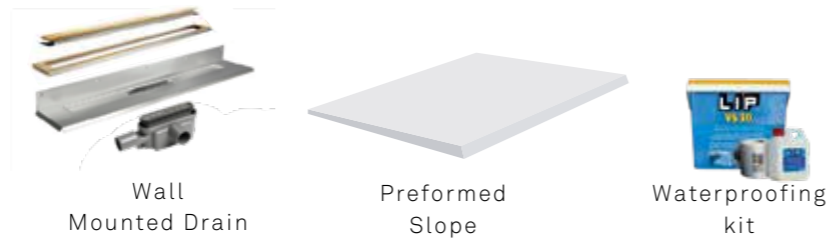

**DESIGN OPTIONS WITH FRAME**



Size A	Size B	Minimum Size	Board Height	Drain Model	Highline Panel and 15mm Frame Brass Kit Order Ref	RRP EX VAT €	Highline Panel and 15mm Frame Copper Kit Order Ref	RRP EX VAT €	Highline Panel and 15mm Frame Black Kit Order Ref	RRP EX VAT €	Highline Panel and 15mm Frame Polished Stainless Steel Kit Order Ref	RRP EX VAT €
750 x 900	432 x 500	19	300	1K0750.09005	1K0750.09005	€1,548.00	1K0750.09006	€1,548.00	1K0750.09007	€1,589.00	1K0750.09008	€1,548.00
750 x 1200	432 x 900	23	300	1K0750.12005	1K0750.12005	€1,696.00	1K0750.12006	€1,696.00	1K0750.12007	€1,735.00	1K0750.12008	€1,696.00
750 x 1660	432 x 1200	30	300	1K0750.16605	1K0750.16605	€1,795.00	1K0750.16606	€1,795.00	1K0750.16607	€1,834.00	1K0750.16608	€1,795.00
900 x 900	812 x 500	19	700	1K0900.09005	1K0900.09005	€1,988.00	1K0900.09006	€1,988.00	1K0900.09007	€2,059.00	1K0900.09008	€1,988.00
900 x 1200	812 x 900	23	700	1K0900.12005	1K0900.12005	€2,186.00	1K0900.12006	€2,186.00	1K0900.12007	€2,257.00	1K0900.12008	€2,186.00
900 x 1660	812 x 1200	30	700	1K0900.16605	1K0900.16605	€2,304.00	1K0900.16606	€2,304.00	1K0900.16607	€2,374.00	1K0900.16608	€2,304.00
1000 x 900	912 x 500	19	800	1K1000.09005	1K1000.09005	€2,081.00	1K1000.09006	€2,081.00	1K1000.09007	€2,147.00	1K1000.09008	€2,081.00
1000 x 1200	912 x 900	23	800	1K1000.12005	1K1000.12005	€2,279.00	1K1000.12006	€2,279.00	1K1000.12007	€2,345.00	1K1000.12008	€2,279.00
1000 x 1660	912 x 1200	30	800	1K1000.16605	1K1000.16605	€2,395.00	1K1000.16606	€2,395.00	1K1000.16607	€2,462.00	1K1000.16608	€2,395.00
1200 x 900	1012 x 500	19	900	1K1200.09005	1K1200.09005	€2,264.00	1K1200.09006	€2,264.00	1K1200.09007	€2,329.00	1K1200.09008	€2,264.00
1200 x 1200	1012 x 900	23	900	1K1200.12005	1K1200.12005	€2,558.00	1K1200.12006	€2,558.00	1K1200.12007	€2,623.00	1K1200.12008	€2,558.00
1200 x 1660	1012 x 1200	30	900	1K1200.16605	1K1200.16605	€2,755.00	1K1200.16606	€2,755.00	1K1200.16607	€2,821.00	1K1200.16608	€2,755.00
1500 x 900	1112 x 500	19	1000	1K1500.09005	1K1500.09005	€2,527.00	1K1500.09006	€2,527.00	1K1500.09007	€2,609.00	1K1500.09008	€2,527.00
1500 x 1200	1112 x 900	23	1000	1K1500.12005	1K1500.12005	€2,821.00	1K1500.12006	€2,821.00	1K1500.12007	€2,902.00	1K1500.12008	€2,821.00
1500 x 1660	1112 x 1200	30	1000	1K1500.16605	1K1500.16605	€3,019.00	1K1500.16606	€3,019.00	1K1500.16607	€3,099.00	1K1500.16608	€3,019.00
1650 x 900	1312 x 500	19	1200	1K1650.09005	1K1650.09005	€2,777.00	1K1650.09006	€2,777.00	1K1650.09007	€2,868.00	1K1650.09008	€2,777.00
1650 x 1200	1312 x 900	23	1200	1K1650.12005	1K1650.12005	€3,122.00	1K1650.12006	€3,122.00	1K1650.12007	€3,212.00	1K1650.12008	€3,122.00
1650 x 1660	1312 x 1200	30	1200	1K1650.16605	1K1650.16605	€3,338.00	1K1650.16606	€3,338.00	1K1650.16607	€3,429.00	1K1650.16608	€3,338.00



**ALL KITS INCLUDE**

A DRAIN – 96LTR / MIN  
 PVD DURABLE FINISH  
 PREFORMED SLOPE BOARD  
 12m<sup>2</sup> WATERPROOFING SYSTEM

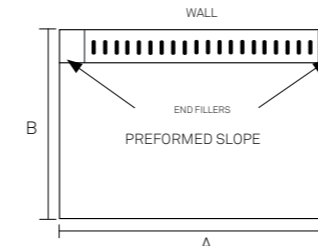
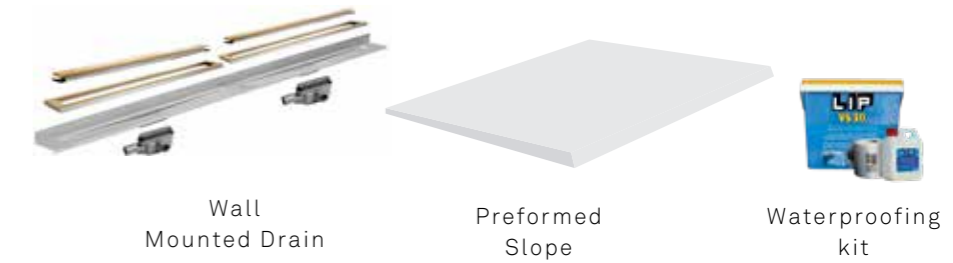

**DESIGN OPTIONS WITH FRAME**



Size A	Size B	Minimum Size	Board Height	Drain Model	Highline Panel and 15mm Frame Brass Kit Order Ref	RRP EX VAT €	Highline Panel and 15mm Frame Copper Kit Order Ref	RRP EX VAT €	Highline Panel and 15mm Frame Black Kit Order Ref	RRP EX VAT €	Highline Panel and 15mm Frame Polished Stainless Steel Kit Order Ref	RRP EX VAT €
1800 x 900	1509 x 500	19	1400	1K1800.09005	1K1800.09005	€3,646.00	1K1800.09006	€3,646.00	1K1800.09007	€3,786.00	1K1800.09008	€3,646.00
1800 x 1200	1509 x 900	23	1400	1K1800.12005	1K1800.12005	€4,042.00	1K1800.12006	€4,042.00	1K1800.12007	€4,180.00	1K1800.12008	€4,042.00
1800 x 1660	1509 x 1200	30	1400	1K1800.16605	1K1800.16605	€4,276.00	1K1800.16606	€4,276.00	1K1800.16607	€4,416.00	1K1800.16608	€4,276.00
2000 x 900	1709 x 500	19	1600	1K2000.09005	1K2000.09005	€3,896.00	1K2000.09006	€3,896.00	1K2000.09007	€4,028.00	1K2000.09008	€3,896.00
2000 x 1200	1709 x 900	23	1600	1K2000.12005	1K2000.12005	€4,290.00	1K2000.12006	€4,290.00	1K2000.12007	€4,422.00	1K2000.12008	€4,290.00
2000 x 1660	1709 x 1200	30	1600	1K2000.16605	1K2000.16605	€4,526.00	1K2000.16606	€4,526.00	1K2000.16607	€4,657.00	1K2000.16608	€4,526.00
2250 x 900	1909 x 500	19	1800	1K2250.09005	1K2250.09005	€4,174.00	1K2250.09006	€4,174.00	1K2250.09007	€4,306.00	1K2250.09008	€4,174.00
2250 x 1200	1909 x 900	23	1800	1K2250.12005	1K2250.12005	€4,614.00	1K2250.12006	€4,614.00	1K2250.12007	€4,746.00	1K2250.12008	€4,614.00
2250 x 1660	1909 x 1200	30	1800	1K2250.16605	1K2250.16605	€4,911.00	1K2250.16606	€4,911.00	1K2250.16607	€5,043.00	1K2250.16608	€4,911.00
2500 x 900	2109 x 500	19	2000	1K2500.09005	1K2500.09005	€4,700.00	1K2500.09006	€4,700.00	1K2500.09007	€4,833.00	1K2500.09008	€4,700.00
2500 x 1200	2109 x 900	23	2000	1K2500.12005	1K2500.12005	€5,699.00	1K2500.12006	€5,699.00	1K2500.12007	€5,867.00	1K2500.12008	€5,699.00
2500 x 1660	2109 x 1200	30	2000	1K2500.16605	1K2500.16605	€6,007.00	1K2500.16606	€6,007.00	1K2500.16607	€6,168.00	1K2500.16608	€6,007.00
2750 x 900	2509 x 500	19	2400	1K2750.09005	1K2750.09005	€5,993.00	1K2750.09006	€5,993.00	1K2750.09007	€6,175.00	1K2750.09008	€5,993.00
2750 x 1200	2509 x 900	23	2400	1K2750.12005	1K2750.12005	€6,593.00	1K2750.12006	€6,593.00	1K2750.12007	€6,775.00	1K2750.12008	€6,593.00
2750 x 1660	2509 x 1200	30	2400	1K2750.16605	1K2750.16605	€6,915.00	1K2750.16606	€6,915.00	1K2750.16607	€7,097.00	1K2750.16608	€6,915.00



# UniSlope® | 2K

**ALL KITS INCLUDE**

A DRAIN – 48LTR / MIN  
 PREFORMED SLOPE BOARD  
 12m<sup>2</sup> WATERPROOFING SYSTEM

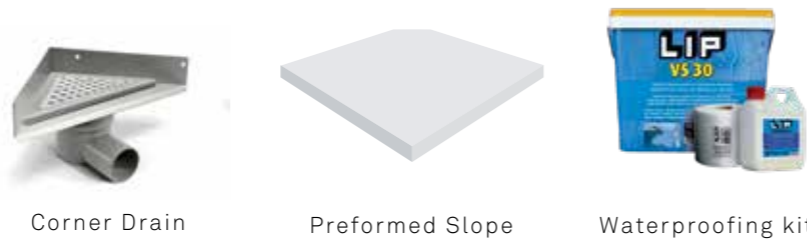

Corner Drain

Preformed Slope

Waterproofing kit

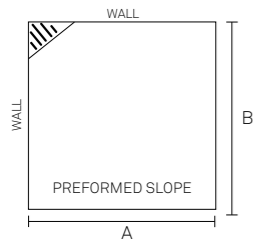

**DESIGN OPTIONS**



Size A	Size B	Minimum Size	Board Height	Drain Model	Anniversario Grate and 12mm Frame Kit Order Ref	RRP EX VAT €	Column Grate and 12mm Frame Kit Order Ref	RRP EX VAT €	Highline Custom Kit Order Ref	RRP EX VAT €	Highline Panel and 15mm Frame Kit Order Ref	RRP EX VAT €
900 x 900	500 x 500	19	Corner	2K0900.09001	€1,289.00	2K0900.09011	€1,289.00	2K0900.09002	€1,385.00	2K0900.09003	€1,499.00	
1200 x 1200	900 x 900	23	Corner	2K1200.12001	€1,636.00	2K1200.12011	€1,636.00	2K1200.12002	€1,742.00	2K1200.12003	€1,847.00	
1500 x 1500	1200 x 1200	30	Corner	2K1500.15001	€1,820.00	2K1500.15011	€1,820.00	2K1500.15002	€1,925.00	2K1500.15003	€2,031.00	

# UniSlope® | 3K

**ALL KITS INCLUDE**

A DRAIN – 48LTR / MIN  
 PVD DURABLE FINISH  
 PREFORMED SLOPE BOARD  
 12m<sup>2</sup> WATERPROOFING SYSTEM

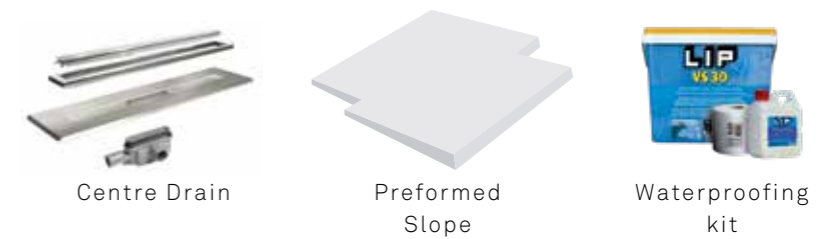

Centre Drain

Preformed Slope

Waterproofing kit

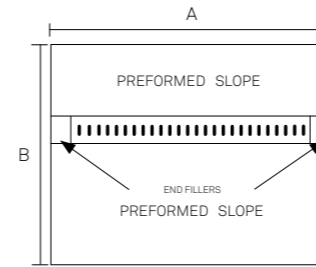

**DESIGN OPTIONS**



Size A	Size B	Minimum Size	Board Height	Drain Model	Anniversario Grate and 12mm Frame Kit Order Ref	RRP EX VAT €	Highline Custom Kit Order Ref	RRP EX VAT €	Highline Panel and 15mm Frame Kit Order Ref	RRP EX VAT €	Highline Cassette and 15mm Frame Kit Order Ref	RRP EX VAT €
1000 x 1728	812 x 500	19	700	3K1000.17281	€1,608.00	3K1000.17282	€1,636.00	3K1000.17283	€2,022.00	3K1000.17284	€1,944.00	
1000 x 2028	812 x 1728	23	700	3K1000.20281	€1,802.00	3K1000.20282	€1,831.00	3K1000.20283	€2,216.00	3K1000.20284	€2,139.00	
1000 x 2488	812 x 2028	30	700	3K1000.24881	€1,919.00	3K1000.24882	€1,949.00	3K1000.24883	€2,332.00	3K1000.24884	€2,257.00	
1500 x 1728	1312 x 500	19	1200	3K1500.17281	€2,180.00	3K1500.17282	€2,211.00	3K1500.17283	€2,682.00	3K1500.17284	€2,626.00	
1500 x 2028	1312 x 1728	23	1200	3K1500.20281	€2,466.00	3K1500.20282	€2,499.00	3K1500.20283	€2,967.00	3K1500.20284	€2,913.00	
1500 x 2488	1312 x 2028	30	1200	3K1500.24881	€2,662.00	3K1500.24882	€2,697.00	3K1500.24883	€3,165.00	3K1500.24884	€3,110.00	

**DESIGN OPTIONS WITHOUT FRAME**



Size A	Size B	Minimum Size	Board Height	Drain Model	Highline Panel Brass Kit Order Ref	RRP EX VAT €	Highline Panel Copper Kit Order Ref	RRP EX VAT €	Highline Panel Black Kit Order Ref	RRP EX VAT €	Highline Panel Polished Stainless Steel Kit Order Ref	RRP EX VAT €
1000 x 1728	812 x 500	19	700	3K1000.17285NF	€1,806.00	3K1000.17286NF	€1,806.00	3K1000.17287NF	€1,839.00	3K1000.17288NF	€1,806.00	
1000 x 2028	812 x 1728	23	700	3K1000.20285NF	€1,999.00	3K1000.20286NF	€1,999.00	3K1000.20287NF	€2,033.00	3K1000.20288NF	€1,999.00	
1000 x 2488	812 x 2028	30	700	3K1000.24885NF	€2,118.00	3K1000.24886NF	€2,118.00	3K1000.24887NF	€2,150.00	3K1000.24888NF	€2,118.00	
1500 x 1728	1312 x 500	19	1200	3K1500.17285NF	€2,411.00	3K1500.17286NF	€2,411.00	3K1500.17287NF	€2,451.00	3K1500.17288NF	€2,411.00	
1500 x 2028	1312 x 1728	23	1200	3K1500.20285NF	€2,697.00	3K1500.20286NF	€2,697.00	3K1500.20287NF	€2,736.00	3K1500.20288NF	€2,697.00	
1500 x 2488	1312 x 2028	30	1200	3K1500.24885NF	€2,895.00	3K1500.24886NF	€2,895.00	3K1500.24887NF	€2,934.00	3K1500.24888NF	€2,895.00	



Hook  
 Order Ref  
**WM1840.0000**  
 RRP EX VAT  
 €21.00

Corner Drain Strainer  
 Order Ref  
**WM2811.0010**  
 RRP EX VAT  
 €25.00

Maintenance Kit  
 Order Ref  
**WMMK.3**  
 RRP EX VAT  
 €210.00

Installation Kit  
 Order Ref  
**WMSSIK**  
 RRP EX VAT  
 €148.00

Tanking Kit  
 Order Ref  
**WMVS30.12K**  
 RRP EX VAT  
 €167.00



Hook  
 Order Ref  
**WM1840.0000**  
 RRP EX VAT  
 €21.00

Linear Drain Strainer  
 Order Ref  
**WM1810.0010**  
 RRP EX VAT  
 €25.00

Less Cleaning Trap  
 Order Ref  
**1820.0080**  
 RRP EX VAT  
 €80.00

Maintenance Kit  
 Order Ref  
**WMMK**  
 RRP EX VAT  
 €210.00

Installation Kit  
 Order Ref  
**WMSSIK**  
 RRP EX VAT  
 €146.00

Tanking Kit  
 Order Ref  
**WMVS30.12K**  
 RRP EX VAT  
 €167.00

### ALL KITS INCLUDE

A DRAIN – 48LTR / MIN  
PVD DURABLE FINISH  
PREFORMED SLOPE BOARD  
12m<sup>2</sup> WATERPROOFING SYSTEM



Centre Drain

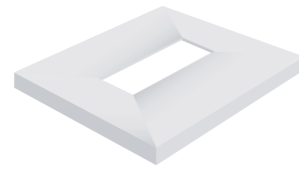

Preformed Slope



Waterproofing kit

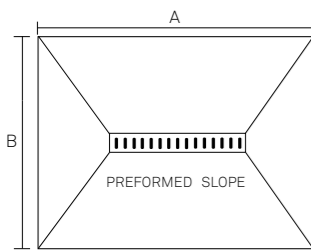

### DESIGN OPTIONS



Size A	Size B	Minimum Size	Board Height	Drain Model	Anniversario Grate and 12mm Frame Kit Order Ref	RRP EX VAT €	Highline Custom Kit Order Ref	RRP EX VAT €	Highline Panel and 15mm Frame Kit Order Ref	RRP EX VAT €	Highline Cassette and 15mm Frame Kit Order Ref	RRP EX VAT €
900 x 900	800 x 600	19	300	4K0900.09001	€1,352.00	4K0900.09002	€1,346.00	4K0900.09003	€1,647.00	4K0900.09004	€1,583.00	
1200 x 900	900 x 600	19	700	4K1200.09001	€1,517.00	4K1200.09002	€1,545.00	4K1200.09003	€1,913.00	4K1200.09004	€1,839.00	
1500 x 1000	1200 x 600	19	700	4K1500.10001	€1,488.00	4K1500.10002	€1,517.00	4K1500.10003	€1,885.00	4K1500.10004	€1,811.00	

### DESIGN OPTIONS WITHOUT FRAME



Size A	Size B	Minimum Size	Board Height	Drain Model	Highline Panel Brass Kit Order Ref	RRP EX VAT €	Highline Panel Copper Kit Order Ref	RRP EX VAT €	Highline Panel Black Kit Order Ref	RRP EX VAT €	Highline Panel Polished Stainless Steel Kit Order Ref	RRP EX VAT €
900 x 900	800 x 600	19	300	4K0900.09005NF	€1,407.00	4K0900.09006NF	€1,407.00	4K0900.09007NF	€1,424.00	4K0900.09008NF	€1,407.00	
1200 x 900	900 x 600	19	700	4K1200.09005NF	€1,624.00	4K1200.09006NF	€1,624.00	4K1200.09007NF	€1,701.00	4K1200.09008NF	€1,624.00	
1500 x 1000	1200 x 600	19	700	4K1500.10005NF	€1,598.00	4K1500.10006NF	€1,598.00	4K1500.10007NF	€1,675.00	4K1500.10008NF	€1,598.00	

Hook Order Ref <b>WM1840.0000</b> RRP EX VAT €21.00	Linear Drain Strainer Order Ref <b>WM1810.0010</b> RRP EX VAT €25.00	Less Cleaning Trap Order Ref <b>1820.0080</b> RRP EX VAT €80.00	Maintenance Kit Order Ref <b>WMMK</b> RRP EX VAT €210.00	Installation Kit Order Ref <b>WMSSIK</b> RRP EX VAT €146.00	Tanking Kit Order Ref <b>WMVS30.12K</b> RRP EX VAT €167.00	Hook Order Ref <b>WM1840.0000</b> RRP EX VAT €21.00	Linear Drain 1 x Strainer Order Ref <b>WM1810.0010</b> RRP EX VAT €25.00	Linear Drain 2 x Strainers Order Ref <b>WM1810.0010.2</b> RRP EX VAT €50.00	Less Cleaning Trap Order Ref <b>1820.0080</b> RRP EX VAT €80.00	Maintenance Kit 1 x Strainer Order Ref <b>WMMK</b> RRP EX VAT €210.00	Maintenance Kit 2 x Strainers Order Ref <b>WMMK.2</b> RRP EX VAT €235.00	Installation Kit Order Ref <b>WMSSIK</b> RRP EX VAT €146.00	Tanking Kit Order Ref <b>WMVS30.12K</b> RRP EX VAT €167.00

# WALL MOUNTED UNIDRAIN®

### CLASSICLINE

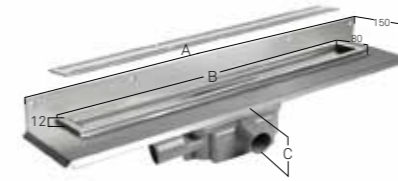

Model No.	A Structural Length	B Visual Length	C Drain Depth	Anniversario Grate 12mm Frame Kit Order Ref	RRP EX VAT €	Square Grate 12mm Frame Kit Order Ref	RRP EX VAT €
300	432	300	98	1004.0300K1	€588.00	1004.0300K1SQ	€588.00
600	712	600	102	1004.0600K1	€731.00	N/A	N/A
700	812	700	103	1004.0700K1	€731.00	1004.0700K1SQ	€731.00
800	912	800	104	1004.0800K1	€767.00	1004.0800K1SQ	€767.00
900	1012	900	105	1004.0900K1	€801.00	1004.0900K1SQ	€801.00
1000	1112	1000	106	1004.1000K1	€855.00	1004.1000K1SQ	€855.00
1200	1312	1200	108	1004.1200K1	€1,036.00	1004.1200K1SQ	€1,036.00
1400	1509	1400	103	1004.1400K1	€1,487.00	1004.1400K1SQ	€1,487.00
1600	1709	1600	104	1004.1600K1	€1,625.00	1004.1600K1SQ	€1,625.00
1800	1909	1800	105	1004.1800K1	€1,751.00	1004.1800K1SQ	€1,751.00
2000	2109	2000	106	1004.2000K1	€1,974.00	1004.2000K1SQ	€1,974.00
2400	2509	2400	108	1004.2400K1	€2,724.00	1004.2400K1SQ	€2,724.00

Model No.	A Structural Length	B Visual Length	C Drain Depth	Stripe Grate 12mm Frame Kit Order Ref	RRP EX VAT €	Column Grate 12mm Frame Kit Order Ref	RRP EX VAT €
300	432	300	98	1004.0300K1ST	€588.00	1004.0300K1CL	€588.00
600	712	600	102	N/A	N/A	1004.0600K1CL	€731.00
700	812	700	103	1004.0700K1ST	€731.00	1004.0700K1CL	€731.00
800	912	800	104	1004.0800K1ST	€767.00	1004.0800K1CL	€767.00
900	1012	900	105	1004.0900K1ST	€801.00	1004.0900K1CL	€801.00
1000	1112	1000	106	1004.1000K1ST	€855.00	1004.1000K1CL	€855.00
1200	1312	1200	108	1004.1200K1ST	€1,036.00	1004.1200K1CL	€1,036.00
1400	1509	1400	103	1004.1400K1ST	€1,487.00	1004.1400K1CL	€1,487.00
1600	1709	1600	104	1004.1600K1ST	€1,625.00	1004.1600K1CL	€1,625.00
1800	1909	1800	105	1004.1800K1ST	€1,751.00	1004.1800K1CL	€1,751.00
2000	2109	2000	106	1004.2000K1ST	€1,974.00	1004.2000K1CL	€1,974.00
2400	2509	2400	108	1004.2400K1ST	€2,724.00	1004.2400K1CL	€2,724.00

# WALL MOUNTED UNIDRAIN®

## HIGHLINE CUSTOM



Model No.	A Structural Length	B Visual Length	C Drain Depth	Highline Custom Kit Order Ref	RRP EX VAT €
300	432	253	98	1004.0300K2	€599.00
600	712	533	102	1004.0600K2	€768.00
700	812	633	103	1004.0700K2	€768.00
800	912	733	104	1004.0800K2	€830.00
900	1012	833	105	1004.0900K2	€871.00
1000	1112	933	106	1004.1000K2	€933.00
1200	1312	1133	108	1004.1200K2	€1,097.00
1400	1509	633x2	103	1004.1400K2	€1,589.00
1600	1709	733x2	104	1004.1600K2	€1,751.00
1800	1909	833x2	105	1004.1800K2	€1,889.00
2000	2109	933x2	106	1004.2000K2	€2,191.00
2400	2509	1133x2	108	1004.2400K2	€2,812.00

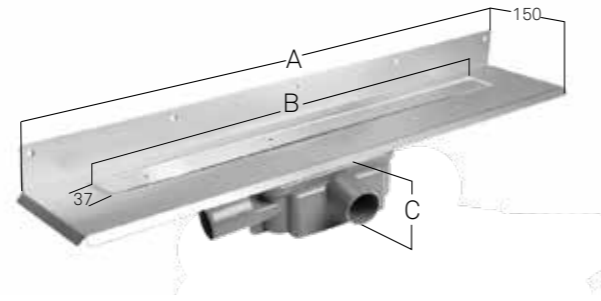



# WALL MOUNTED UNIDRAIN®

## HIGHLINE PANEL

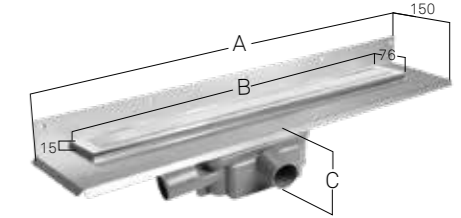
Model No	A Structural Length	B Visual Length	C Drain Depth	Highline Stainless Steel Panel and 15mm Frame Kit Order Ref	RRP EX VAT €	Highline Brass Panel and 15mm Frame Kit Order Ref	RRP EX VAT €
300	432	300	98	1004.0300K3	€888.00	1004.0300K5	€1,028.00
700	812	700	103	1004.0700K3	€1,131.00	1004.0700K5	€1,424.00
800	912	800	104	1004.0800K3	€1,171.00	1004.0800K5	€1,515.00
900	1012	900	105	1004.0900K3	€1,238.00	1004.0900K5	€1,586.00
1000	1112	1000	106	1004.1000K3	€1,314.00	1004.1000K5	€1,850.00
1200	1312	1200	108	1004.1200K3	€1,509.00	1004.1200K5	€2,054.00
1400	1509	1400	103	1004.1400K3	€2,285.00	1004.1400K5	€2,871.00
1600	1709	1600	104	1004.1600K3	€2,431.00	1004.1600K5	€3,122.00
1800	1909	1800	105	1004.1800K3	€2,623.00	1004.1800K5	€3,319.00
2000	2109	2000	106	1004.2000K3	€3,038.00	1004.2000K5	€4,146.00
2400	2509	2400	108	1004.2400K3	€3,749.00	1004.2400K5	€4,902.00

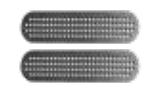

Model No	A Structural Length	B Visual Length	C Drain Depth	Highline Copper Panel and 15mm Frame Kit Order Ref	RRP EX VAT €	Highline Black Panel and 15mm Frame Kit Order Ref	RRP EX VAT €	Highline Polished Stainless Steel and 15mm Frame Kit Order Ref	RRP EX VAT €
300	432	300	98	1004.0300K6	€1,028.00	1004.0300K7	€1,069.00	1004.0300K8	€1,028.00
700	812	700	103	1004.0700K6	€1,424.00	1004.0700K7	€1,494.00	1004.0700K8	€1,424.00
800	912	800	104	1004.0800K6	€1,515.00	1004.0800K7	€1,582.00	1004.0800K8	€1,515.00
900	1012	900	105	1004.0900K6	€1,586.00	1004.0900K7	€1,650.00	1004.0900K8	€1,586.00
1000	1112	1000	106	1004.1000K6	€1,850.00	1004.1000K7	€1,930.00	1004.1000K8	€1,850.00
1200	1312	1200	108	1004.1200K6	€2,054.00	1004.1200K7	€2,147.00	1004.1200K8	€2,054.00
1400	1509	1400	103	1004.1400K6	€2,871.00	1004.1400K7	€3,012.00	1004.1400K8	€2,871.00
1600	1709	1600	104	1004.1600K6	€3,122.00	1004.1600K7	€3,254.00	1004.1600K8	€3,122.00
1800	1909	1800	105	1004.1800K6	€3,319.00	1004.1800K7	€3,452.00	1004.1800K8	€3,319.00
2000	2109	2000	106	1004.2000K6	€4,146.00	1004.2000K7	€4,304.00	1004.2000K8	€4,146.00
2400	2509	2400	108	1004.2400K6	€4,902.00	1004.2400K7	€5,075.00	1004.2400K8	€4,902.00

							
Hook Order Ref <b>WM1840.0000</b> RRP EX VAT <b>€21.00</b>	Linear Drain 1 x Strainer Order Ref <b>WM1810.0010</b> RRP EX VAT <b>€25.00</b>	Linear Drain 2 x Strainers Order Ref <b>WM1810.0010.2</b> RRP EX VAT <b>€50.00</b>	Less Cleaning Trap Order Ref <b>1820.0080</b> RRP EX VAT <b>€80.00</b>	Maintenance Kit 1 x Strainer Order Ref <b>WMMK</b> RRP EX VAT <b>€210.00</b>	Maintenance Kit 2 x Strainers Order Ref <b>WMMK.2</b> RRP EX VAT <b>€235.00</b>	Installation Kit Order Ref <b>WMSSIK</b> RRP EX VAT <b>€146.00</b>	Tanking Kit Order Ref <b>WMVS30.12K</b> RRP EX VAT <b>€167.00</b>

							
Hook Order Ref <b>WM1840.0000</b> RRP EX VAT <b>€21.00</b>	Linear Drain 1 x Strainer Order Ref <b>WM1810.0010</b> RRP EX VAT <b>€25.00</b>	Linear Drain 2 x Strainers Order Ref <b>WM1810.0010.2</b> RRP EX VAT <b>€50.00</b>	Less Cleaning Trap Order Ref <b>1820.0080</b> RRP EX VAT <b>€80.00</b>	Maintenance Kit 1 x Strainer Order Ref <b>WMMK</b> RRP EX VAT <b>€210.00</b>	Maintenance Kit 2 x Strainers Order Ref <b>WMMK.2</b> RRP EX VAT <b>€235.00</b>	Installation Kit Order Ref <b>WMSSIK</b> RRP EX VAT <b>€146.00</b>	Tanking Kit Order Ref <b>WMVS30.12K</b> RRP EX VAT <b>€167.00</b>

# WALL MOUNTED UNIDRAIN®

## HIGHLINE CASSETTE



Model No	A Structural Length	B Visual Length	C Drain Depth	Highline Cassette and 15mm Frame Kit Order Ref	RRP EX VAT €
300	432	300	98	1004.0300K4	€823.00
700	812	700	103	1004.0700K4	€1,054.00
800	912	800	104	1004.0800K4	€1,111.00
900	1012	900	105	1004.0900K4	€1,174.00
1000	1112	1000	106	1004.1000K4	€1,256.00
1200	1312	1200	108	1004.1200K4	€1,454.00
1400	1509	1400	103	1004.1400K4	€2,132.00
1600	1709	1600	104	1004.1600K4	€2,315.00
1800	1909	1800	105	1004.1800K4	€2,499.00
2000	2109	2000	106	1004.2000K4	€2,903.00
2400	2509	2400	108	1004.2400K4	€3,619.00

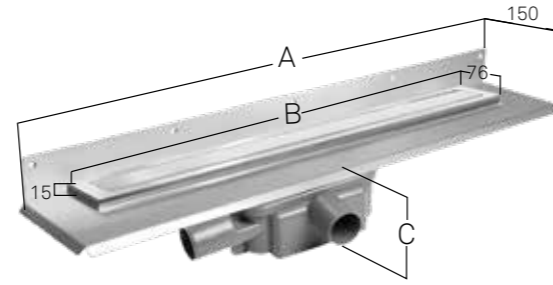

Hook  
Order Ref  
**WM1840.0000**  
RRP EX VAT  
**€21.00**



Linear Drain  
1 x Strainer  
Order Ref  
**WM1810.0010**  
RRP EX VAT  
**€25.00**



Linear Drain  
2 x Strainers  
Order Ref  
**WM1810.0010.2**  
RRP EX VAT  
**€50.00**



Less Cleaning Trap  
Order Ref  
**1820.0080**  
RRP EX VAT  
**€80.00**



Maintenance Kit  
1 x Strainer  
Order Ref  
**WMMK**  
RRP EX VAT  
**€210.00**



Maintenance Kit  
2 x Strainers  
Order Ref  
**WMMK.2**  
RRP EX VAT  
**€235.00**



Installation Kit  
Order Ref  
**WMSSIK**  
RRP EX VAT  
**€146.00**



Tanking Kit  
Order Ref  
**WMVS30.12K**  
RRP EX VAT  
**€167.00**

# UNIDRAIN®

## CORNER DRAIN

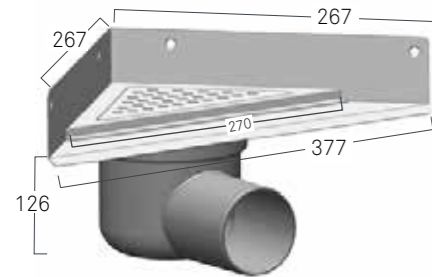

Model No	Structural Length	Visual Length	Drain Depth	Anniversario Grate 12mm Frame Kit Order Ref	RRP EX VAT €	Highline Custom Kit Order Ref	RRP EX VAT €	Highline Panel 15mm Frame Kit Order Ref	RRP EX VAT €
Corner	268	270	126	2001.0200K1	€578.00	2001.0200K2	€604.00	2001.0200K3	€778.00

**NB:** SEE PAGE 130 IN BROCHURE FOR HIGHLINE CUSTOM DIMENSIONS.



Hook  
Order Ref  
**WM1840.0000**  
RRP EX VAT  
**€21.00**



Corner Drain Strainer  
Order Ref  
**WM2811.0010**  
RRP EX VAT  
**€25.00**



Maintenance Kit  
Order Ref  
**WMMK.3**  
RRP EX VAT  
**€210.00**



Installation Kit  
Order Ref  
**WMSSIK**  
RRP EX VAT  
**€148.00**



Tanking Kit  
Order Ref  
**WMVS30.12K**  
RRP EX VAT  
**€167.00**

# CENTRE FLOOR UNIDRAIN®

## CLASSICLINE

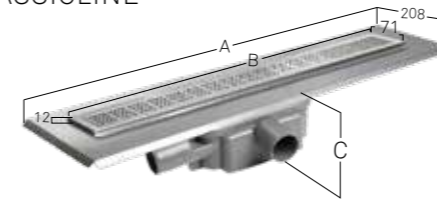

Model No.	A Structural Length	B Visual Length	C Drain Depth	Anniversario Grate 12mm Frame Kit Order Ref	RRP EX VAT €	Square Grate 12mm Frame Kit Order Ref	RRP EX VAT €
300	432	300	98	3004.0300K1	€601.00	3004.0300K1SQ	€601.00
700	812	700	103	3004.0700K1	€757.00	3004.0700K1SQ	€757.00
800	912	800	104	3004.0800K1	€798.00	3004.0800K1SQ	€798.00
900	1012	900	105	3004.0900K1	€847.00	3004.0900K1SQ	€847.00
1000	1112	1000	106	3004.1000K1	€928.00	3004.1000K1SQ	€928.00
1200	1312	1200	108	3004.1200K1	€1,061.00	3004.1200K1SQ	€1,061.00

Model No.	A Structural Length	B Visual Length	C Drain Depth	Stripe Grate 12mm Frame Kit Order Ref	RRP EX VAT €	Column Grate 12mm Frame Kit Order Ref	RRP EX VAT €
300	432	300	98	3004.0300K1ST	€601.00	3004.0300K1CL	€601.00
700	812	700	103	3004.0700K1ST	€757.00	3004.0700K1CL	€757.00
800	912	800	104	3004.0800K1ST	€798.00	3004.0800K1CL	€798.00
900	1012	900	105	3004.0900K1ST	€847.00	3004.0900K1CL	€847.00
1000	1112	1000	106	3004.1000K1ST	€928.00	3004.1000K1CL	€928.00
1200	1312	1200	108	3004.1200K1ST	€1,061.00	3004.1200K1CL	€1,061.00



Hook  
Order Ref  
**WM1840.0000**  
RRP EX VAT  
**€21.00**



Linear Drain  
1 x Strainer  
Order Ref  
**WM1810.0010**  
RRP EX VAT  
**€25.00**



Linear Drain  
2 x Strainers  
Order Ref  
**WM1810.0010.2**  
RRP EX VAT  
**€50.00**



Less Cleaning Trap  
Order Ref  
**1820.0080**  
RRP EX VAT  
**€80.00**



Maintenance Kit  
Order Ref  
**WMMK**  
RRP EX VAT  
**€210.00**



Maintenance Kit  
Order Ref  
**WMMK.2**  
RRP EX VAT  
**€235.00**



Installation Kit  
Order Ref  
**WMSSIK**  
RRP EX VAT  
**€146.00**



Tanking Kit  
Order Ref  
**WMVS30.12K**  
RRP EX VAT  
**€167.00**

# CENTRE FLOOR UNIDRAIN®

18

## HIGHLINE CUSTOM



Model No	A Structural Length	B Visual Length	C Drain Depth	Highline Custom Kit Order Ref	RRP EX VAT €
300	432	253	98	3004.0300K2	€594.00
700	812	633	103	3004.0700K2	€768.00
800	912	733	104	3004.0800K2	€834.00
900	1012	833	105	3004.0900K2	€887.00
1000	1112	933	106	3004.1000K2	€977.00
1200	1312	1133	108	3004.1200K2	€1,091.00

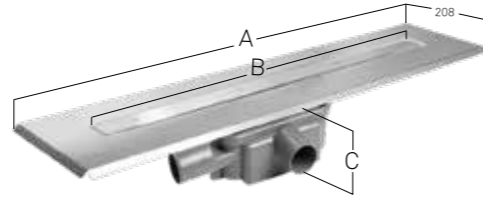

# CENTRE FLOOR UNIDRAIN®

## HIGHLINE PANEL WITHOUT FRAME



Model No	A Structural Length	B Visual Length	C Drain Depth	Highline Stainless Steel Panel Kit Order Ref	RRP EX VAT €	Highline Brass Panel Kit Order Ref	RRP EX VAT €
300	432	253	98	3004.0300K3NF	€685.00	3004.0300K5NF	€721.00
700	812	633	103	3004.0700K3NF	€874.00	3004.0700K5NF	€938.00
800	912	733	104	3004.0800K3NF	€905.00	3004.0800K5NF	€1,015.00
900	1012	833	105	3004.0900K3NF	€964.00	3004.0900K5NF	€1,071.00
1000	1112	933	106	3004.1000K3NF	€1,048.00	3004.1000K5NF	€1,158.00
1200	1312	1133	108	3004.1200K3NF	€1,154.00	3004.1200K5NF	€1,271.00

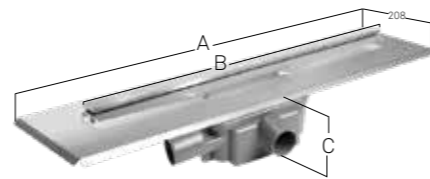

Model No	A Structural Length	B Visual Length	C Drain Depth	Highline Copper Panel Kit Order Ref	RRP EX VAT €	Highline Black Panel Kit Order Ref	RRP EX VAT €	Highline Polished Stainless Steel Kit Order Ref	RRP EX VAT €
300	432	253	98	3004.0300K6NF	€721.00	3004.0300K7NF	€737.00	3004.0300K8NF	€721.00
700	812	633	103	3004.0700K6NF	€938.00	3004.0700K7NF	€967.00	3004.0700K8NF	€938.00
800	912	733	104	3004.0800K6NF	€1,015.00	3004.0800K7NF	€1,041.00	3004.0800K8NF	€1,015.00
900	1012	833	105	3004.0900K6NF	€1,071.00	3004.0900K7NF	€1,097.00	3004.0900K8NF	€1,071.00
1000	1112	933	106	3004.1000K6NF	€1,158.00	3004.1000K7NF	€1,184.00	3004.1000K8NF	€1,158.00
1200	1312	1133	108	3004.1200K6NF	€1,271.00	3004.1200K7NF	€1,307.00	3004.1200K8NF	€1,271.00

 Hook Order Ref <b>WM1840.0000</b> RRP EX VAT <b>€21.00</b>	 Linear Drain Strainer Order Ref <b>WM1810.0010</b> RRP EX VAT <b>€25.00</b>	 Less Cleaning Trap Order Ref <b>1820.0080</b> RRP EX VAT <b>€80.00</b>	 Maintenance Kit Order Ref <b>WMMK</b> RRP EX VAT <b>€210.00</b>	 Installation Kit Order Ref <b>WMSSIK</b> RRP EX VAT <b>€146.00</b>	 Tanking Kit Order Ref <b>WMVS30.12K</b> RRP EX VAT <b>€167.00</b>
---	--	---	---	---	--

# CENTRE FLOOR UNIDRAIN®

19

## HIGHLINE PANEL WITH FRAME



Model No	A Structural Length	B Visual Length	C Drain Depth	Highline Brushed Stainless Steel Panel 15mm Frame Kit Order Ref	RRP EX VAT €
300	432	300	98	3004.0300K3	€880.00
700	812	700	103	3004.0700K3	€1,135.00
800	912	800	104	3004.0800K3	€1,184.00
900	1012	900	105	3004.0900K3	€1,268.00
1000	1112	1000	106	3004.1000K3	€1,371.00
1200	1312	1200	108	3004.1200K3	€1,517.00

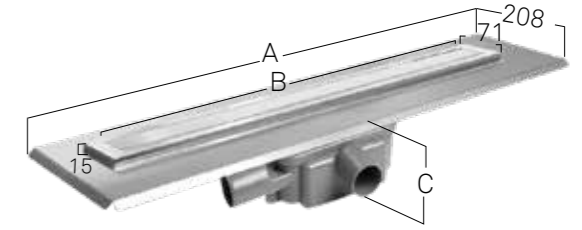

# CENTRE FLOOR UNIDRAIN®

## HIGHLINE CASSETTE WITH FRAME



Model No	A Structural Length	B Visual Length	C Drain Depth	Highline Cassette 15mm Frame Kit Order Ref	RRP EX VAT €
300	432	300	98	3004.0300K4	€821.00
700	812	700	103	3004.0700K4	€1,064.00
800	912	800	104	3004.0800K4	€1,131.00
900	1012	900	105	3004.0900K4	€1,210.00
1000	1112	1000	106	3004.1000K4	€1,317.00
1200	1312	1200	108	3004.1200K4	€1,468.00

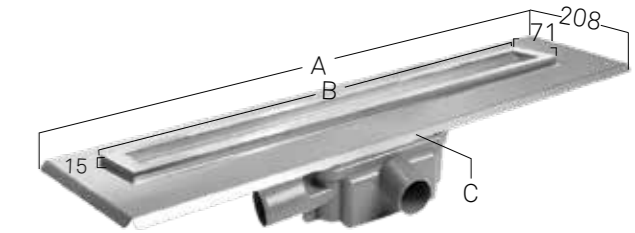

 Hook Order Ref <b>WM1840.0000</b> RRP EX VAT <b>€21.00</b>	 Linear Drain Strainer Order Ref <b>WM1810.0010</b> RRP EX VAT <b>€25.00</b>	 Less Cleaning Trap Order Ref <b>1820.0080</b> RRP EX VAT <b>€80.00</b>	 Maintenance Kit Order Ref <b>WMMK</b> RRP EX VAT <b>€210.00</b>	 Installation Kit Order Ref <b>WMSSIK</b> RRP EX VAT <b>€146.00</b>	 Tanking Kit Order Ref <b>WMVS30.12K</b> RRP EX VAT <b>€167.00</b>
---	--	---	--	---	--

# UNIDRAIN® SQUARE

## HORIZONTAL

A Structural Length	B Visual Length	C Drain Depth	Square Drain Anniversario Kit Order Ref	RRP EX Vat €
221	100 x 100	119	WM82100.K1	€444.00

CHECK STOCK AVAILABILITY ON ANNIVERSARIO

A Structural Length	B Visual Length	C Drain Depth	Square Drain Column Kit Order Ref	RRP EX Vat €
221	100 X 100	119	WM82100.K1CO	€444.00

A Structural Length	B Visual Length	C Drain Depth	Square Drain Column Kit Order Ref	RRP EX Vat €
221	150 x 150	119	WM82150.K1CO	€457.00

A Structural Length	B Visual Length	C Drain Depth	Square Drain Highline Custom Kit Order Ref	RRP EX Vat €
221	100 x 100	119	WM82100.K2	€444.00

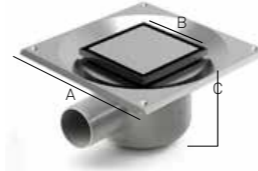
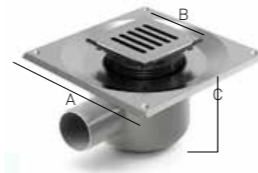
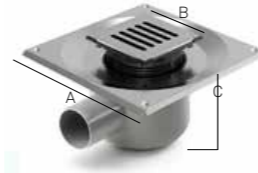
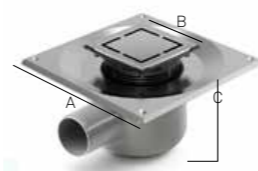

# WM 59 CENTRE DRAIN HORIZONTAL LOW PROFILE



## DESIGN OPTIONS (NO TILE INSERT)

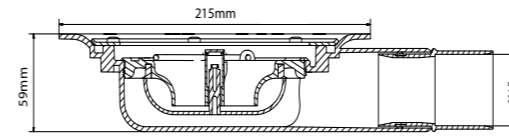

Model No.	A Structural Length	B Visual Length	C Drain Depth	Art Deco Grate Frame Kit Order Ref	RRP EX VAT €	Classic Grate Frame Kit Order Ref	RRP EX VAT €	Drop Grate Frame Kit Order Ref	RRP EX VAT €
SDSD.0059	215	200 X 200	59	SDSD.0059AD	€247.00	SDSD.0059CL	€247.00	SDSD.0059DR	€247.00

# UNIDRAIN® SQUARE

## VERTICAL

A Structural Length	B Visual Length	C Drain Depth	Square Drain Anniversario Kit Order Ref	RRP EX Vat €
221	100 x 100	186	WM82100.K1M01	€444.00

CHECK STOCK AVAILABILITY ON ANNIVERSARIO

A Structural Length	B Visual Length	C Drain Depth	Square Drain Column kit Order Ref	RRP EX Vat €
221	100 X 100	186	WM82100.K1COM01	€444.00

A Structural Length	B Visual Length	C Drain Depth	Square Drain Column Kit Order Ref	RRP EX Vat €
221	150 x 150	186	WM82150.K1COM01	€457.00

A Structural Length	B Visual Length	C Drain Depth	Square Drain Highline Custom Kit Order Ref	RRP EX Vat €
221	100 x 100	186	WM82100.K2M01	€444.00

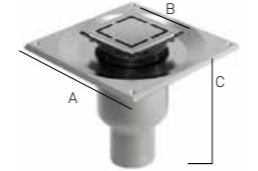

Hook  
Order Ref  
**WM1840.0000**  
RRP EX VAT  
**€21.00**



### DESIGN OPTIONS

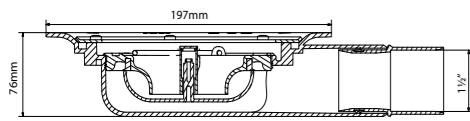

Model No.	A Structural Length	B Visual Length	C Drain Depth	Art Deco Grate Frame Kit Order Ref	RRP EX VAT €	Classic Grate Frame Kit Order Ref	RRP EX VAT €	Drop Grate Frame Kit Order Ref	RRP EX VAT €	Tile Insert Frame Kit Order Ref	RRP EX VAT €
SDSD.0076	197	145 X 145	76	SDSD.0076AD	€173.00	SDSD.0076CL	€173.00	SDSD.0076DR	€173.00	SDSD.0076TI	€173.00

Steel Tile Insert Kit Order Ref	RRP EX VAT €	Black Tile Insert Kit Order Ref	RRP EX VAT €	Brass Tile Insert Kit Order Ref	RRP EX VAT €	Nickel Tile Insert Kit Order Ref	RRP EX VAT €	Bronze Tile Insert Kit Order Ref	RRP EX VAT €
SDSD.0076SS	€173.00	SDSD.0076BL	€438.00	SDSD.0076BS	€374.00	SDSD.0076NI	€374.00	SDSD.0076BZ	€374.00

Steel Panel Kit Order Ref	RRP EX VAT €	Black Panel Kit Order Ref	RRP EX VAT €	Brass Panel Kit Order Ref	RRP EX VAT €	Nickel Panel Kit Order Ref	RRP EX VAT €	Bronze Panel Kit Order Ref	RRP EX VAT €
SDSD.0076SS	€173.00	SDSD.0076BL	€438.00	SDSD.0076BS	€374.00	SDSD.0076NI	€374.00	SDSD.0076BZ	€374.00



Wooden Floor Mounting Set  
Order Ref  
**WMSD.MS**  
RRP EX VAT  
**€75.00**



Hook  
Order Ref  
**WM1840.0000**  
RRP EX VAT  
**€21.00**

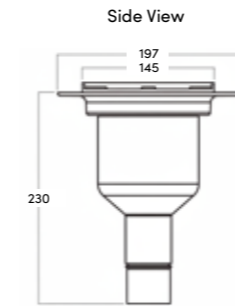

### DESIGN OPTIONS

Model No.	A Structural Length	B Visual Length	C Drain Depth	Art Deco Grate Frame Kit Order Ref	RRP EX VAT €	Classic Grate Frame Kit Order Ref	RRP EX VAT €	Drop Grate Frame Kit Order Ref	RRP EX VAT €	Tile Insert Frame Kit Order Ref	RRP EX VAT €
SDSD.0189	197	145 x 145	230	SDSD.0189AD	€186.00	SDSD.0189CL	€186.00	SDSD.0189DR	€186.00	SDSD.0189TI	€186.00

Steel Tile Insert Kit Order Ref	RRP EX VAT €	Black Tile Insert Kit Order Ref	RRP EX VAT €	Brass Tile Insert Kit Order Ref	RRP EX VAT €	Nickel Tile Insert Kit Order Ref	RRP EX VAT €	Bronze Tile Insert Kit Order Ref	RRP EX VAT €
SDSD.0189SS	€186.00	SDSD.0189BL	€450.00	SDSD.0189BS	€386.00	SDSD.0189NI	€386.00	SDSD.0189BZ	€386.00

Steel Panel Kit Order Ref	RRP EX VAT €	Black Panel Kit Order Ref	RRP EX VAT €	Brass Panel Kit Order Ref	RRP EX VAT €	Nickel Panel Kit Order Ref	RRP EX VAT €	Bronze Panel Kit Order Ref	RRP EX VAT €
SDSD.0189SS	€186.00	SDSD.0189BL	€450.00	SDSD.0189BS	€386.00	SDSD.0189NI	€386.00	SDSD.0189BZ	€386.00



Wooden Floor Mounting Set  
Order Ref  
**WMSD.MS**  
RRP EX VAT  
**€75.00**



Hook  
Order Ref  
**WM1840.0000**  
RRP EX VAT  
**€21.00**

# UNIDRAIN GLASSLINE

GLASSLINE BASE. GLASS SOLD SEPARATELY.



## RIGHT-ALIGNED SHOWER SCREEN DESIGN OPTIONS



Size A	Size B	Depth	Anniversario Grate and 12mm Frame Kit Order Ref		Highline Custom Kit Order Ref		Highline Panel and 15mm Frame Kit Order Ref		Highline Cassette and 15mm Frame Kit Order Ref	
			Kit Order Ref	RRP Ex VAT €	Kit Order Ref	RRP Ex VAT €	Kit Order Ref	RRP Ex VAT €	Kit Order Ref	RRP Ex VAT €
800	800	105	5002.0808K1	€1,424.00	5002.0808K2	€1,487.00	5002.0808K3	€1,828.00	5002.0808K4	€1,768.00
800	900	105	5002.0809K1	€1,472.00	5002.0809K2	€1,534.00	5002.0809K3	€1,875.00	5002.0809K4	€1,817.00
800	1000	105	5002.0810K1	€1,479.00	5002.0810K2	€1,540.00	5002.0810K3	€1,881.00	5002.0810K4	€1,824.00
800	1200	105	5002.0812K1	€1,545.00	5002.0812K2	€1,608.00	5002.0812K3	€1,949.00	5002.0812K4	€1,889.00
900	800	106	5002.0908K1	€1,479.00	5002.0908K2	€1,548.00	5002.0908K3	€1,916.00	5002.0908K4	€1,853.00
900	900	106	5002.0909K1	€1,479.00	5002.0909K2	€1,548.00	5002.0909K3	€1,916.00	5002.0909K4	€1,853.00
900	1000	106	5002.0910K1	€1,487.00	5002.0910K2	€1,556.00	5002.0910K3	€1,923.00	5002.0910K4	€1,861.00
900	1200	106	5002.0912K1	€1,551.00	5002.0912K2	€1,622.00	5002.0912K3	€1,988.00	5002.0912K4	€1,927.00
1000	900	108	5002.1009K1	€1,545.00	5002.1009K2	€1,622.00	5002.1009K3	€2,004.00	5002.1009K4	€1,944.00
1000	1000	108	5002.1010K1	€1,560.00	5002.1010K2	€1,636.00	5002.1010K3	€2,018.00	5002.1010K4	€1,960.00
1000	1200	108	5002.1012K1	€1,703.00	5002.1012K2	€1,780.00	5002.1012K3	€2,161.00	5002.1012K4	€2,101.00



## LEFT-ALIGNED SHOWER SCREEN DESIGN OPTIONS



Size A	Size B	Depth	Anniversario Grate and 12mm Frame Kit Order Ref		Highline Custom Kit Order Ref		Highline Panel and 15mm Frame Kit Order Ref		Highline Cassette and 15mm Frame Kit Order Ref	
			Kit Order Ref	RRP Ex VAT €	Kit Order Ref	RRP Ex VAT €	Kit Order Ref	RRP Ex VAT €	Kit Order Ref	RRP Ex VAT €
800	800	105	5003.0808K1	€1,424.00	5003.0808K2	€1,487.00	5003.0808K3	€1,828.00	5003.0808K4	€1,768.00
800	900	105	5003.0809K1	€1,472.00	5003.0809K2	€1,534.00	5003.0809K3	€1,875.00	5003.0809K4	€1,817.00
800	1000	105	5003.0810K1	€1,479.00	5003.0810K2	€1,540.00	5003.0810K3	€1,881.00	5003.0810K4	€1,824.00
800	1200	105	5003.0812K1	€1,545.00	5003.0812K2	€1,608.00	5003.0812K3	€1,949.00	5003.0812K4	€1,889.00
900	800	106	5003.0908K1	€1,479.00	5003.0908K2	€1,548.00	5003.0908K3	€1,916.00	5003.0908K4	€1,853.00
900	900	106	5003.0909K1	€1,479.00	5003.0909K2	€1,548.00	5003.0909K3	€1,916.00	5003.0909K4	€1,853.00
900	1000	106	5003.0910K1	€1,487.00	5003.0910K2	€1,556.00	5003.0910K3	€1,923.00	5003.0910K4	€1,861.00
900	1200	106	5003.0912K1	€1,551.00	5003.0912K2	€1,622.00	5003.0912K3	€1,988.00	5003.0912K4	€1,927.00
1000	900	108	5003.1009K1	€1,545.00	5003.1009K2	€1,622.00	5003.1009K3	€2,004.00	5003.1009K4	€1,944.00
1000	1000	108	5003.1010K1	€1,560.00	5003.1010K2	€1,636.00	5003.1010K3	€2,018.00	5003.1010K4	€1,960.00
1000	1200	108	5003.1012K1	€1,703.00	5003.1012K2	€1,780.00	5003.1012K3	€2,161.00	5003.1012K4	€2,101.00

# UNIDRAIN GLASSLINE

GLASSLINE BASE. GLASS SOLD SEPARATELY.



Size A	Size B	Depth	Highline Panel and 15mm Frame Brass Kit Order Ref		Highline Panel and 15mm Frame Copper Kit Order Ref		Highline Panel and 15mm Frame Black Kit Order Ref		Highline Panel and 15mm Frame Polished Stainless Steel Kit Order Ref	
			Kit Order Ref	RRP Ex VAT €	Kit Order Ref	RRP Ex VAT €	Kit Order Ref	RRP Ex VAT €	Kit Order Ref	RRP Ex VAT €
800	800	105	5002.0808K5	€2,172.00	5002.0808K6	€2,172.00	5002.0808K7	€2,238.00	5002.0808K8	€2,172.00
800	900	105	5002.0809K5	€2,219.00	5002.0809K6	€2,219.00	5002.0809K7	€2,235.00	5002.0809K8	€2,219.00
800	1000	105	5002.0810K5	€2,228.00	5002.0810K6	€2,228.00	5002.0810K7	€2,293.00	5002.0810K8	€2,228.00
800	1200	105	5002.0812K5	€2,293.00	5002.0812K6	€2,293.00	5002.0812K7	€2,359.00	5002.0812K8	€2,293.00
900	800	106	5002.0908K5	€2,264.00	5002.0908K6	€2,264.00	5002.0908K7	€2,329.00	5002.0908K8	€2,264.00
900	900	106	5002.0909K5	€2,264.00	5002.0909K6	€2,264.00	5002.0909K7	€2,329.00	5002.0909K8	€2,264.00
900	1000	106	5002.0910K5	€2,271.00	5002.0910K6	€2,271.00	5002.0910K7	€2,338.00	5002.0910K8	€2,271.00
900	1200	106	5002.0912K5	€2,338.00	5002.0912K6	€2,338.00	5002.0912K7	€2,403.00	5002.0912K8	€2,338.00
1000	900	108	5002.1009K5	€2,538.00	5002.1009K6	€2,538.00	5002.1009K7	€2,620.00	5002.1009K8	€2,538.00
1000	1000	108	5002.1010K5	€2,552.00	5002.1010K6	€2,552.00	5002.1010K7	€2,634.00	5002.1010K8	€2,552.00
1000	1200	108	5002.1012K5	€2,697.00	5002.1012K6	€2,697.00	5002.1012K7	€2,777.00	5002.1012K8	€2,697.00



Size A	Size B	Depth	Highline Panel and 15mm Frame Brass Kit Order Ref		Highline Panel and 15mm Frame Copper Kit Order Ref		Highline Panel and 15mm Frame Black Kit Order Ref		Highline Panel and 15mm Frame Polished Stainless Steel Kit Order Ref	
			Kit Order Ref	RRP Ex VAT €	Kit Order Ref	RRP Ex VAT €	Kit Order Ref	RRP Ex VAT €	Kit Order Ref	RRP Ex VAT €
800	800	105	5003.0808K5	€2,172.00	5003.0808K6	€2,172.00	5003.0808K7	€2,238.00	5003.0808K8	€2,172.00
800	900	105	5003.0809K5	€2,219.00	5003.0809K6	€2,219.00	5003.0809K7	€2,235.00	5003.0809K8	€2,219.00
800	1000	105	5003.0810K5	€2,228.00	5003.0810K6	€2,228.00	5003.0810K7	€2,293.00	5003.0810K8	€2,228.00
800	1200	105	5003.0812K5	€2,293.00	5003.0812K6	€2,293.00	5003.0812K7	€2,359.00	5003.0812K8	€2,293.00
900	800	106	5003.0908K5	€2,264.00	5003.0908K6	€2,264.00	5003.0908K7	€2,329.00	5003.0908K8	€2,264.00
900	900	106	5003.0909K5	€2,264.00	5003.0909K6	€2,264.00	5003.0909K7	€2,329.00	5003.0909K8	€2,264.00
900	1000	106	5003.0910K5	€2,271.00	5003.0910K6	€2,271.00	5003.0910K7	€2,338.00	5003.0910K8	€2,271.00
900	1200	106	5003.0912K5	€2,338.00	5003.0912K6	€2,338.00	5003.0912K7	€2,403.00	5003.0912K8	€2,338.00
1000	900	108	5003.1009K5	€2,538.00	5003.1009K6	€2,538.00	5003.1009K7	€2,620.00	5003.1009K8	€2,538.00
1000	1000	108	5003.1010K5	€2,552.00	5003.1010K6	€2,552.00	5003.1010K7	€2,634.00	5003.1010K8	€2,552.00
1000	1200	108	5003.1012K5	€2,697.00	5003.1012K6	€2,697.00	5003.1012K7	€2,777.00	5003.1012K8	€2,697.00

# UNIDRAIN GLASSLINE

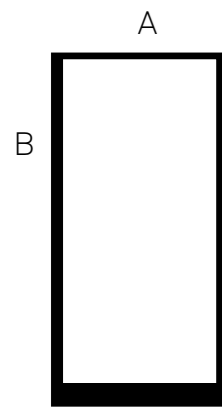

## BLACK POWDER COATED FRAME



CAN BE RIGHT- OR LEFT-ALIGNED

A Shower Screen Length	B Shower Screen Height	Black Kit Order Ref	RRP EX VAT €
800	2104	5117.0800	€1,274.00
900	2104	5117.0900	€1,317.00
1000	2104	5117.1000	€1,362.00

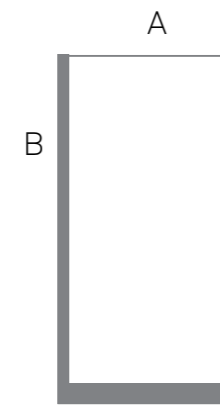

## STAINLESS STEEL



CAN BE RIGHT- OR LEFT-ALIGNED

A Shower Screen Length	B Shower Screen Height	Transparent Kit Order Ref	RRP EX VAT €
800	2104	5100.0800	€1,421.00
900	2104	5100.0900	€1,468.00
1000	2104	5100.1000	€1,760.00
1200	2104	5100.1200	€1,949.00

**DELIVERY NOT INCLUDED IN PRICE PLEASE CONTACT US**

# UNIDRAIN GLASSLINE ACCESSORIES



Model No	Width	Height	Glass Door Order Ref	RRP EX Vat €
800	776	2023	5400.0800	€1,190.00
900	876	2023	5400.0900	€1,267.00
1000	976	2023	5400.1000	€1,362.00



Model No	Right Bar Order Ref	Left Bar Order Ref	RRP EX VAT €
700	5310.1202	5310.1203	€783.00
800	5310.1202	5310.1203	€783.00
900	5310.1202	5310.1203	€783.00
1000	5310.1202	5310.1203	€783.00
1200	5310.1202	5310.1203	€783.00

# UNIDRAIN SHOWERLINE

## RIGHT-ALIGNED SHOWER SCREEN



## LEFT-ALIGNED SHOWER SCREEN

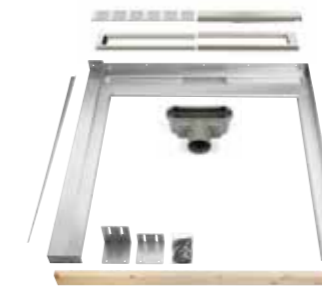

## RIGHT-ALIGNED SHOWER SCREEN

Size A	B	Depth	Anniversario Grate and 12mm Frame Kit Order Ref	RRP EX VAT €	Highline Custom Kit Order Ref	RRP EX VAT €	Highline Panel and 15mm Frame Kit Order Ref	RRP EX VAT €	Highline Cassette and 15mm Frame Kit Order Ref	RRP EX VAT €
800	900	105	5022.0809K1	€1,472.00	5022.0809K2	€1,534.00	5022.0809K3	€1,875.00	5022.0809K4	€1,817.00
900	900	106	5022.0909K1	€1,479.00	5022.0909K2	€1,548.00	5022.0909K3	€1,916.00	5022.0909K4	€1,853.00

Size A	B	Depth	Highline Panel and 15mm Frame Brass Kit Order Ref	RRP EX VAT €	Highline Panel and 15mm Frame Copper Kit Order Ref	RRP EX VAT €	Highline Panel and 15mm Frame Polished Stainless Steel Kit Order Ref	RRP EX VAT €	Highline Panel and 15mm Frame Polished Stainless Steel Kit Order Ref	RRP EX VAT €
800	900	105	5022.0809K5	€2,219.00	5022.0809K6	€2,219.00	5022.0809K7	€2,285.00	5022.0809K8	€2,219.00
900	900	106	5022.0909K5	€2,264.00	5022.0909K6	€2,264.00	5022.0909K7	€2,329.00	5022.0909K8	€2,264.00

## LEFT-ALIGNED SHOWER SCREEN

Size A	B	Depth	Anniversario Grate and 12mm Frame Kit Order Ref	RRP EX VAT €	Highline Custom Kit Order Ref	RRP EX VAT €	Highline Panel and 15mm Frame Kit Order Ref	RRP EX VAT €	Highline Cassette and 15mm Frame Kit Order Ref	RRP EX VAT €
800	900	105	5023.0809K1	€1,472.00	5023.0809K2	€1,534.00	5023.0809K3	€1,875.00	5023.0809K4	€1,817.00
900	900	106	5023.0909K1	€1,479.00	5023.0909K2	€1,548.00	5023.0909K3	€1,916.00	5023.0909K4	€1,853.00

Size A	B	Depth	Highline Panel and 15mm Frame Kit Order Ref	RRP EX VAT €	Highline Panel and 15mm Frame Copper Kit Order Ref	RRP EX VAT €	Highline Panel and 15mm Frame Polished Stainless Steel Kit Order Ref	RRP EX VAT €	Highline Panel and 15mm Frame Polished Stainless Steel Kit Order Ref	RRP EX VAT €
800	900	105	5022.0809K5	€2,219.00	5022.0809K6	€2,219.00	5022.0809K7	€2,285.00	5022.0809K8	€2,219.00
900	900	106	5022.0909K5	€2,264.00	5022.0909K6	€2,264.00	5022.0909K7	€2,329.00	5022.0909K8	€2,264.00

# WALL NICHES

High density Polystyrene with reinforced Cement coating and sealed gasket.  
Ready for tiling recesses for bathrooms and showers. Ideal for light installation.

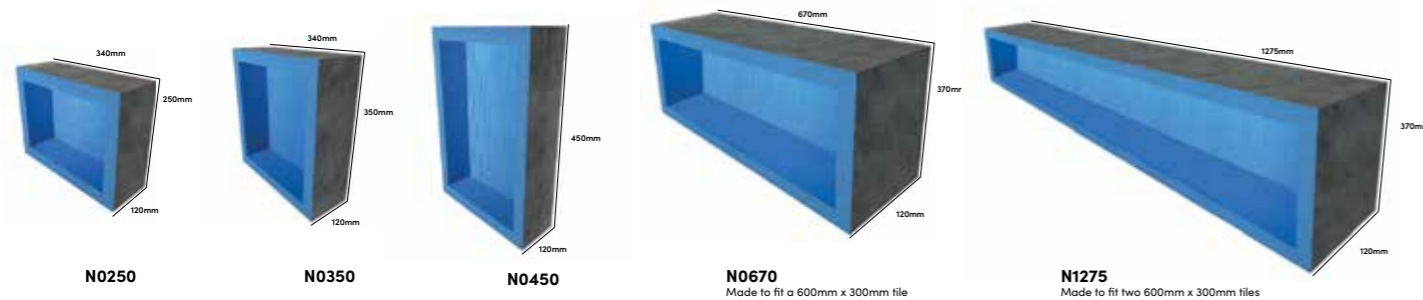

Product Code	External Dimensions	Internal Dimensions	RRP EX VAT €
N0250	250 x 340 x 120mm	190 x 280 x 110mm	€97.00
N0350	350 x 340 x 120mm	290 x 280 x 110mm	€103.00
N0450	450 x 340 x 120mm	390 x 280 x 110mm	€110.00
N0670	670 x 370 x 120mm	610 x 310 x 110mm	€220.00
N1275	1275 x 370 x 120mm	1215 x 310 x 110mm	€227.00

# S-Bench®

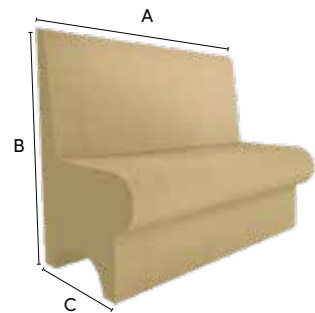

COPENHAGEN  
SBCC12

OSLO  
SBOC12

STOCKHOLM  
SBSC12

Model No.	A Length	B Height	C Width	Sides Coated Order Ref	RRP EX VAT €	Sides Uncoated Order Ref	RRP EX VAT €
Copenhagen	1200mm	964mm	600mm	SBCC12	€1206.00	SBCU12	€959.00
Oslo	1200mm	445mm	500mm	SBOC12	€952.00	SBOU12	€704.00
Stockholm	1200mm	507mm	483mm	SBSC12	€1052.00	SBSU12	€804.00

DELIVERY NOT INCLUDED IN PRICE PLEASE CONTACT US

Bench Installation Kit  
Tile Adhesive, Glue,  
Tanking Kit  
**WMSB.IK**  
RRP EX VAT  
**€165.00**

# ACCESSORIES



Product Name	Description	Order Reference
12kg Tanking Kit Kit includes: Waterproofing Membrane 25m Reinforcement Tape 1Ltr Primer	Easy paint on application approved for wooden, cementitious, metal and plastic surfaces. Coverage 12sqm. <ul style="list-style-type: none"><li>• EC1 Plus Approved</li><li>• Low emissions</li><li>• Primer, 25m tape and membrane</li></ul>	WMVS30.12K RRP EX VAT €167.00 Extra Delivery Cost May Apply



Product Name	Description	Order Reference
3kg Tanking Kit Kit includes: Waterproofing Membrane 25m Reinforcement Tape 1Ltr Primer	Easy paint on application approved for wooden, cementitious, metal and plastic surfaces. Coverage 3sqm. <ul style="list-style-type: none"><li>• EC1 Plus Approved</li><li>• Low emissions</li><li>• Primer, 25m tape and membrane</li></ul>	WMVS30.03K RRP EX VAT €81.00 Extra Delivery Cost May Apply



Product Name	Description	Order Reference
Reinforcement Tape	Reinforcement tape to be used with LIPVS30 on all joints and around first fixes. 25 metres of tape.	WMT25 RRP EX VAT €17.00



Product Name	Description	Order Reference
Internal Corner Ref	LIP preformed reinforcement tape is used to secure the internal/External corners. This is used with LIPVS30.	WMICP RRP EX VAT €15.00
External Corner Ref		WMECP RRP EX VAT €15.00



Product Name	Description	Order Reference
20kg Installation Adhesive	C2TE Adhesive. Used for sheet membrane, SharpSlope Tray and PureStep and tiling installation. EC1 Plus Approved.	WM527 RRP EX VAT €53.00 Extra Delivery Cost May Apply



Product Name	Description	Order Reference
Wetroom Screed	For creating slopes in a wetroom. <ul style="list-style-type: none"><li>• 20kg Bag</li><li>• Cement based, tension free and fibre reinforced screed</li><li>• Works from 2mm thickness</li><li>• Coverage 1.8kg per m2 at 1mm thickness</li></ul>	WM226 RRP EX VAT €42.00 Extra Delivery Cost May Apply



Product Name	Description	Order Reference	RRP EX VAT Per Board
SharpBoard® 6mm	Lightweight high-density construction board designed for wetrooms and bathrooms.	SB06M	€18.00
SharpBoard® 10mm	<ul style="list-style-type: none"> <li>1200 x 600mm</li> <li>Waterproof</li> </ul>	SB10M	€20.00
SharpBoard® 12.5mm	<ul style="list-style-type: none"> <li>Insulation Properties improves heat retention</li> </ul>	SB12.5M	€23.00
SharpBoard® 20mm	<ul style="list-style-type: none"> <li>Maximises underfloor heating performance</li> </ul>	SB20M	€26.00
SharpBoard® 30mm	<ul style="list-style-type: none"> <li>Ideal for tiles, synthetic renders and decorative plaster</li> </ul>	SB30M	€32.00



Product Name	Description	Order Reference
Linear Drain Strainer	Prevents the drain from becoming clogged and makes it easier to clean as you don't have to remove the trap.	WM1810.0010
		RRP EX VAT
		€25.00



Product Name	Description	Order Reference
Corner Drain Strainer	Prevents the drain from becoming clogged and makes it easier to clean as you don't have to remove the trap.	WM2811.0010
		RRP EX VAT
		€25.00



Product Name	Description	Order Reference
Cleaning Hook	To lift drain cover and the trap from the outlet for cleaning.	WM1840.0000
		RRP EX VAT
		€21.00



Product Name	Description	Order Reference
Soap Shelf	Brushed stainless steel linear design with an easy to clean removable grate. No screws are required as the shelf is installed between the tiles. Must be placed between two walls.	WM1850.0302
		RRP EX VAT
		€161.00



Product Name	Description	Order Reference
Soap Shelf	Brushed stainless steel corner design with an easy to clean removable grate. No screws are required as the shelf is installed between the tiles. Must be placed between two walls.	WM2850.0201
		RRP EX VAT
		€161.00

## INSTALLATION KIT

The LIP installation kit comes with all the components you need to complete your wetroom installation.

### Kit Includes

- 2 x 20kg bag of specialist wet room tile adhesive.
- Coverage: 2.5kg per m2 at 1mm thickness depending on tiles.
- Two internal corner pieces to reinforce corner joints.
- Preformed collar for waterproofing around pipework

Order Reference

WMSSIK

RRP EX VAT

€146.00

Extra Delivery Cost May Apply



## MAINTENANCE KIT

We recommend you clean your wetroom drain thoroughly at least every 6-8 weeks to improve longevity. The maintenance kit comes with everything you need to look after your wet room.

### Kit includes

- The hook allows you to lift the grate without causing any damage.
- The strainer helps keep the drain clear and is easy to wipe clean.
- WM Cleanser removes lime scale and grease.
- WM Polish treats chrome, stainless steel, tiles and sanitary ware to give a perfect finish.
- WM Grout Sealer should be regularly used to seal grout lines so they cannot absorb water.
- One cloth for cleaning the drain, sanitary ware and tiles.
- One cloth for streak free glass.

Do not use cleaning agents with a high concentration of fluorine, chlorine or hydrogen peroxide.

Order Reference

With 1 Strainer

WMMK

RRP EX VAT

€210.00

Order Reference

With 2 Strainers

WMMK.2

RRP EX VAT

€235.00

For 1400, 1600, 1800, 2000 and 2400 model Wall Mounted Linear Unidrains, an Extra strainer is required. Order reference WMMK.2



NO HARMFUL CHEMICALS  
100% ENVIRONMENTALLY FRIENDLY  
BIODEGRADABLE

**wm**  
wetroom materials

WM | Wetroom Materials  
Unit E1  
Ballymount Ind Est  
Walkinstown  
Dublin  
Co. Dublin  
D12 WR60  
Ireland  
+353 (0)1 2973488

WM | Wetroom Materials  
Unit 3  
Heritage Business Centre  
Derby Road  
Belper  
Derbyshire  
DE56 1SW  
England  
+44 (0) 1332 840 820

[sales@wetroommaterials.com](mailto:sales@wetroommaterials.com)  
[www.wetroommaterials.com](http://www.wetroommaterials.com)

FOR UP TO DATE PRICE LIST



[www.wetroommaterials.com/pricelist](http://www.wetroommaterials.com/pricelist)